

# **REPORT on the 1992 U.S. TOUR of EUROPEAN CONCRETE HIGHWAYS**

TESTING AND RESEARCH SECTION  
CONSTRUCTION AND TECHNOLOGY DIVISION  
RESEARCH REPORT NO. RC-1464

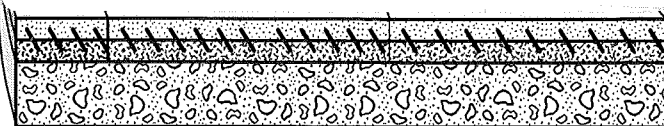

**France • Austria • Germany • Netherlands • Belgium**

**AASHTO   ACPA   FHWA   PCA   SHRP   TRB**

10/10/10

#### NOTICE

This document is printed and disseminated by the Federal Highway Administration in the interest of information exchange. The United States Government assumes no liability for its contents or use thereof. The United States Government does not endorse products or manufacturers. Trademarks or manufacturers' names appear herein only because they are considered essential to the object of this document.

LIBRARY COPY  
DO NOT REMOVE

## Report on the 1992

# U S Tour of European Concrete Highways

--- US TECH ---

*"When all is said and done, the main unifying factor was the political one, summed up in the famous dictum: 'All roads lead to Rome.' The 53,638 or so miles of main roads forming as they did the line of advance for army and commerce, the binding force between races and cultural influences, and the essential basis for the settlement and development of land and its colonisation and survey, served to unify the Roman world and so, at long remove, to create modern Europe."*

Roman Roads  
Raymond Chevallier  
University of California Press  
1976

## **SPONSORING ORGANIZATIONS**

**American Association of State Highway and Transportation Officials**

**American Concrete Pavement Association**

**Federal Highway Administration**

**Portland Cement Association**

**Strategic Highway Research Program**

**Transportation Research Board**

## **ACKNOWLEDGMENT**

The sponsors and members of the U.S. Tour of European Concrete Highways (US TECH) team express their sincere appreciation and thanks to their many colleagues in France, Austria, Germany, Netherlands, Belgium, Spain, Portugal, Switzerland and Italy who were extremely helpful in many ways in explaining their concrete pavement technology. Many thanks also to the staff of CEMBUREAU who made presentations and helped organize the trip. Appreciation is expressed to Mr. John Sullivan of the Federal Highway Administration and Mr. Herb Harris of Sato Travel for assisting with the travel arrangements that were as smooth as a new concrete pavement with a low-noise surface. Special appreciation is expressed to Dr. Michael Darter and other Study Tour members for the preparation of this report.

**Joint Statement by Members  
of the  
1992 U.S. TOUR OF EUROPEAN CONCRETE HIGHWAYS  
(U.S. TECH)**

The United States' highway system ties our nation together and provides the mobility needed to support our economy and everyday activities.

An important part of any highway is the pavement structure upon which we drive. While they have given us good service, the driving surfaces and supporting foundations of pavements on highways across America are wearing out, because of age, traffic volumes larger than projected, and truck loads heavier than expected. As a Nation we face the need to rebuild these pavements, many of which are constructed of portland cement concrete.

To better prepare for the task of rebuilding our highways we came together to examine some of Europe's major freeways and to talk with the experts who design, construct and maintain them, seeking knowledge of practices and experience that might aid us in the United States. Drawn from our Federal and State highway agencies, the American Association of State Highway and Transportation Officials, the Transportation Research Board, the Strategic Highway Research Program, the Portland Cement Association, and the American Concrete Pavement Association and some of its contractor members, our Group of 21 highway and pavement experts observed highways and met with experts in France, Austria,

Germany, the Netherlands, and Belgium. We also had presentations by experts from four other nations, Italy, Portugal, Spain, and Switzerland, concerning portland cement concrete pavements in their countries.

The 21 participants adopted the following Mission Statement for their tour:

The mission of the group is to review the European concrete pavement experience and obtain information relating to finance, research, design, construction, maintenance and performance to assist with development of appropriate actions for enhancing our nation's highway system, productivity and economic future.

### Findings

What did we find in Europe?

We found that the new and recently built portland cement concrete highways we observed are constructed with a common philosophy -- worry more about design, materials and construction excellence and less about cost. These highways featured well-conceived, durable concrete slabs placed on thick, well-drained bases, resulting in superior pavement structures.

The European pavements we observed were built with the best technology available, much of which has been developed in the United States.

We found a cooperative attitude among the various components of the European highway community - researchers, government engineers, contractors, suppliers and others, and a commitment to excellence.

These nations are building their portland cement concrete highways for the future with a 30- to 40-year designed service life compared to our 20 years. Their highways carry a large volume of trucks, with allowable axle weights substantially above those in the United States.

We found a commitment to early, preventive maintenance in Europe, and to undertaking timely rehabilitation and reconstruction.

In summary, Europeans are building excellent concrete pavement systems, and they are building and rebuilding their highways for very large loads and long life.

Should we be concerned about this European strategy? Yes, because Europe will be able to use those highways to better compete in the world economy. And yes, because better pavements will improve our mobility and efficiency, and help us to compete better economically.

Can the United States have better pavements? Yes, if we will commit the necessary resources to achieve

excellence. We have the technical "know-how" and construction techniques in the United States to meet and exceed anything we saw in Europe.

#### Action Plan

A full report on the results of our tour has been prepared. At this time we urge consideration of the following initial steps to help ensure world-class pavement structures in the United States:

- Commit to further improvement of our cement concrete pavement design, materials, and construction technology and equipment through innovation, research, and training.
- Develop a conceptual design catalog, similar to that employed by European Agencies, as a guide to help highway agencies and contractors focus on the best practices.
- Establish at the national level a focal point for collecting and distributing information about developments in the United States and other nations of pavement technology, to pavement engineers, researchers, and the construction industry. This effort should include and could be based upon the continuing SHRP effort, and should include a broad-based advisory board.

- Construct some selected highway projects to explore the applicability of certain European concepts to the United States. The SHRP SPS-2 effort might be employed for at least some projects.
- Organize a continuing training program for pavement engineers from highway agencies and contractors, to improve the design, construction and maintenance of concrete pavements.
- Encourage closer interaction among highway agency engineers, consultants, researchers, industry, and contractors, to promote better concrete pavements.

full-width pavements in Europe, where the emergency lanes or shoulders can be used to temporarily carry heavy truck traffic. This same heavy traffic encourages Europe to construct more maintenance-free highways and to emphasize preventive maintenance. Recycling of pavements is on the rise, with Austria now requiring full recycling on site.

It is for us in the US to take advantage of what we learn from other nations - so that we can anticipate tomorrow's needs and build highways for the future.

## Conclusion

To a significant degree, this tour of Europe offered us a window of issues we in the United States may face tomorrow.

Europe is building highways for more and heavier trucks. They have higher population densities near their highways which are also developing in the United States. These population densities are causing Europe to pay increasing attention to the roadway environment, including construction of pavement to minimize road noise, the widespread use of sound walls, and the extensive use of vegetation in and adjacent to the right-of-way. The need to conduct highway rehabilitation under heavy traffic is resulting in more

## TOUR PARTICIPANTS

### **American Association of State Highway and Transportation Officials**

Mr. Francis B. Francois  
AASHTO

Mr. Robert L. Clevenger  
Colorado Department of Transportation

Mr. Michael Cuddy  
New York Department of  
Transportation

Mr. Donald W. Lucas  
Indiana Department of Transportation

Mr. Wayne Muri  
Missouri Department of Transportation

Mr. Robert L. Walters  
Arkansas Department of  
Transportation

### **Federal Highway Administration**

Mr. Gene McCormick

Mr. Theodore R. Ferragut

Mr. Donald G. Fohs

Mr. John P. Hallin

### **American Concrete Pavement Association**

Mr. William Cape  
James Cape & Sons Company

Mr. Leet E. Denton  
Denton Construction Company

Mr. James A. Duit  
Duit Construction Co., Inc.

Mr. Richard E. Forrestel  
Cold Spring Construction Company

Mr. Irving F. Jensen, Jr.  
Irving F. Jensen Company, Inc.

Mr. Marlin J. Knutson  
American Concrete Pavement  
Association

### **Strategic Highway Research Program**

Dr. Amir Hanna

### **Transportation Research Board**

Mr. Daniel W. Dearasaugh, Jr.

### **Portland Cement Association**

Mr. George Barney

Mr. Larry Cole

### **Trip Reporter**

Dr. Michael I. Darter  
University of Illinois



## TABLE OF CONTENTS

	<b>Sponsoring Organizations</b> .....	<b>ii</b>
	<b>Acknowledgment</b> .....	<b>ii</b>
	<b>Joint Statement by Members of the 1992 U.S. Tour of European Concrete Highways (U.S. TECH)</b> .....	<b>iii</b>
	<b>Tour Participants</b> .....	<b>vi</b>
	<b>Executive Summary</b> .....	<b>viii</b>
<b>1</b>	<b>Introduction</b> .....	<b>1</b>
<b>2</b>	<b>Technical Synthesis</b>	
	2.1 Innovative Concrete Pavement Technology in Europe .....	9
	2.2 Implementation Of Promising Technology in USA .....	38
	2.3 Benefits to the USA of Implementing Innovative Technology .....	47
<b>3</b>	<b>Country Summaries</b>	
	3.1 France .....	48
	3.2 Austria .....	66
	3.3 Germany .....	76
	3.4 Netherlands .....	94
	3.5 Belgium .....	101
	3.6 Other Countries (Spain, Portugal, Italy, Switzerland) .....	112
<b>4</b>	<b>Acronyms, Definitions, Technical Terms</b> .....	<b>123</b>
<b>5</b>	<b>Appendix:</b> .....	<b>124</b>
	<b>Petrographic Report on German Autobahn Concrete Pavement</b>	
	<b>Synoptic Table of European Concrete Pavement Designs</b>	

## EXECUTIVE SUMMARY

The US TECH Study Tour travelled in France, Austria, Germany, the Netherlands, and Belgium, and heard presentations from Spain, Portugal, Switzerland, and Italy. Traveling mostly by motor coach over thousands of kilometers of high-level motorways for 14 days, the Study Tour heard many presentations from government and toll road officials and engineers, contractors, university faculty, and industry representatives, and examined many pavements and construction sites. In addition, helpful literature and technical reports were provided, and many discussions were held with experts from all of these countries, which were very helpful to the Team's understanding of European practice.

The Study Tour members believe Europe represents a "window" through which some important issues concerning the future transportation infrastructure in the USA can be observed.

The most significant findings of this trip as determined by the 21-person Study Tour are briefly summarized in this Executive Summary. The report offers a comparison between Europe and the USA in Section 1. A synthesis of the technical aspects of the Study Tour findings is provided in Section 2. Considerable additional information is given for each country in Section 3.

### Technical Highlights

Europeans are building excellent concrete pavement systems, and

compared to the USA, they are building and rebuilding their highways for very large loads and long life. Many concrete pavement design, construction, and material improvements which USA pavement engineers consider promising innovations for the future are already standard practice in European countries. The following technical highlights explain some of the characteristics of these pavements.

- Traffic Loadings

Truck traffic on European freeways is heavy by American standards in terms of volumes, axle weights, and tire pressures. Truck volumes are similar to those on major routes in the USA but legal axle weights are significantly higher. Single axle legal maximums range from 10 to 13 metric tons (t) (22,046 to 28,660 pounds), compared to 9.1 t (20,000 pounds) in the USA. The EC will apparently adopt a uniform 11.5 t (25,300 pounds) single axle as its legal limit. Tandem axle legal maximums range from 19 to 21 t (41,900 to 46,300 pounds) and tridem axle limits are 24 t (52,900 pounds).

However, actual maximum loads measured are greater than these legal limits. There appears to exist little legal enforcement of weights in Europe. Most trucks observed had super-single tires with high tire pressures. Expectations are that traffic will continue to increase with the economic growth that the EC is expected to bring.

• **Pavement Design**

Jointed plain concrete pavements (JPCP) are constructed most often in Europe and their design has been improved over time through effective research. Continuously reinforced concrete pavements (CRCP) have been built in several countries, most commonly Belgium and France. Design lives are typically 30 to 40 years. The new and rehabilitation designs in most countries are developed by teams of experts and

placed in "pavement design catalogs" for use by project designers. The design catalog approach has several significant benefits, not the least of which is communicating the best practices to the field. Emphasis is on the design of the total pavement system, not just the thickness of the concrete slab. The Study Tour members were impressed with the overall designs from each of the countries. Typical design practice in Europe is summarized below:

Pavement Type	Slab Thickness	JPCP Joint Space	Base	Subbase
JPCP	18-25-30* cm (7-10-12 in)	3.5-5.0-6.0* m (12-17-20 ft) (Dowelled)	Lean concrete	20-90 cm (8-36 in) Granular layer
		<b>CRCP Reinforcement %</b>		
CRCP	17-20-25* cm (6.7-8-10 in)	0.60-0.67-0.85*	Lean concrete AC/LCB**	20-90 cm (8-36 in) Granular layer

---

\* Low - Most Typical - High  
 \*\* Some countries use 5 cm (2 in) AC interlayer between slab and lean concrete base.  
 Some countries bond the JPCP slab to the lean concrete base (which is also jointed).

Note that the slab thicknesses typically do not exceed those in the USA. Other factors are optimized to reduce thickness requirements. Concrete pavements typically have slabs that are 0.5 m (1.7 ft) wider, longitudinal subdrainage pipes and plastic-coated

dowels to control faulting. Austria and Germany are bonding the jointed lean concrete base to the slab to reduce both load-related and environmentally related stresses. Trapezoidal cross-sections are used in two countries to optimize slab design for truck loadings.

The thick granular layer placed beneath the treated base provides a substantial level of bearing capacity, for uniform support, frost heave protection, and subsurface drainage.

Higher reinforcement content in CRCP (0.7 to 0.85 percent) has produced tight cracks and excellent performance. Rectangular, coilable steel strips (product name FLEXARM) for CRCP are innovative and have performed well in France.

A full-width concrete slab and base paving thickness for adequate traffic control needs during future rehabilitation is now provided in some countries. The shoulder is called an "emergency lane."

- Construction

Warranties for pavement construction work are used in Europe. Warranties for concrete pavement range from 4 to 9 years in different countries. The exact requirements and benefits of the warranties need further investigation. Two-layer slab construction is common in some countries for safety, noise and economic reasons. A hard high-quality aggregate is used in the upper 4-7 cm (1.6-2.8 in) of the slab. Two-layer paving equipment is available to place this pavement in one pass. A straight 2.5 percent cross-slope with no crown across traffic lanes is common in new construction. Liquidated damages equalled incentives rate per day for one construction project visited. Lean concrete was used as a temporary widening for traffic control purposes on another project. Reinforcement bar

tubes were placed behind vibrators for CRCP in France to improve steel placement.

- Rehabilitation

Rehabilitation of pavements is performed at a higher level of condition than in the USA. Unbonded CRCP and JPCP overlays are common on old concrete pavements which are often cracked and seated or picked up and crushed and used as base. They are also used on AC pavements. Jointed, steel-fiber-reinforced concrete overlays of existing concrete and AC pavements have been used successfully in Belgium.

Total recycling of concrete and other materials, required by law, was observed on a job site in Austria. Recycled concrete that includes up to 10 percent recycled AC material is used routinely in Austria for economy, and to accommodate its mandatory recycling law. Some interesting lane reconstruction design sections exist and the addition of a 31-cm (12.9 in) CRCP truck lane on an AC pavement was observed. The French LCPC/Freyssinet load transfer device for JPCP is being used to reduce faulting and control reflection cracks under porous asphalt surfaces.

- Concrete Materials

Concrete durability problems do not exist in Europe. Higher-strength concrete is used in several countries. Compressive strengths of 55 MPa (7975 psi) is specified in Belgium at 90 days. Typical flexural strengths of 7.5 MPa

(1,087 psi) in third-point loading at 28 days are specified. A thick (40 cm (15.8 in)) porous concrete slab that provides a free draining non-hydroplaning surface, noise reduction and storm runoff reservoir capabilities has been constructed in Paris. Lean concrete shoulders have proven successful in France.

- **Surfacings**

Reduction of pavement-tire noise levels is an important environmental issue in Europe. Several methods are being used that reduce noise levels yet still provide adequate friction. For new pavements these include longitudinal texturing with a burlap drag with smaller top-sized aggregates, longitudinal texturing produced by a combination of brush and comb achieving both a microtexture and a macrotexture, porous asphalt surfacing (this is very common), porous concrete surfacing (the Netherlands), and exposed aggregate surfaces (these are also very common). Noise reduction treatments for existing pavements include a surface layer of epoxy/fine-grained aggregate, a double surface treatment of polymerized asphalt on the surface with two layers of chips, and diamond grinding of a coarse-textured surface.

- **Research and Development**

Excellent cooperation between government and industry exists in Europe that provides many benefits in terms of increased innovation and implemented research results. Major accelerated field testing of concrete

pavements is underway in France that was very impressive. Their circular track is somewhat comparable to the FHWA ALF but is able to provide many more loadings in a shorter period of time. Most European countries appear to be conducting more pavement research than the USA as a percentage of total funding spent on the highway network. Significant innovation in pavement design, construction and rehabilitation is apparent in several European countries. Significant efforts are made in several countries to implement research findings. The researcher guides the field implementation along with engineers from operations and industry until the procedure or product is working as intended.

- **Engineering Expertise**

Impressive groups of experienced pavement engineers exist in most of the countries visited. It appears that it is the general practice for individuals to make their careers in pavement engineering. Many of these engineers have the ability to travel to international conferences and serve on committees (PIARC and TRB).

- **Toll Road Financing and Engineering**

The Study Tour was very impressed with the French toll road companies. The pavements were in very good condition and the toll road companies appeared to make exceptional efforts to provide a high level of service to toll road users.

## Recommendations

Based upon observations during the study tour, the participants urge the consideration of the following points to help ensure world-class pavement structures in the USA:

- ✓ Commit to continuous improvement of our concrete pavement design, materials, and construction technology and equipment through innovation, research, and training. Increased government and industry cooperative research is urged.
- ✓ Develop a conceptual design catalog, similar to those employed by European agencies, as a guide to help highway agencies and contractors focus on the best practices. Consider using longer design lives for pavement design.
- ✓ Establish at the national level a focal point for collecting and disseminating information about pavement technology developments in the United States and other nations, to pavement engineers, researchers, and the construction industry. This effort should include and could be based upon the continuing SHRP effort, and should include a broad-based advisory board.
- ✓ Construct experimental highway projects to explore the applicability of certain European concepts to the United States. These might include the German JPCP design, and the French coilable reinforcement in CRCP. The SHRP SPS-2 effort might be employed for at least some projects.
- ✓ Organize a continuing training program for pavement engineers from highway agencies and contractors, to improve the design, construction, and maintenance of concrete pavements.
- ✓ Encourage closer interaction among highway agency engineers, consultants, researchers, industry, and contractors, to promote excellence in concrete pavements.

# SI\* (MODERN METRIC) CONVERSION FACTORS

## APPROXIMATE CONVERSIONS FROM SI UNITS

Symbol	When You Know	Multiply By	To Find	Symbol	When You Know	Multiply By	To Find	Symbol
<b>LENGTH</b>								
in	inches	25.4	millimeters	mm	millimeters	0.039	inches	in
ft	feet	0.305	meters	m	meters	3.28	feet	ft
yd	yards	0.914	meters	m	yards	1.09	yards	yd
mi	miles	1.61	kilometers	km	kilometers	0.621	miles	mi
<b>AREA</b>								
in <sup>2</sup>	square inches	645.2	square millimeters	mm <sup>2</sup>	square millimeters	0.0016	square inches	in <sup>2</sup>
ft <sup>2</sup>	square feet	0.093	square meters	m <sup>2</sup>	square meters	10.764	square feet	ft <sup>2</sup>
yd <sup>2</sup>	square yards	0.836	square meters	m <sup>2</sup>	square meters	1.195	square yards	ac
ac	acres	0.405	hectares	ha	hectares	2.47	acres	mi <sup>2</sup>
mi <sup>2</sup>	square miles	2.59	square kilometers	km <sup>2</sup>	square kilometers	0.386	square miles	
<b>VOLUME</b>								
fl oz	fluid ounces	29.57	milliliters	ml	milliliters	0.034	fluid ounces	fl oz
gal	gallons	3.785	liters	l	liters	0.264	gallons	gal
ft <sup>3</sup>	cubic feet	0.028	cubic meters	m <sup>3</sup>	cubic meters	35.71	cubic feet	ft <sup>3</sup>
yd <sup>3</sup>	cubic yards	0.765	cubic meters	m <sup>3</sup>	cubic meters	1.307	cubic yards	yd <sup>3</sup>
<b>MASS</b>								
oz	ounces	28.35	grams	g	grams	0.035	ounces	oz
lb	pounds	0.454	kilograms	kg	kilograms	2.202	pounds	lb
T	short tons (2000 lb)	0.907	megagrams	Mg	megagrams	1.103	short tons (2000 lb)	T
<b>TEMPERATURE (exact)</b>								
°F	Fahrenheit temperature	5(F-32)/9 or (F-32)/1.8	Celsius temperature	°C	Celsius temperature	1.8C + 32	Fahrenheit temperature	°F
<b>ILLUMINATION</b>								
fc	foot-candles	10.76	lux	lx	lux	0.0929	foot-candles	fc
fl	foot-Lamberts	3.426	candela/m <sup>2</sup>	cd/m <sup>2</sup>	candela/m <sup>2</sup>	0.2919	foot-Lamberts	fl
<b>FORCE and PRESSURE or STRESS</b>								
lbf	poundforce	4.45	newtons	N	newtons	0.225	poundforce	lbf
psi	poundforce per square inch	6.89	kilopascals	kPa	kilopascals	0.145	poundforce per square inch	psi

NOTE: Volumes greater than 1000 l shall be shown in m<sup>3</sup>.

\* SI is the symbol for the International System of Units. Appropriate rounding should be made to comply with Section 4 of ASTM E380. (Revised August 1992)

# 1 INTRODUCTION

## Europe and the United States: A Comparison

Geographic, demographic and highway system data for the USA, selected States, and selected European countries are given in Table 1.1, in order of increasing land area. A direct comparison of various European countries and the USA by land area can be made. The land area of these European countries is about 20 percent of the USA and the length of main and national motorways is about 33 percent that of the USA.

- **Population and Roadway Density**

European countries in general have higher population densities than nearly all USA States. For example, the five countries visited by the Study Tour have an average population density of 312 people per square kilometer compared to the USA average 26.

Europe also has over three times more kilometers of roadway per square kilometer than the USA. The USA has on average 0.7 km of highway per square km (1.1 mi per square mi) of land area, while Europe has on average 2.4 km of highway per square km (3.9 mi per square mi) of land area. Some European countries have much more dense highway networks; Austria, for example, has 7.6 km of highway per square km (12.2 mi per square mi).

These statistics are important in understanding the great concern that many European countries have for noise pollution. However, Table 1.2 shows that several northeastern States (Rhode Island, Connecticut and New Jersey) have densities comparable to those of European countries. The following data give a comparison between selected States and countries in Europe having the same population density.

Table 1.2 Comparisons of population and roadway densities.

Country or State	People per sq km	Km Road per sq km
USA	26	0.7
Austria	544	7.6
Netherlands	349	2.7
New Jersey	380	2.7
Belgium	318	4.4
Rhode Island	314	3.0
W. Germany	249	2.0
Connecticut	247	2.4
France	102	1.5
Pennsylvania	102	1.6
Spain	77	0.6
California	67	0.6

$$1 \text{ km}^2 = 0.386 \text{ mi}^2, 1 \text{ km/km}^2 = 1.61 \text{ mi/mi}^2$$



Table 1.1 Road system statistics comparison of the United States and selected European countries.

	Total Land Area (1000 sq km)	Population Density (per sq km)	Road System (thousands km)		Kilometers of Road per Thousand of Population		Kilometers of Road per Square Kilometer of Area		Cars per Thousand of Population	Fatality Rate Deaths per 100 Million veh-km
			Main and National	Secondary and Other	Main and National	Secondary and Other	Urban Area	Total Land Area		
Rhode Island	3	314	1.5	7.9	1.6	8.0	16.6	3.0	551	1.4
Delaware	5	122	1.0	7.6	1.6	11.7	16.6	1.6	591	1.6
Connecticut	13	247	4.6	27.1	1.4	8.4	13.0	2.4	762	1.1
Austria	14	544	11.5	95.0	1.5	12.5	na	7.6	na	na
New Jersey	20	380	9.3	45.5	1.2	5.9	11.6	2.7	646	1.2
Maryland	27	167	6.5	38.5	1.4	8.5	14.6	1.7	599	1.4
Belgium	31	318	14.5	122.4	1.5	12.4	13.0	4.4	350	3.9
Switzerland	41	160	19.8	51.2	3.0	7.7	na	1.7	na	na
Netherlands	42	349	4.4	109.2	0.3	7.4	7.1	2.7	348	1.4
Portugal	92	111	19.1	0.0	1.9	0.0	1.0	0.2	155	6.6
Pennsylvania	117	102	24.7	163.4	2.1	13.7	22.4	1.6	518	1.6
New York	127	140	24.5	153.0	1.4	8.6	24.2	1.4	469	1.6
Florida	152	79	19.3	142.3	1.6	11.8	14.4	1.1	709	1.9
West Germany	249	246	39.8	453.8	0.7	7.4	9.0	2.0	463	2.3
Wyoming	252	2	7.1	57.4	14.5	117.1	107.7	0.3	575	1.2
NY-NJ-PA	265	141	58.4	361.9	1.6	9.7	20.6	1.6	521	1.5
Italy	301	191	51.3	251.2	0.9	4.4	4.8	1.0	423	2.2
California	411	67	44.0	211.7	1.6	7.7	19.4	0.6	568	1.6
Spain	505	77	20.6	297.5	0.5	7.7	3.0	0.6	263	6.9
France	544	102	34.9	770.0	0.6	13.8	9.2	1.5	394	3.0
United States	9400	26	651.9	5581.4	2.7	22.9	2.6	0.7	561	1.5

Most data 1987. Sources: "Europe in Figures," Eurostat, 1989; World Road Statistics, IRF, 1991. Highway Statistics, 1987, U.S. Statistical Abstract, 1991, 1992.

**Table 1.3 Roadway mileage comparisons for European countries and US States of comparable population and roadway densities.**

Europe	Main Motorways (km)	Comparable State	Main Motorways (km)
Austria	11,500		
Netherlands	4,400	New Jersey	9,300
Belgium	14,500	Rhode Island	1,500
West Germany	39,800	Connecticut	4,600
France	34,900	Pennsylvania	24,700
Spain	20,600	California	44,000

1 km = 0.621 mi

- **Highway Network**

A comparison of the main and national motorways of these same countries with various States is given in Table 1.3. The USA has 651,900 km (404,800 miles) of main motorways. The total of 215,900 km (134,100 miles) for all European countries is 33 percent of the USA's mileage.

- **Climate**

Climatic factors have an effect on concrete pavement performance and it is important to have a general understanding of the climates of Europe vs the USA. In general, the climate is milder in most of the countries visited than in the northern USA.

- **Traffic Statistics**

The cars per thousand of population and fatality rate deaths per 100 million

vehicle km travelled are shown for the same countries in Table 1.4. The USA has a significantly larger number of cars per 1000 population, but most European countries (excepting the Netherlands) have far higher fatality rates than the USA.

- **Consequences of Infrastructure Neglect in Eastern Germany**

Travel over thousands of kilometers of European highways clearly showed that those highways (all types of pavements) are in far better condition than most highways in the USA. The serious deterioration that exists on American highways and streets was virtually never seen in Europe. Pavement rehabilitation is applied much earlier so that the traveling public almost never sees serious deterioration or roughness, let alone serious pavement-related hazards.

Table 1.4 Comparisons of vehicle ownership and fatality rates in European countries and US States.

Europe	Cars/1000 Population	Fatality Rate *	Comparable State	Cars/1000 Population	Fatality Rate *
Netherlands	348	1.4	New Jersey	646	1.2
Belgium	350	3.9	Rhode Island	551	1.4
W. Germany	463	2.3	Connecticut	762	1.1
France	394	3.0	Pennsylvania	518	1.6
Spain	263	6.9	California	568	1.6

\* Deaths per 100 million vehicle-km travelled (multiply by 1.61 for deaths per 100 million vehicle-miles.)

The most impressive, never-to-be-forgotten portion of the European Study Tour was the travel and visits in the former East Germany. Driving into the former East Germany presents an immediate dramatic difference in the condition of pavements and other roadside structures from that in the West. The deteriorated condition of many sections of highways was evident immediately upon passing over the former border (with empty guard towers at interchanges) between Munich and Berlin where the entire distance is mostly concrete pavements constructed over 50 years ago.

Simply put, there has been no highway maintenance done in eastern Germany over the past 40 years, which has led to major deterioration of the highway infrastructure to the point that serious mobility, congestion, and safety problems exist and complete expensive reconstruction is the only feasible solution for most sections.

During meetings in Berlin, government officials described how bad the highway pavements were, especially within towns. They get letters and phone calls every day from many people stating that they cannot carry on their normal work because of impassible streets and highways. Teachers cannot teach, police cannot patrol, etc.!

However, it is most interesting to note that the German government is now placing an enormous emphasis on spurring economic recovery in the east through a massive reconstruction of many deteriorated highways. The Study Tour witnessed many of these projects on the drive from Munich to Berlin and then on the freeway ring around Berlin.

The German government's recognition that highways are vital to this recovery, and their action to rehabilitate the highways in the east as the first step in recovery was very impressive to the Study Tour. The Study Tour was told that in the State of Brandenburg (where Berlin is located), 1.2 billion Deutsche Marks (DM) were available this year, some 300 million DM more than they can spend, apparently because not enough contractors are available!

### **Europe, a "Window" to Future Transportation Infrastructure Issues**

Europe seems to represent a "window" through which some important issues of the future transportation infrastructure in the USA can be observed. Some of these already exist in more densely populated and industrial areas of the USA.

- **More and Heavier Trucks and Axle Weights**

For a number of years, European countries have experienced 8 percent or more annual growth in truck volume on freeways. This rate of growth is expected to accelerate in the future with the coming of the European Community (EC). Heavy truck volumes run 20 to 30 percent of average daily traffic (ADT) on many freeways and daily truck volumes run from 1000 to over 10,000 per day in one direction in the outer lane.

The legal axle weights in several countries are summarized in Table 1.5. The EC will apparently adopt a uniform 11.5 metric ton (denoted by t) (25,300 pounds) single axle as its legal limit, which will mean an increase for some countries, but other countries already have a higher limit, such as a 13 t (28,600 pounds) single axle and a 21 t (46,300 pounds) tandem axle in some countries, among the highest in the world. Note that these load limits are far higher than those in the USA. Apparently little enforcement of axle weights exists. One weigh-in-motion site showed that 4 percent of axles were even above these "highest in the world" legal limits. Comparison of the axle load distribution from the 1960's to the 1990's shows a major shift to heavier axle weights.

These weights will make Europe's trucking industry very competitive from a transportation cost standpoint.

- **More Trucks with Super-Single Tires and Higher Tire Pressures**

The trucks in many European countries have super-single tires. These tires were rated at 0.86 MPa (125 psi) tire pressure.

- **Environmental Issues**

Use of existing roadbed construction materials is emphasized. Existing concrete pavement is often cracked or crushed and used as a base for a new concrete pavement or recycled as aggregate in new concrete pavement.

Table 1.5 Legal axle load limits in Europe and USA.

Country	Single Axle		Tandem Axle	
	tons	pounds	tons	pounds
Austria	10	22,046	16	35,300
Belgium	13	28,660	n/a	
France	13	28,660	n/a	
Germany	11.5	25,353	19	41,888
Italy	12	26,455	19	41,888
Netherlands	11.5	25,353	n/a	
Portugal	12	26,455	20	44,092
Spain	13	28,660	21	46,297
Switzerland	8.2	18,077	n/a	
USA	9.1	20,000	15.4	34,000

Recycling all materials at the job site (no land filling) is required in some cases.

Noise emission from pavement-tire interaction is very important at this time in Europe. In fact, pavement-tire noise reduction was one of the most talked-about topics on the tour. Eliminating splash during rainstorms is considered important for safety.

Maintaining high friction is important because the friction value has been related to wet-weather accidents.

- **Reduction of Congestion Through Fewer Lane Closures**

Longer-lasting pavements require fewer lane closures for repair or reconstruction.

Lower pavement maintenance needs require fewer lane closures.

Rapid construction reduces lane closures.

- **Consideration for Future Traffic Control Needs in Design and Rehabilitation**

One side of a typical divided highway (two lanes plus shoulders) consists of

full-width paving thickness that can later be divided into four lanes so that the pavement in the other direction can be closed for reconstruction or rehabilitation, or for emergencies. Note that lanes through construction zones are reduced in width.

- **Emphasis on Level of Service**

The level of service provided by freeway pavements in Europe was observed to be very high. This may be due to a combination of factors including higher investment in the infrastructure (see Figure 1.1), improved designs, more durable materials, and higher construction requirements.

A primary reason for the achievement of quality highways in Europe is a longer original design life and a European mindset for long-term use, not only of highways but also of homes, cars and all other products. Europe is not a disposable-driven economy. Designs include a large safety factor. For example, actual concrete strengths regularly exceed design strengths by a considerable margin, and design strengths used in Europe are considerably higher than ours. USA construction contracts and quality control programs are focused on uniformity and building as closely as possible to specified requirements, whereas their designs and contracts are focused on getting the best, longest-life product possible.

Virtually no concrete durability problems were observed in any country. The comprehensive Swiss quality control (QC) program to achieve durable concrete provides an understanding of how this level of quality is achieved.

Many European concrete pavements built in the 1950's and 1960's have performed extremely well and only recently have some of these pavements required rehabilitation. Other much older concrete pavements exist in Europe, such as the 67-year-old pavement in Brussels, or the East German autobahn concrete pavements which are more than 50 years old (although traffic was not heavy for many years). Even now these pavements do not exhibit any durability problems, though they do show cracking and faulting problems. Many kilometers of concrete pavements built in Portugal between 1935 and 1945 are all still in service. Austria has many jointed concrete pavements that are over 30 years old that have performed very well.

- **Cooperation of Government and Industry in Research**

Europe benefits greatly from close cooperation between public and private organizations. An ideal example is the French national research study on concrete pavements. These type of relationships are growing in the USA as well. In fact, close cooperation

among industry, State, and Federal officials is one of the reasons that this tour took place.

During the European Study Tour, the participants freely discussed many aspects of transportation facilities. The participants felt that this interaction between Federal, State, and industry personnel was extremely valuable and contributed greatly to increased understanding.

## 2 TECHNICAL SYNTHESIS

### 2.1 Innovative Concrete Pavement Technology in Europe

The US TECH Study Tour observed many interesting and innovative ideas, technologies, procedures, equipment and processes related to concrete pavements that will be of interest to engineers and administrators in the USA. Many of these have been researched in the USA before but have not been widely implemented.

### Pavement Design

A summary of typical designs for freeway type highways is shown in Table 2.1. Several countries are also building unbonded CRCP or JPCP overlays over existing concrete pavements. A summary of European practices for concrete pavements is reproduced in the Appendix.

Table 2.1 Summary of concrete pavement designs for countries visited.

Country	Slab	Joints*	Base**	Subbase
France	CRCP 17-25 cm (6.7-10 in)	---	LCB	n/a
	JPCP 22-28 cm (8.7-11 in)	4-5.5 m (13.1-18 ft)	LCB	n/a
Austria	JPCP 18-25 cm (7-10 in)	5.5-6 m (18-19.7 ft)	5 cm (2 in) AC CTB	Min. bearing capacity required
Germany	JPCP 20-30 cm (7.9-11.8 in)	5 m (16.4 ft)	CTB/LCB (bonded)	Granular blanket 30-90 cm (11.8-35.4 in)
Netherlands	JPCP 26-28 cm (10.2-11 in)	3.5 - 5 m (11.5-16.4 ft)	LCB	Sand layer
Belgium	CRCP 20 cm (7.9 in)	---	LCB	20 cm (7.9 in) minimum granular
	JPCP 23 cm (9 in)	5 - 6 m (16.4-19.7 ft)	LCB	20 cm (7.9 in) minimum granular

\* All joints dowelled, 26 mm (1 in) diameter typical

\*\* LCB = lean concrete base, AC = asphalt concrete, CTB = cement-treated base



• **Catalog of Designs**

Most countries have developed a catalog of pavement designs for asphalt and concrete pavements. These designs appear to be based upon both theoretical analyses and practical experience from a team of experts. They are based on data unique to a given country or region. A design catalog is helpful in communicating the appropriate design to administrators and to the field.

Especially for concrete pavement, having the details of the cross section clearly defined may help avoid construction problems. In addition, project designers do not need to understand all of the theory involved to design a pavement when using a catalog. Germany has a catalog for both new pavement design and another catalog for rehabilitation design, part of which is shown in Figure 2.1.

JPCP overlay on interlayer of lean concrete or AC on fractured old pavement.

Traffic	SV	I	II	III
Class				
JPCP overlay	26	24	22	22
Interlayer	≥10			
Fractured old slab				
Subbase				

JPCP overlay on geotextile on fractured old pavement.

Traffic	SV	I	II	III
Class				
JPCP overlay	27	25	23	23
Geotextile				
Fractured old slab				
Subbase				

JPCP full-depth reconstruction with untreated, open-graded permeable base.

Traffic	SV	I	II	III
Class				
JPCP	120*	120*	120*	120*
Open-graded permeable base	30	28	26	26
	45*	45*	45*	45*

\* Moduli in MPa (1 MPa = 145 psi), thicknesses in cm (1 cm = 0.3937 in)

Figure 2.1 Portion of the German design catalog for rehabilitation alternatives. (Note that many other factors are specified such as minimum foundation bearing capacity, concrete strength, drainage, joint design, etc. See cross-sections shown in Figures 2.4 and 2.10).

- **Thick Granular Layer Over Subgrade (Beneath LCB or CTB)**

Nearly all countries provide a thick granular layer (20 to 90 cm (8 to 35 in)) between the subgrade and the treated base course to control frost heave and increase support to a minimum specified bearing design level. Note in Figure 2.1 the minimum modulus of elasticity that must be met at the top of the subgrade (45 MPa (6,500 psi)) and at the top of the granular layer (120 MPa (17,400 psi)). This plate load test (German standard test DIN 18134, June 1990) involves a circular plate loaded in several stages. In each load stage there is a wait until the change in settlement does not exceed a specified value. The minimum modulus of elasticity required results in a relatively stiff foundation upon which the treated base course (i.e., lean concrete) and concrete slab are supported.

- **Long Design Lives**

Many of the countries structurally design concrete pavement for long design lives of 30 to 40 years. This long design life may be in part responsible for the excellent performance of concrete pavements in Europe.

- **Heavy Truck Traffic**

This situation currently exists in Europe and the expectations in every country visited are that traffic will continue to increase in volume and weight even more rapidly with the economic growth that the EC will bring. Some countries will be

increasing their legal axle weights to match the EC standard of 11.5 t single axle (25,300 pounds), while others exceed this already. A summary of legal axle loads which shows the large differences from the USA load limits is provided in Section 1. Most trucks in Europe observed by the Study Tour had super-single tires.

France provides one example of growth in heavy truck traffic. France has had large increases in its volume of trucks and expects an 8 percent annual growth in trucks. Truck volumes on the outer lane of urban freeways range from about 2,000 to 10,500 per day. Legal axle loads are among the highest in the world: 13 t (28,600 pounds) for single axles and 21 t (46,300 pounds) for tandem axles.

- **Life-Cycle Cost Analysis**

Some countries such as France conduct life-cycle cost analyses of pavement alternatives over a 25- to 40-year design period using a discount rate, no user costs and a new surfacing at specified times. Other countries include only the construction cost in the economic analysis. The French philosophy is expressed by the following remarks:

"The pavement structures given in the catalogue of standard designs are equivalent and offer the same service life. However, the amount of maintenance needed to prevent premature aging of the structures and to guarantee satisfactory surface characteristics differs. One of the

advantages of concrete pavements is that they require very little maintenance. This is why an economic comparison of pavement structures must also look at the global investment cost including maintenance."

- **Full-Width Paving for Future Traffic Control**

Several countries such as Germany, the Netherlands, and Austria build their standard two-lane, one-direction freeways with the full-depth concrete slab wide enough (11 m (36 ft), 11 m (36 ft), and 11.5 m (38 ft) in those three countries respectively) to be capable of handling four lanes of traffic for any future emergency (such as a landslide)

or planned rehabilitation. This makes it possible to completely close the opposite direction for rehabilitation. Shoulders are called "emergency lanes" in Europe for this reason.

- **Widened Truck Lanes**

This has been a widely used concrete pavement design in most European countries for many years to reduce edge and corner loadings. The Study Tour observed many pavements with a widened truck lane during the trip. The edge stripe is placed at its normal lane width position. Some countries also include tied concrete shoulders, as shown in Figure 2.2.



Figure 2.2 Typical widened traffic lane (4.25 m (13.9 ft)) with paint stripe placed 0.5 m (1.6 ft) from edge of pavement.

- Trapezoidal Cross-Section

This interesting design concept has been used in several countries, most notably France and Spain. The purpose of this design is to provide the thickest slab in the most critical area of loading (the outer edge of the pavement) while minimizing the amount of concrete used. The French use a trapezoidal cross-section on new pavements as well as reconstructed lanes. In the French trapezoidal cross-section, as shown in Figure 2.3, the slab thickness varies from 26 to 29 cm (10 to 11.5 in) across a 7-m slab (23-ft) (two lanes).

- 3-D Finite Element Use in Design.

The French developed and use a three-dimensional finite element analysis program called CESAR to assist them in developing their concrete pavement designs.

- Unique German Concrete Pavement Design

This pavement design impressed the Study Tour by its proven history of excellent performance and for conceptual reasons. It is shown in Figure 2.4 and has several unique characteristics listed.

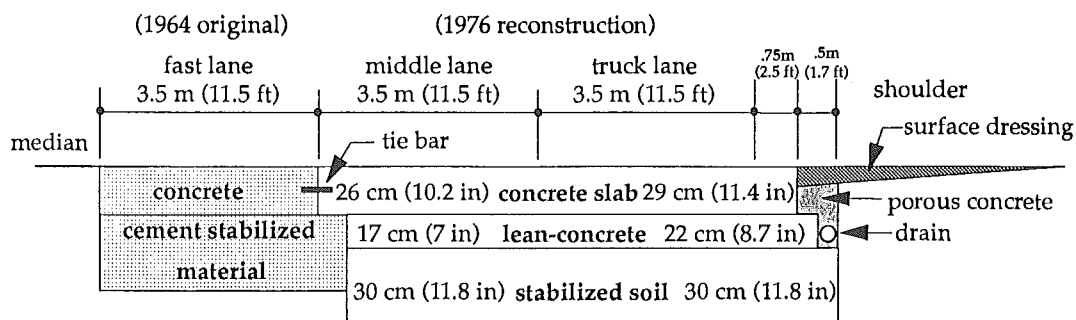
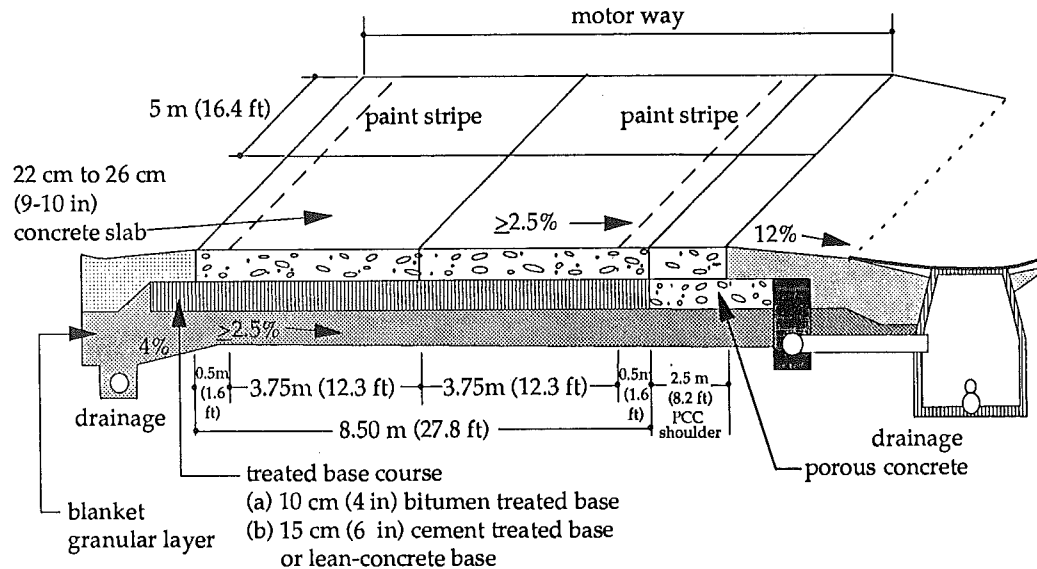

Figure 2.3 Example French trapezoidal cross-section design for reconstructed traffic lanes.

- Unique JPCP and CRCP Pavement Design from Belgium and Austria

Placement of an AC layer between a PCC slab and a base (lean concrete, cement treated, or untreated granular)

is required in some countries, including Belgium and Austria. The AC layer provides a bond between the slab and the base and reduces erosion. Some sections in Belgium where the AC layer was eliminated have resulted in erosion and punchouts in CRCP.



- Jointed plain concrete pavement.
- Slab thickness depends on traffic.
- Usually two-layer construction with slab containing high-quality crushed aggregates.
- Widened traffic (both passing and truck) lanes.
- Full-width paving thickness for future traffic control during rehabilitation.
- Shoulder is tied concrete.
- Concrete strength is similar to USA.
- Base is cement treated or lean concrete.
- Base is bonded to slab, reflection cracking is avoided by providing joints (or notches) in the base just beneath joints in slab.
- Subbase consists of a thick granular blanket.
- Transverse joint spacing is relatively short.
- Doweled joints, unevenly spaced, plastic-coated dowels, automatic dowel placement.
- Transverse and longitudinal joint sealant is neoprene compression seal.
- Longitudinal joint saw depth is 0.40 - 0.45 of slab thickness.
- Subdrainage with a porous concrete layer beneath the outer shoulder plus circular pipes connected to a closed drainage system. The underlying granular blanket provides some bottom drainage.
- Surface texture currently used is a light longitudinal brush (burlap drag) to produce a low-noise surface. The hard high-quality aggregates used in the top layer provide adequate friction. The uniform cross-slope required is 2.5 percent.

Figure 2.4 German jointed plain concrete pavement design.

- **No Crown, Straight Cross-Section**

Most countries have a straight 2.5 percent cross-slope across all traffic lanes and shoulders to promote rapid drainage and smoother pavements.

- **Notched and Bonded Lean Concrete or Cement-Treated Base**

Germany bonds a lean concrete base or CTB to the slab with good success without the risk of reflection cracks.

This is accomplished by notching the base immediately after placement exactly beneath the transverse and longitudinal joints of the concrete slab. The bond lasts at least 10 years and provides a monolithic slab which reduces curling stresses and erosion at the interface, which often occurs when the layers are debonded (See Figure 2.5).

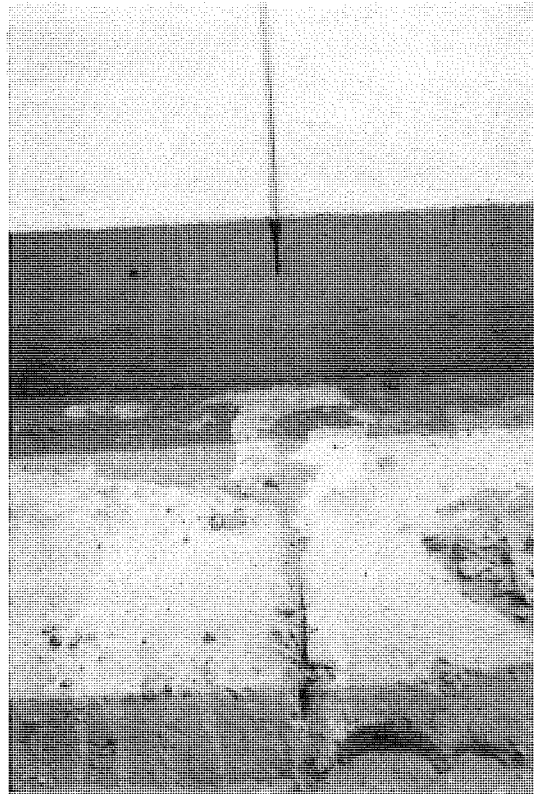

Figure 2.5 German JPCP slab on lean concrete base that has been notched or jointed. (Note: all joints along project showed an initial crack like this joint after a few days curing.)

- **Longitudinal Edge Drains Connected to Closed Drainage System**

The German cross-section (Figure 2.4) shows a porous concrete layer beneath the shoulder that provides a flow channel to a longitudinal subdrain. This empties at regular intervals into a lateral pipe and finally into a larger longitudinal closed drainage system.

- **Ditch Line One Meter (Three Feet) from Bottom of Base**

The Netherlands requires this to help drain the cross-section. Pavements in other countries also appeared to have deep ditch lines.

- **Geotextile Drainage Fabric Between Slab and Base**

This is specified in Germany to be placed between a new JPCP overlay and old fractured concrete slab. In France, the Study Tour observed a thick fabric placed beneath the slab on top of a granular base.

- **Porous Concrete Base Under Shoulder**

A porous concrete base about 15 cm (6 in) thick is specified in Germany's cross-section under the outer concrete shoulder to facilitate base drainage, as shown in Figure 2.4. This is also used in France and Italy to drain the cross-section. The porous layer is connected into a drainage system in all cases.

- **Reinforcement in CRCP**

Some unique and interesting reinforcement designs were found in Europe:

✓ **Rectangular flat steel high-strength strips (FLEXARM):** A coilable reinforcement was developed in France (Figure 2.6) to shorten the length of the construction train, reduce the complexity of bar reinforcement placement, reduce the labor involved and make the reinforcement easier to transport. This reinforcement has been used in France since 1988 for several major freeway projects under the commercial name of FLEXARM. This carbon steel has a high yield strength of 790 MPa (114,550 psi), a flat rectangular section (4 cm (1.6 in) wide and 2 mm (0.08 in) thick), a corrugated surface which is corrosion-protected by continuous hot galvanization, is supplied in coils and is joined in the field by rapid pneumatic riveting.

✓ **Using an increased steel percentage has shown excellent performance in Europe:** Belgium used 0.85 percent from 1970 to 1978 and obtained excellent long-term performance on over 100 km (62 miles) of heavily trafficked freeway with no punchouts. Projects in France and Spain with 0.72 to 0.85 percent steel have shown excellent performance also.

✓ **Placing the steel above mid-depth:** A depth of approximately one third of the slab thickness holds cracks tighter and results in better performance according to experienced engineers from Belgium and France.

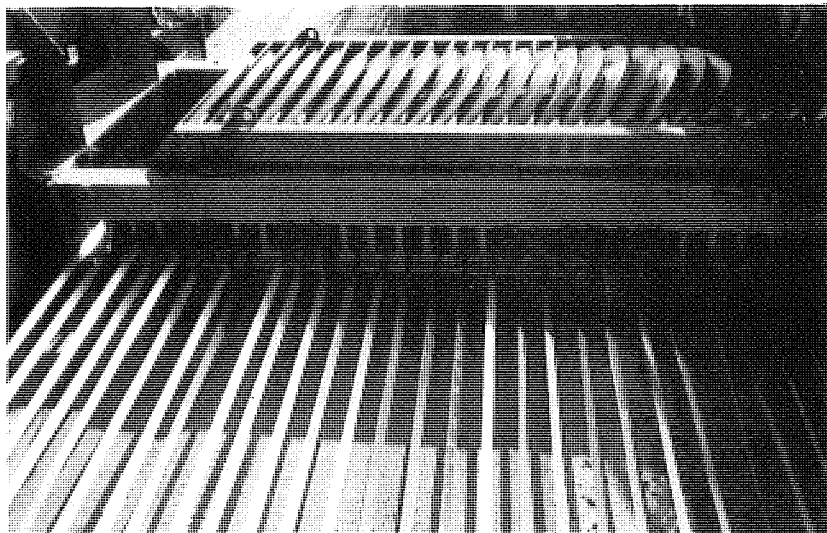

Figure 2.6 Coilable rectangular reinforcement (FLEXARM) developed in France.  
(Note: coils held in diagonal position at top of photo.)

✓ **Skewed transverse steel:** Used in Belgium to prevent any transverse cracks from forming over transverse steel.

- **CRCP with Porous Asphalt and Concrete Surfacing**

CRCP is surfaced in the Netherlands, France and Italy with porous asphalt. Porous concrete has also been used in Netherlands and France. This design has some strong advantages and disadvantages, as described in the section on surfacings.

- **Dowels Required to Control Faulting**

Based upon experience in many countries, the overall conclusion is that dowels are required to control faulting in transverse joints for JPCP for heavily trafficked highways in Europe. This was strongly stated, based upon field experience, in Belgium, Germany, Netherlands, Austria and Spain. This conclusion was painfully learned in several countries that adopted the typical original "California" design for JPCP with no dowels, an erodible base and no subdrainage. This led to pumping, faulting, and slab cracking.



- **Varying Dowel Placement Across Traffic Lanes**

Nearly all countries vary the dowel placement across the traffic lanes and emergency lanes (shoulders) to economically place adequate load transfer devices at the locations where the greatest number of heavy wheel loads pass. Automatic dowel placement equipment can place nonuniform dowel patterns. An illustration of dowel spacing in Germany is given in Figure 2.7.

- **Plastic-Coated Dowels and Deformed Tie Bars**

Germany uses 25-mm-diameter (1 in) dowels with a plastic coating at least 0.3 mm (0.01 in) thick covering the total length of dowels and no oil used

at construction. They are placed with automatic dowel inserters. The apparent quality of the coating was impressive.

- **Short Transverse Joint Spacing**

Joint spacing in JPCP is critical to minimize transverse cracks due to curling and warping. European countries have clearly recognized this for many years and joint spacing in most of these countries ranges from 4.5 to 6 m (15 to 20 ft), with 5 m (16.5 ft) being the most popular. Since most joints are doweled, the transverse joints are perpendicular to the centerline. Slab thicknesses range from 22 to 28 cm (9 to 10 in) for these joint spacings. A 5-m (16.5-ft) joint spacing was also used at the new Munich II airport for slab thicknesses up to 40 cm (16 in).

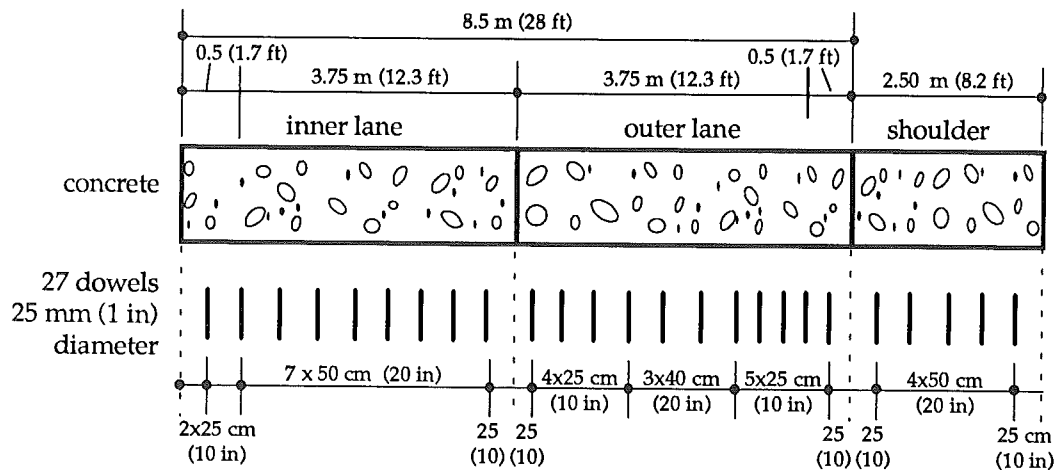

Figure 2.7 Varying dowel bar spacing across pavement in Germany. (See Figure 2.4.)

- **Sealing of Joints**

European countries differ as to whether or not they seal joints and as to what type of seal they use. Most countries seal transverse and longitudinal joints. An exception to this is Austria, where in some areas a narrow (3 mm (0.1 in) wide) joint is saw cut and not sealed, which reduces construction cost by about 10 percent. Spain seals transverse joints in wet areas but not in dry areas. Longitudinal joints are sealed in all areas in Spain.

- **Two-Layer Construction Concept**

This concept is used in several countries in Europe for economic and safety reasons. Equipment is available to slipform two layers in one pass as described below.

- ✓ **Two-layer construction has been used extensively in Germany since the 1930's on highway and airport pavements. This provides an economical design, with the top layer containing hard, high-quality, smaller-sized, high-friction aggregates and the lower layer containing lower-cost, locally available gravel aggregates (which must be thermally stable). The top surface is more resistant to freeze-thaw damage, has a lower noise level due to the smaller aggregates, and has improved friction.**

- ✓ **Two-layer construction is used currently in Austria to provide a top layer with hard and durable smaller-sized aggregate (8 mm (0.3 in) maximum). An exposed aggregate surface is then created to provide a**

low-noise, high-friction surface. High-quality aggregates are expensive and cannot be used throughout the full slab thickness. Figure 2.8 shows a photo of a two-layer slab from Austria.

- ✓ **Two-layer construction is used in France with hard aggregates in the surface layer to provide an exposed aggregate surface. These aggregates are very expensive compared to soft limestones used for the lower layer.**

- **Pavement Placed Right Over Bridges**

Some countries such as Belgium and France design some bridges for the extra dead load of the pavement which is placed right over the bridge deck. This avoids end movement problems.

- **Concrete Pavement Bicycle Paths and Local Traffic**

The Netherlands constructs many undowelled JPCP bike paths. These are also used by local farm equipment.

- **Prestressed Concrete Pavements**

This pavement type has been constructed by several countries in Europe, mostly at airports. Prestressed pavements have been used extensively at Schiphol Airport (Amsterdam) for 25 years and have provided low-maintenance long lives under heavy traffic. The first prestressed pavement in the world was built in Portugal at a NATO airfield in 1965.



Figure 2.8 Two-layer construction in Austria (high-quality smaller-sized aggregates in top layer, lower-cost locally available aggregates in lower layer).

- **Concrete Block Pavers**

This has been used to some extent in most European countries for local streets and other purposes. For example, they are used extensively in the Netherlands for a wide range of applications from domestic pavements to complicated industrial pavements.

- **Reduced Electrical Energy**

In Switzerland, lighting concrete pavements consumes about 20 percent less electrical energy than lighting asphalt pavements due to the lighter-colored surface.

### Construction

Some interesting contracting arrangements are going on in highway design and construction in Europe. For example, Germany paid eight firms 150,000 DM each to develop proposals on a 30-km (18.6-mi) highway reconstruction project. The low bid was 105 million DM, which was low enough to cover all of the money spent to develop the innovative proposals.

- **Warranties for Construction**

Most highway work in Europe requires warranties for highway construction and materials.

A few examples: Germany has a four-year warranty for concrete and asphalt pavements, and French contractors must warrant AC pavement for four to five years and concrete pavement for seven to nine years. The Freyssinet load transfer devices carry a five-year warranty.

While some sources claim that warranties contribute to the high quality of pavements in Europe, more evidence is needed to support this conclusion. Beyond qualitative evidence, cultural differences between contractor and owner on the two continents must be investigated. The interrelationships of workmanship, ability to pay, construction or design choices allowed, size of company, etc., lead us to believe that the word "warranty" may mean different things to Europeans than to Americans.

A primary reason for the achievement of quality highways in Europe is a longer original design life and a European mindset for-long term use of not only highways but also homes, cars and all other products. Europe is not a disposable-driven economy. Designs include a large safety factor. For example, concrete actual strengths regularly exceed by a considerable amount design strengths, and design strengths were considerably higher than ours. USA construction contracts and quality control programs are focused on uniformity and building as close as possible to specified requirements, whereas their designs and contracts are focused on getting the best, longest-life product possible. The European designs and

specifications achieve and exceed desired results with minimum risk.

- **Two-layer Paving Equipment**

This construction procedure is extensively used in Germany, France and Austria. For example, equipment used at the new Munich II Airport paved, in one pass, a 14-cm (5.5-in) granite aggregate top course and a 22-cm (9 in) lower course made of local round gravel, forming an economical 36-cm (14-in) monolithic structure. Dowel and tie bars were placed between these layers. A "double decker" slipform paver is available that can place two separate layers "wet on wet" to form a monolithic structure. The two layers are completely different concrete mixtures.

- **Workability Meter**

This is used in France to control workability of concrete. It consists of a box with a swinging door that opens up and lets concrete flow out depending on its flowability.

- **Lower Productivity Rates and Higher Costs**

Typical construction costs in Europe appear to be about double those of the USA. Of this higher cost, about 50 percent appears attributable to higher structural design standards and the balance to lower productivity from both an equipment and labor standpoint.

- **Short Construction Duration**

Several examples of relatively fast-track construction exist in Europe. A 17-km (10.6-mi) project (11.25-m (37-ft) width), which included crushing and recycling the concrete pavement, was completed in 26 weeks in Austria. The Basel airport runway was reconstructed with only one week of actual closure and two weeks of replacing concrete slabs at night and opening at 5 AM. Early openings of slab replacements within 24 hours were reported in Vienna.

- **Uncrowned Pavement Cross-Slope Improves Ride**

Nearly all European countries are using an uncrowned straight cross-slope. This is believed to provide improved rideability.

- **Liquidated Damages = Incentives Rate / Day**

A project on the A1 freeway in Austria has a specified maximum construction period with provisions that the damage rate per day is equal to the bonus rate per day. The contractor felt that this was fair and provided considerable incentive.

- **Re-bar Tubes Behind Vibrators for CRCP for CRCP**

This procedure illustrated in Figure 2.9 provided an accurate final position of the reinforcement for a French project. They believe they are able to meet a specification of  $\pm 1.5$  cm (0.6 in) by putting the tube at the end of the liquid phase of the concrete.

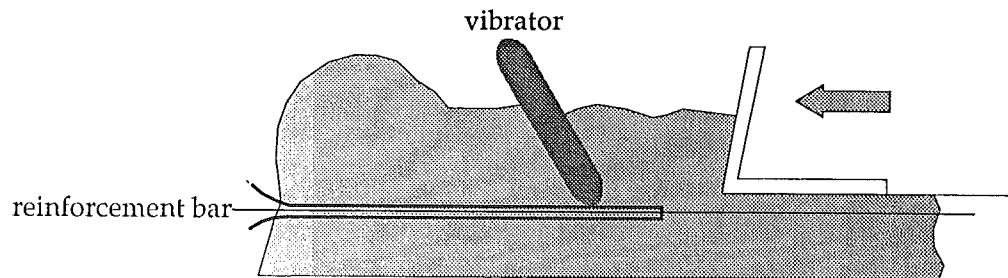

Figure 2.9 Position of tubes and vibrators used in France to place CRCP to improve position of reinforcement.

- **Prevention of Sawing Residue from Entering Joint**

Germany and the Netherlands use a long elastic band to plug the first deep saw cut to keep residue from the second joint sealant reservoir cutting from infiltrating the crack. This is considered important to keep incompressibles out of the joint prior to sealing.

- **Lean Concrete Temporary Widening for Traffic Control**

This was used on the A10 autobahn near Berlin to widen old concrete pavement to carry 4 lanes of traffic over an 8-month period. The 22-cm (9-in) lean concrete will be recycled along with the old concrete after the other side of the highway is reconstructed.

- **Concrete Mixing**

The concrete plants observed were compulsory mixing plants, and in France, continuous mixing plants. No tilting drum mixers were seen, which is virtually the only kind of mixer used in the USA. Drum mixers are common but discharge by pulling apart rather than tilting. Europeans felt that their central mix plants produced higher-quality concrete. Further investigation is needed to find out whether or not this belief is justified.

- **Vibration**

Two slipform pavers observed were equipped with "T"-shaped vibrators. The USA needs to investigate this type of vibrator to determine its merits.

## Maintenance and Rehabilitation

- **Extensive Recycling of PCC and Other Materials**

Recycling of concrete is performed all over Europe. Belgium recycles PCC into LCB. Germany recycles concrete into LCB and the granular blanket. Netherlands includes recycled rubble in LCB. Austria recycles old PCC into new PCC and believes that crushed concrete provides coarse aggregate of very good quality. To achieve low cost, Austria permits some existing AC overlay to be used in the recycled concrete. France has conducted several successful recycling projects since 1976 using crushed concrete in new concrete and in the lean concrete base.

- **Unbonded CRCP and JPCP Overlays (Some on Fractured JPCP)**

CRCP and jointed fiber-reinforced unbonded overlays of concrete and asphalt pavements are used often in Belgium with good success. In Germany, the existing concrete pavement is fractured into pieces and a 10-cm (4-in) interlayer of either notched lean concrete or AC material is placed on top of the existing concrete pavement. A JPCP overlay is then placed with the same thickness as is used for new design. Another German option is to place a 6-mm-thick (0.2 in) geotextile between the fractured old concrete pavement and a slightly thicker JPCP overlay.

Austria has placed a JPCP unbonded overlay over a thin AC separation layer on top of fractured slab. France has placed a lot of CRCP overlays over old fractured JPCP. Typical design includes the following features: 18-cm (7-in) CRCP with 0.67 percent steel and 18-cm (7-in) lean plain concrete shoulders with transverse joints at 6 m (20 ft) placed on the fractured JPCP. A longitudinal drain is placed along the edge. The transverse cracks in the CRCP were tight and the pavement was in excellent condition. This CRCP overlay is typical of several observed.

Spain has used roller-compacted concrete (RCC) for overlays of

pavements. An AC overlay is placed on top of the RCC to provide good rideability. Spain favors RCC for overlays because it can be opened to traffic very quickly.

- **German Lane Reconstruction**

The existing deteriorated traffic lane is completely removed and a new JPCP is constructed over a porous concrete base layer about 40 cm (16 in) thick. The new 26-cm (10.5-in) JPCP is placed directly on the porous concrete layer. The new lane is tied securely to the old traffic lane with deformed reinforcing bars. This cross-section is shown in Figure 2.10.

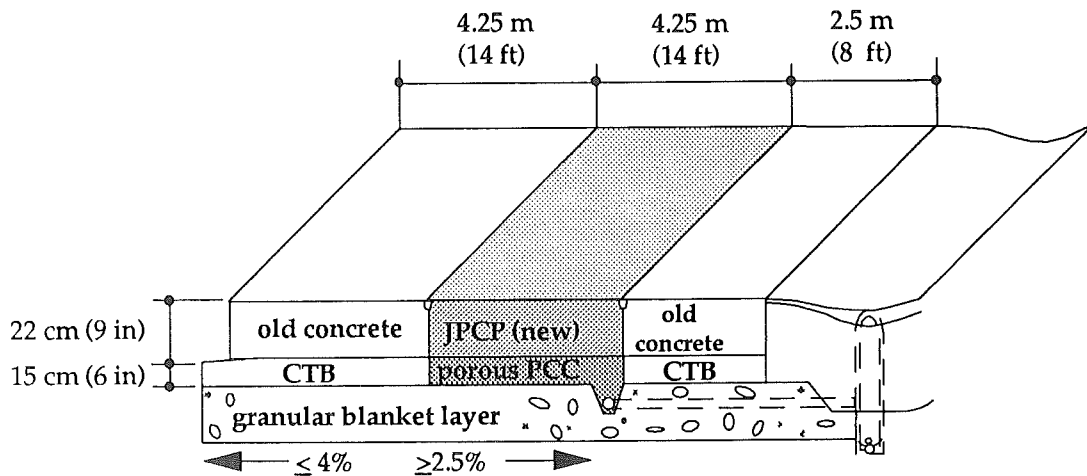

Figure 2.10 German cross-section for lane reconstruction with porous concrete base.

- **German Total Width Reconstruction**

In general, it appeared that Europeans tended to reconstruct or resurface rather than restore concrete pavement. All of the existing pavement is removed and a JPCP is placed on an untreated permeable base course. This base type is new for Germany; however, this technique makes it possible to use up to 100 percent recycled material from the old pavement. Slab thickness is increased for this option over that used for the normal lean concrete base.

- **French Lane Reconstruction**

Trapezoidal cross-sections have been used on many freeway reconstructions of one or two lanes. Typical thickness is 26 cm (10.5 in) at the inside edge to 29 cm (11.5 in) at the outside edge across two lanes, a 0.75-m (2.5 ft) widened traffic lane, a lean concrete

base, and a cement-stabilized soil, as shown in Figure 2.3. Longitudinal subdrainage along the edge is used. This design carried more than three times the truck loadings than the original traffic lane having the conventional "California" design.

- **CRCP Widening on AC Pavement for Added Truck Lane**

Several major projects in France have been completed where either the outer AC traffic lane was removed and replaced with CRCP or a lane was added by removal of the shoulder and replacement with CRCP. A large proportion of trucks use this outer lane and due to the previous major deterioration in this traffic lane it is believed that the future will require a very heavy structural design. One project observed by the Study Tour had a 31.5-cm (12.5-in) CRCP slab, as shown in Figure 2.11.



Figure 2.11 CRCP truck lane addition to original AC pavement in France.



- **Automatic Faulting Measurements**

Faulting measurements taken directly from the APL profile were shown to the Study Tour. The extent of transverse joint faulting was readily observable and measurable.

- **LCPC/Freyssinet Load Transfer Devices**

The French LCPC laboratories and Freyssinet International have developed a device to restore high load transfer in the transverse joints of

undowelled JPCP. These undowelled joints exhibit poor load transfer that leads to faulting and slab cracking of the original slab, plus deterioration of reflection cracks of an AC overlay. These devices have been placed on many sections of JPCP in France with good success in restoring load transfer from less than 50 percent to over 90 percent. They have been successfully used prior to placement of a porous asphalt surface to reduce reflection cracking. A Freyssinet load transfer joint or crack is shown in Figure 2.12. The device carries a warranty.



Figure 2.12 LCPC/Freyssinet French load transfer device.

- **Rehabilitation Programmed when Pavement Condition is "Good"**

It appeared to the Study Tour that far less pavement deterioration is allowed in European pavements before rehabilitation is done than in the USA. This was especially true for toll roads. The Study Tour was very impressed with the extent to which the toll road companies are vitally concerned with providing the highest-quality service to users and are constantly seeking to improve service levels.

- **Fiberized PCC Overlay of AC Pavement**

Used successfully in Belgium for several projects. One project observed by the Study Tour had a 12-cm (5-in) steel fiber-reinforced concrete overlay placed over a badly rutted AC pavement. A 10-m (33-ft) undowelled joint spacing was used; however, curl is considerable. The existing 22-cm (9-in) AC pavement was milled 12 cm (5 in) prior to placement of the 12-cm (5-in) fiberized concrete overlay. The pavement was in excellent condition after four years. A 5-m (16.5-ft) joint spacing has been built and worked well. Belgium has constructed over 130,000 square meters (142,200 square yards) of this type of overlay on concrete and asphalt pavements.

- **JPCP Overlays of AC Pavements**

Several have been built in France starting in the 1970's. They have shown very good performance over many years. Their typical slab thickness was 21 to 25 cm (8.5 to 10 in), 4.5-m (14-ft) undowelled joint spacing with 600 to 1000 trucks per day in one

lane. The new JPCP overlay is placed directly onto the old pavement, or onto a leveling course of lean concrete.

- **Performance of Overbanding of Longitudinal Lane/Shoulder Joint Seal Performance**

The French used polymerized SBS asphalt hot-poured joint sealant in an overbanding configuration between the concrete traffic lane and the AC shoulder. This sealant was observed to have performed very well in the 6 years since construction.

- **Thin Polymerized AC Layer for Studded Tire Wear in Austria**

Studded tires caused considerable damage to older Austrian pavements, resulting in ruts of 2 to 3 cm (0.9 to 1.2 in). Since Austria has a lot of rain, some type of rehabilitation had to be performed. A thin polymerized asphalt layer has been placed over the truck lanes of many older concrete pavements to fill in the studded tire damage. This layer has a life of only four to six years.

- **French Pavement Evaluation**

French research has developed several types of pavement monitoring equipment. The latest equipment development is called the SIRANO which measures profile, takes continuous 35-mm film for a lane width and determines macro-texture at a speed of 72 km/hr (45 mi/hr). The SIRANO successfully tested 5,500 km (3,415 mi) in 1991.

The French also conduct a comprehensive evaluation to determine

the need for and design of pavement rehabilitation. A policy of prevention is encouraged, in which a rehabilitation action is taken as soon as fatigue cracking has initiated (i.e., before more serious structural deterioration of the slab and base occurs).

### Concrete Materials

- **Highly Durable Concrete Slabs**

The Study Tour traveled extensively on the European freeway system and did not observe any concrete durability problems. Discussions with engineers in each country revealed that very few durability problems exist. Some examples that provide some possible reasons for this are provided.

✓ 1930's German autobahns show no durability problems after more than 50 years. This old concrete had the following characteristics: lower traffic during its early life, a relatively mild climate, care in proportioning uniform gradation mixes, 3-cm (1.2 in) maximum size, high-quality, hard aggregate in the top course, consolidation by vibration, a dry concrete mix (water-cement ratio less than 0.35), 21-day water curing, protection of concrete from sun and wind with 21-day tent cover, no deicing salts used for many years, and a thick granular layer between the slab and the subgrade (except in areas where a sand subgrade was present) that provided some bottom drainage. A photo of a 1939 concrete pavement on the German autobahn is shown in Figure 2.13.

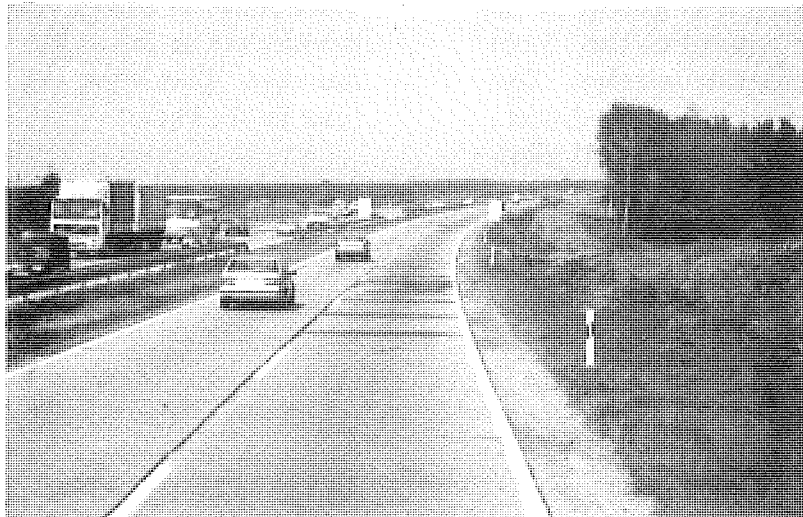

Figure 2.13 Photo of original 1939 concrete pavement on the German autobahn approaching Berlin from Munich.

✓ Germany has a quality testing program to achieve durable aggregates, correct gradation of aggregates, and a good air void system. The air void system is determined during construction using the Danish meter for fresh concrete to determine the air void content and void system. Tests are conducted the first day of production and again if there is any doubt as to air void system. The tent cover for a two-hour minimum (7 days at the Munich II Airport project) provides surface protection for early curing.

✓ Swiss quality control program for concrete durability. The measurement of the total content of air voids of the fresh concrete was not sufficient for the evaluation of frost and chloride durability in Switzerland. Only an appropriate testing method applied to the hardened concrete can give pertinent information. Rapid and practical procedures were developed to examine the hardened concrete. The microscopic control of concrete is carried out on thin sections made from a concrete core specimen impregnated with a special fluorescent dye and examined under the microscope in transmitted ultraviolet light.

Laboratory tests are conducted a few months before the project begins. Aggregates are submitted to quality tests. Several concrete mixes are prepared at the laboratory to work out a mix design of high durability with a good air void system (size, quantity and distribution in the cement paste are measured).

Trial run tests take place two to three weeks before construction to evaluate the batching, mixing plant, and placement equipment to test the suitability of the mix design from the laboratory under in situ conditions. The concrete is mixed, hauled and placed in two or three trial slabs. Several test cores are obtained and tested, and the results are compared to those obtained in the laboratory. Any needed adjustments to the mix or construction process are made.

During the first few days of construction, cores are taken from the pavement and tested. A microscopic analysis is again conducted to ensure that the hardened concrete maintains the proper air void system. These results are available within 36 hours after the concrete is placed. If the air void system is inadequate, a rapid-cycle freeze-thaw test is conducted on one of the cores (Dobrolubov-Romer). If the air void system is inadequate, the surface of the concrete is impregnated with an agent. These quality control procedures have led to the elimination of frost-salt durability problems in concrete pavements in Switzerland.

Not many concrete pavement projects are constructed; however, when they are a comprehensive preparation is accomplished. This amount of preparation would increase our costs greatly in the USA.

✓ Austria has very durable concrete with no significant problems even in a harsh climate. Pavements built in early 1950's showed no durability problems.

✓ France requires the proportioning of aggregate to achieve minimum void content.

- **Blended Cement and Concrete Mixtures in Spain**

Spain uses concrete containing crushed limestone as the coarse aggregate, which has proven to yield low shrinkage and good flexural strength and facilitates joint sawing. The requirement that at least 30 percent of the fine aggregate be composed of siliceous particles has resulted in pavements without friction problems associated with texture wear. Concrete must attain a flexural strength at 28 days of 4.5 MPa (640 psi) from a third-point loading test. Blended cement containing flyash (blending must be done at the plant) is used in the concrete (38 percent flyash) and lean concrete base (50 percent flyash). A large cost reduction was obtained by the government for these blended cements for use in pavements! The water/cement ratio is between 0.44 and 0.50, slump is between 2 and 4 cm (0.8 and 1.6 in), and plasticizers are used in drier mixes.

- **Lean Concrete in Spain**

Lean concrete or cement-treated bases must have a minimum compressive strength of 8 MPa (1160 psi) at seven days; or alternatively not less than 12 MPa (1740 psi) at 90 days for slower-strength-gaining mixtures.

- **Steel-fiber Reinforced PCC**

Belgium has built 12 or more projects as previously described. They include 5-cm-long (2 in) steel fibers ( $30 \text{ kg/m}^3$  (50 pounds/yd<sup>3</sup>) steel) and performed well: no cracks were observed in the long slabs (10 m (33 ft) joint spacing). Shorter slabs are recommended.

- **Higher-strength Concrete in Slabs**

Some countries, particularly Belgium, use much higher-strength concrete than the USA. Belgium uses a high cement content ( $400 \text{ kg/m}^3$  (674 pounds/yd<sup>3</sup>)) which produces a strong, dense concrete having a minimum compressive strength of 55 MPa (7975 psi) and a mean strength of about 70 MPa (10,150 psi) at 90 days. No freeze-thaw or any other durability problems exist. The high cement content helps reduce surface wear also. Austria has 28-day flexural strengths ranging from 6.5 to 9.5 MPa (942 to 1378 psi) with mean of 7.5 MPa (1087 psi) and Italy has a mean 28-day flexural strength of 8.3 MPa (1203 psi) and a mean compressive strength of 56.5 MPa (8193 psi).

- **Lean Concrete Used for Shoulders or Emergency Lane**

A French project had tied lean concrete shoulders that appeared to perform very well. This design reduced costs.

- **Thick Porous Concrete Slab**

Some countries are developing this design, such as the Netherlands and France where it is defined as a porous concrete base surfaced with a free-draining concrete layer, having a total thickness of 40 cm (16 in). These pavements substantially reduce traffic noises and act as storm runoff reservoirs in urban areas. These pavements must be maintained to prevent clogging.

- **Lower-Quality Aggregates in Concrete Slab with AC Overlay**

France uses lower-quality local aggregates in concrete pavements for which an AC overlay is also to be placed during construction. This reduces overall pavement costs in areas where only poor aggregates exist. There is little freeze-thaw cycling in these areas.

- **Recycled PCC Including Recycled Asphalt Concrete (RAP) Material**

Austria has conducted laboratory tests and several large field projects where the old concrete slabs with AC overlays have been recycled back into regular concrete for pavement. Recycled concrete pieces are being used as the coarse aggregate and the sand fraction used in cement stabilization of the existing granular subbase. The crushed concrete particles may contain up to 20 percent RAP particles without impairing the quality of the new concrete. However, only about 6 percent AC content is generally used because greater

amounts of RAP require larger amounts of cement and this becomes uneconomical. Recycling concrete with asphalt provides a more economical mixture and a way to reuse RAP overlay material.

### Surfacings

- **Emphasis on Reduction of Tire/Pavement Noise and Vibration**

Many concrete pavements were textured with transverse coarse tining that was very good for friction and hydroplaning but caused considerable road noise and vibrations. This technique is no longer used.

- **Longitudinal Light Texturing for Noise Reduction on New Pavement**

In Germany, significant noise reductions were achieved by creating a lightly rough longitudinal texture, using a burlap drag, a longitudinal smoother, and smaller top-sized aggregates. This produces a noise level about the same as that of a porous AC surface after a year. In Spain, low-noise surfacings are obtained using a combination of longitudinal brush and comb, achieving both a microtexture (with the brush) and a macrotexture (with the comb).

- **Porous AC Surface for Noise Reduction of New or Existing Pavement**

Many countries have used porous AC surfaces for old and new concrete pavements. It has some significant advantages and disadvantages. The

advantages of this design are the following: it eliminates hydroplaning, eliminates tire spray, gives good friction resistance, has low tire/pavement noise emission, gives a smooth ride, does not have reflection cracks, and waterproofs cracks in CRCP. Its limitations include a significant decline in the noise-reducing effect over time as the layer fills with materials, a relatively short life, and higher deicing salt requirements to prevent icing. Unsafe conditions can develop when icing cannot be prevented completely.

- **Porous Concrete Surface for Noise Reduction on New Pavement**

The Netherlands (see Figure 2.14) and France have constructed porous concrete surfaces on newly constructed concrete pavements that give significant reduction in noise levels. The porous concrete surface has many of the advantages and disadvantages listed for porous AC surfaces, but this technique is still under development.

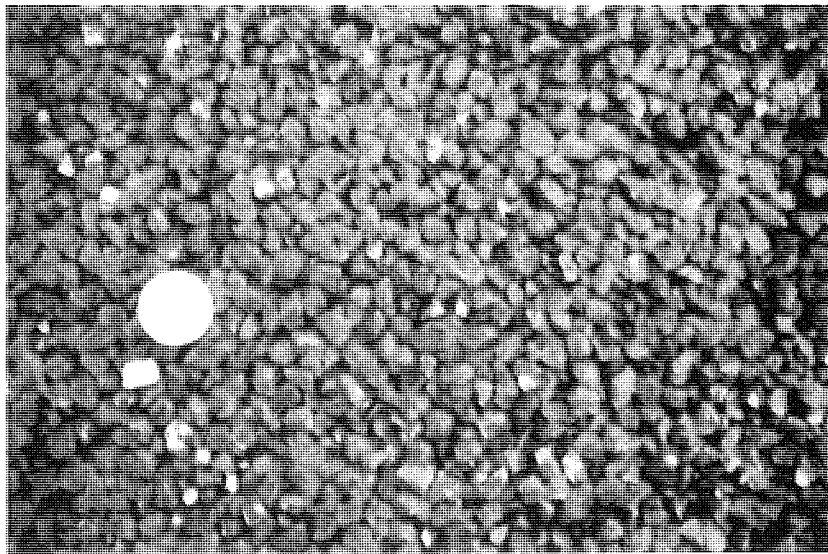

Figure 2.14 Photo of porous concrete surfacing placed on JPCP in Netherlands.

- **Exposed Aggregate Surface for Noise Reduction on New Pavement**

A surface texture with low rolling noise and low vehicle vibration but high friction is achieved through a technique for chemically exposing aggregate. This technique is used extensively in several countries, including Belgium, Austria, the Netherlands, and France. In Belgium, after the paver passes, the surface is immediately sprayed with a retarder which penetrates several millimeters into the mortar. A polyethylene sheet

is then placed over the surface. This serves to protect the retarder from the effects of inclement weather and to protect the effectiveness up to the moment when the retarded surface mortar is removed through special wire brushing after 24 to 72 hours. The aggregate at the surface is then exposed and has the desired surface texture to reduce rolling noise and vehicle vibration. The surface has about the same rolling noise characteristics as porous asphalt after one year. A photo of an exposed aggregate surface is shown in Figure 2.15.

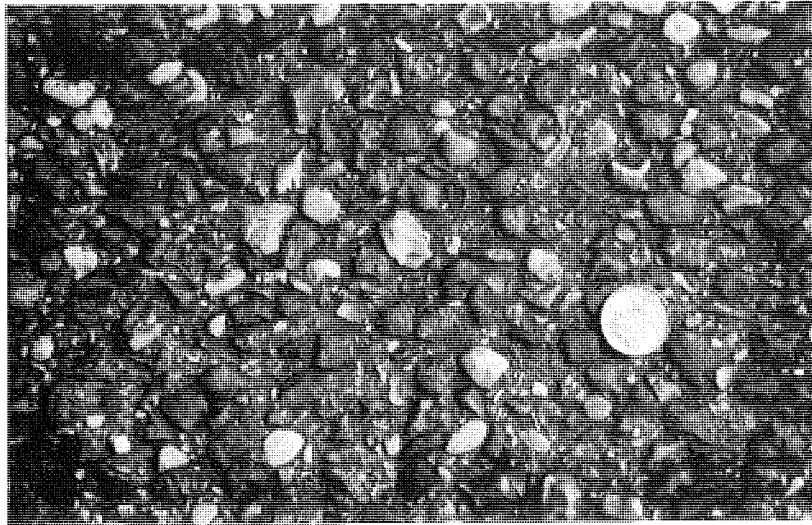

Figure 2.15 Photo of an exposed aggregate surface in France.



In Austria and France, the exposed aggregate technique is similar, however, a major difference is that in Austria the slab is placed in two layers so that the top layer can contain a high quality, smaller aggregate (maximum size 7 to 8 mm (0.27 to 0.31 in)) to maximize noise reduction. The two-layer method is used in Austria because the aggregates that are resistant to wear and polishing are expensive. The exposed aggregate surface also provides a high level of friction resistance.

- **Diamond Grinding Surface for Noise Reduction on New or Existing Pavement**

This is used very successfully in Belgium to reduce noise over the original coarse cross tining. It is also used in the Netherlands to reduce noise over original transverse brush texture.

- **Surface Layer of Epoxy/Aggregate for Noise Reduction on Existing Pavement**

The Netherlands uses an epoxy resin binder applied to a hardened concrete surface, followed by a layer of crushed 3- to 4-mm (0.12- to 0.15-in) chromium ore slag (brand name Durop) and surface rolling to produce a mosaic-like structure. The Durop surface treatment achieves large noise reduction relative to the original brushed concrete surface. This treatment is comparable to porous asphalt.

- **French Double Surface Treatment for Existing Pavement**

A thin surface called a double layer is placed to improve the rideability of existing pavements. The surface treatment consists of a spray of polymerized asphalt on the concrete surface, a layer of 1.4-cm (0.55 in) chips, and then a layer of 1-cm (0.4-in) chips placed with no compaction.

- **Overall Evaluation of Surfacing**

Figure 2.16 shows a plot of noise emission versus vehicle speed for old concrete surface (cross-tined), burlap drag, and exposed aggregate as measured in Austria. These and other data show that old concrete has the highest noise emission level, and the other treatments including porous asphalt, exposed aggregate and epoxy/fine aggregate surface dressing are very similar.

### Research and Development

The Study Tour was very impressed with the pavement research programs underway in most of the countries visited. Particularly impressive also was the very close working relationships that existed between public and private agencies.

- **Close Government and Industry Relationships**

✓ In Belgium, close cooperation exists between government and industry. The development of the exposed aggregate surface is an example.

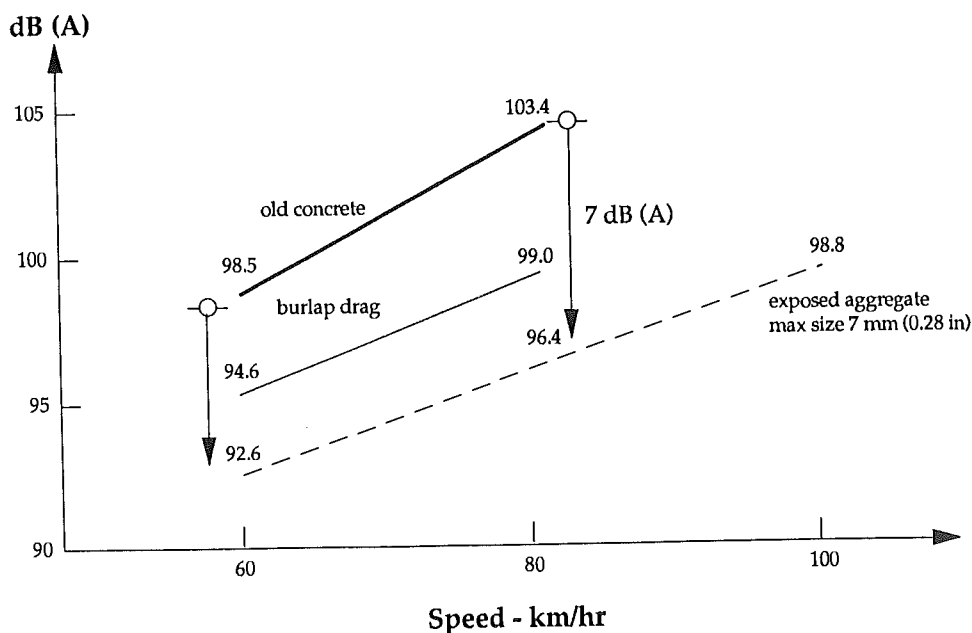

Figure 2.16 Measured noise emissions for various surfacings in Austria.

✓ In Germany, Austria and the Netherlands, close cooperation exists between public and private organizations.

✓ The French national research study on concrete pavements appears to be an ideal example of the close cooperation between public and private organizations. Private organizations add funding to some of these studies that they consider very important. The great benefit of this appears to be considerable innovation and results that actually get used on the French highway system because all concerned were involved in its development.

- Accelerated Field Testing of Concrete Pavements

The French LCPC/Nantes circular test track shown in Figure 2.17 is an excellent tool for accelerated testing of

concrete pavement designs. The test track is part of the national research project in concrete pavements. The Study Tour observed the large test track in operation and saw some of the early results obtained. One million loads per month can be placed on the concrete pavements.

- Higher R & D budgets than USA

It appears that in most European countries the research effort underway was substantial. For example, the German cement institute has 4 times the budget of the USA's Portland Cement Association (PCA) and American Concrete Pavement Association (ACPA) combined.

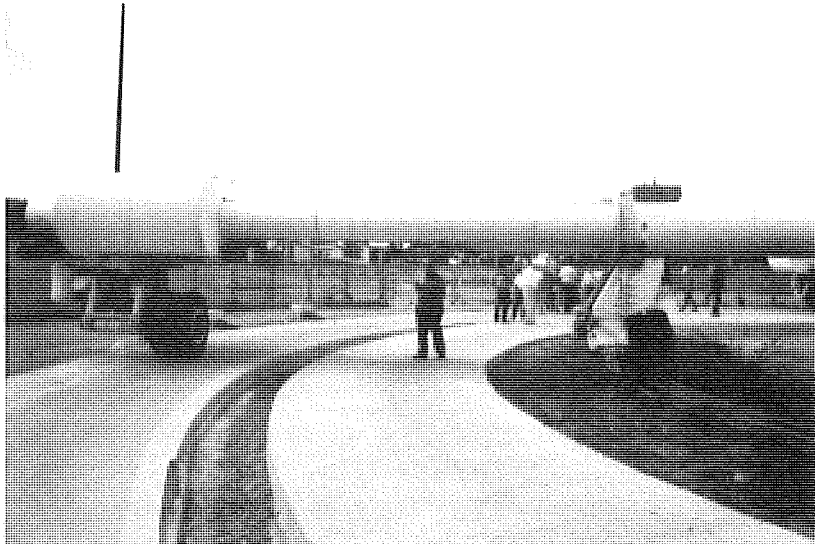

Figure 2.17 French LCPC/Nantes circular test track.

- **Willingness and Eagerness to Try New Ideas**

Europe has a very strong commitment to research and development to improve concrete pavements.

Germany has continued to improve its concrete pavement designs over many years through research studies carried out by government agencies and universities. The Netherlands is very willing to try new ideas and fully develop them until they work.

In France, tremendous energy goes into identifying and developing new and innovative ideas. One comment was that "the maintenance and growth of the competitiveness of concrete-based

road techniques depends on constant innovation, the result of a partnership between the industry and operating authorities."

- **Designated Percent of Construction for R & D**

In Belgium, 0.8 percent of all construction projects goes to support research studies.

- **A Global View: Exporting Technology by Licensing R & D Products**

The French hold this point of view very strongly. Many developments by the French national laboratory LCPC

are subsequently licensed for commercial use. Many products are jointly funded and developed.

- **Implementation of Research**

Dr. Sommer of the Austrian Cement Research Institute stated that implementation requires more effort than the original research. He believes that the researcher should guide the field implementation until the procedure is developed. This is an interesting concept which would develop a partnership between research and operations that is needed for implementation.

#### **Engineering Expertise**

Solid groups of experienced pavement engineers exist in most of the countries visited. It appears that it is the general practice for individuals to make their career in pavement engineering. The Belgium Road Research Center has an engineering group with many years of pavement engineering experience. The Technical University of Munich has a group of faculty and researchers that have worked in pavement research for many years and are at the forefront of pavement technology.

The French LCPC and SETRA have many experienced pavement engineers with careers dedicated to pavements. All French engineers in public works graduate from the same university. The French are clearly not satisfied with the status quo in pavement engineering. The French program of cooperative research was very impressive to the Study Tour.

Many of these engineers have the ability to travel to international conferences and serve on international committees (e.g., PIARC and TRB).

#### **Toll Road Financing and Engineering**

The Study Tour was very impressed with the French toll road companies (COFIROUTE and SAPRR). France has depended heavily upon toll financing for the development of their rural motorway system. Currently toll rates are about 11 cents per mile or about 50 percent higher than the USA average toll rate.

The pavements were in very good condition and COFIROUTE and SAPRR appeared to make efforts to provide exceptional service to highway users. Feedback from users was obtained continually and was used to improve service levels. The toll agencies seek constant feedback from motorists on pavement condition, safety, and various service area aspects.

Therefore, they choose their pavement designs based on both cost and quality-of-service considerations. High-quality pavements mean a smooth, low-noise surface and a safe ride. Adequate funds are available to maintain these pavements in a very good condition and to construct pavements that will provide a long service life with low maintenance. These pavements are maintained in a better condition than pavements which are not on toll roads.

## 2.2 Implementation of Promising Technology in USA

The mission of the Study Tour includes the development of appropriate recommended actions for enhancing our nation's highway system, productivity and economic future. Those technologies and ideas that may show promise for implementation are summarized in this section.

### • Design-related Technology

✓ **CRCP/Doweled JPCP:** Use a long design life (30-50 years) for heavily trafficked highways, especially near or in urban areas. Future disruption of traffic will increase congestion and accidents. Concrete mixtures can be designed and constructed with durable characteristics to last even longer than this time period. Note that this recommendation is also given in the 1986 AASHTO Design Guide for urban areas.

✓ **JPCP/CRCP:** Continue to refine procedures for determining long-term increases in truck volumes, axle loads, tire pressures and use of super single tires in pavement design. Within this decade the USA is likely to experience the types of truck loadings now seen on Europe's highways.

✓ **JPCP/CRCP:** Emphasis should be on the total pavement system, not just the thickness of the concrete slab. Concrete pavement design in the USA seems to focus on the slab thickness, which, based upon observations of European pavements, is not the most effective design. Actually, the facts

show that concrete pavement slabs being built in Europe today are not thicker than in the USA. However, they do have several design features which more than adjust for the need for thicker slabs, including the following: thicker and more durable bases and subbases, bonding of treated bases to the slab, interlayers to prevent erosion, doweled joints clustered in wheel paths, widened traffic lanes, tied concrete shoulders, subdrainage and higher concrete strength.

✓ **JPCP:** Unique German concrete pavement design. This jointed plain doweled concrete pavements design has proven to give excellent performance in Germany for many years. This design should be tested in the USA to determine its cost, constructibility and performance. Actually, some pavements in the USA have many of the same design features as the German design and have performed well. However it is the details (such as the bonding of the slab to the lean concrete base after jointing the base) that often make or break the success of a design.

✓ **JPCP/CRCP:** Thick granular layer on subgrade beneath treated base. This layer has the following characteristics: 30-cm (12-in) thickness or greater depending upon subgrade soil stability, adequate thickness to protect against frost heave, and limited fines content to allow for some drainage through the layer. The philosophy in several European countries is that this layer should provide a certain minimum level of support that is the same for all

pavement types (a field bearing test is used to determine adequacy). This plate bearing test is not exactly the same as the conventional test used in the USA. The minimum required modulus of elasticity as measured on top of the granular layer appears to require very good support on which the lean concrete base or CTB is constructed.

✓ **JPCP/CRCP: Catalog of designs.** The design catalog has achieved widespread popularity in Europe, probably for at least three main reasons. First is the improved communication of specific pavement designs to management, contractors, and agency construction personnel. Second, the designs in the catalog are often the result of a combination of both theoretical analyses using sophisticated procedures and programs, and engineering and construction experience. Third, the design catalog can be easily modified.

Another reason, especially valuable for concrete pavements, is that all of the details of the specific cross-section can be provided including all transverse and longitudinal joints, load transfer, reinforcement, tie bars, drainage, shoulders, etc. to reduce the potential of errors in construction. The exact type of catalog and its format for successful use in the USA must be carefully planned. Such a catalog would help all involved in pavements to focus on the best practices.

✓ **JPCP/CRCP: Provide adequate full-width concrete and base paving thickness for future traffic control needs during rehabilitation of pavement or bridges or emergencies.** Change the terminology from "shoulder" to "emergency lane" to reflect this design philosophy.

✓ **JPCP/CRCP: Use widened truck lanes.** The advantages of widening truck lanes by approximately 0.5 m (1.6 ft) include greatly reduced edge stresses to almost interior loading levels. This reduces transverse cracking and reduces corner deflections which cause erosion, faulting, and diagonal/corner cracks. The best structural design is to have both a widened traffic lane and an adjacent tied concrete shoulder/emergency lane. Note that the paint strip must be placed 0.5 m (1.6 ft) from the edge of the slab to achieve the benefits of reducing critical edge loads by trucks.

✓ **JPCP: Joint designs to improve performance.** Several transverse joint design improvements are described below.

☛ Notch or joint and then bond the lean concrete or cement-stabilized base to the JPCP slab. The bonding of these layers provides a thick monolithic slab, which decreases flexural edge stresses, deflections, thermal curling, moisture warping and interlayer erosion leading to faulting.

☛ Varying dowel placement across traffic lane to concentrate on heavy truck wheelpaths to reduce costs.

☞ Short (5-m (16.5-ft)) joint spacing used for JPCP over treated bases.

☞ Required use of dowel bars to control faulting for heavy traffic. (These are already used by most agencies in the USA.)

☞ Plastic coating on dowels and center third of deformed tie bars, as done in Germany. Epoxy-coated dowels are used extensively in the USA; however, the plastic coating used in Germany appeared to be quite substantial.

✓ **CRCP: Longitudinal reinforcement.** CRCP has performed extremely well in Europe (Belgium, Spain, France) for many years and has been built recently in several other countries. Some reasons for its good performance:

☞ Increased steel (0.85 percent) has given excellent long-term performance on many projects in Belgium and a few projects in France (0.72 percent) and Spain (0.73 to 0.85 percent).

☞ Steel placed closer to the surface will hold cracks tighter and greatly reduce punchout development. This is the experience of European engineers and experimental sections in the USA have shown the same results.

☞ Rectangular, coilable steel strips (product name FLEXARM) should be tested in the USA to assess their advantages and performance. The steel percentage must be carefully designed for USA conditions.

✓ **JPCP/CRCP: Two-layer slab construction.** This is an economical design, especially where either a longitudinal brush texture or exposed aggregate surface is desired and suitable hard aggregates are very expensive, or where local aggregates are too soft to be used for the surface layer. The water/cement ratios of the two layers must be equal.

✓ **JPCP/CRCP: AC layer between the concrete slab and a treated base if notching or jointing is not done.** The purpose of this layer is to reduce erosion between the slab and treated base. This has been tried in the USA in at least one State and stripping of the AC layer occurred. However, more effective anti-stripping tests and remedies are now available. This alternative deserves consideration by agencies unwilling to notch and bond lean concrete bases to the slab.

✓ **JPCP/CRCP: Trapezoidal cross-section.** This design has had widespread use in two countries. It basically provides, for the same cost, an additional safety factor for structural fatigue. For example, if a four-lane divided freeway pavement design requires a 25-cm (10 in) slab thickness for the outer lane, providing a slab that varies from 22 mm to 28 cm (9 to 11 in) from the edge of the inner lane to the edge of the outer lane would provide considerably more structural reliability at the thickened longitudinal edge (28 versus 25 cm (11 versus 10 in)). The lanes must, of course, have adequate tie bars to hold the slabs together tightly and maintain good aggregate interlock.

✓ **JPCP/CRCP: Geotextile drainage fabric between slab and base.** The performance of this interesting design is not documented yet. This was being placed in France between the CRCP and the existing dense aggregate subbase of an old AC pavement. The thick fabric is supposed to provide both a filter to inhibit fines movement and a permeable layer to remove moisture.

✓ **JPCP/CRCP: Porous concrete base under shoulder.** This alternative seems to be very practical and useful to help drain the pavement section. An appropriate drainage system must exist for the porous layer.

✓ **JPCP/CRCP: Longitudinal edge drains connected to closed drainage system.** This German system of drains provided for both surface water and subsurface water drainage.

✓ **JPCP/CRCP: Ditch line a minimum of one meter from the bottom of the base.** This design should reduce the amount of water in the base layer and at the top of the subbase.

✓ **JPCP/CRCP: Solutions for bridge approaches.** Two interesting solutions to the problems of excessive pavement end movement and settlements at bridges were observed.

☛ **End lug to protect structure and AC transition surface layer that can be easily leveled up.**

☛ **Paving directly over the bridge deck where the bridge is designed for the extra dead load.**

## • Construction-related Technology

✓ **Warranties for pavement construction work.** While warranties ranging from one to nine years are being used in Europe for various aspects of pavement construction, there was not adequate information available to assess their impact. Much more specific information is needed about the details of these warranties. Implementation of warranties would need a long phase-in period in the USA.

✓ **Construct straight cross slope with no crown across traffic lanes.** This technique should provide improved rideability. A 2.5-percent slope, used in Europe, may improve surface drainage also.

✓ **Liquidated damages = Incentives rate per day for a given construction project time limitation.** Contractors felt that this was a fair specification.

✓ **Prevention of joint reservoir sawing residue from entering joint.** The practice of using a long rubber band stretched across the joint and squeezed into the first narrow cut appeared to be simple and effective.

✓ **Two-layer paving equipment.** Paving equipment capable of placing two separate concrete mixes with a single pass is available.

✓ **Re-bar tubes placed behind vibrators for CRCP.** This should improve positioning of bars, but needs further study.



✓ **Lean concrete used for temporary widening for traffic control.** The Berlin A10 project included a lean concrete traffic lane placed adjacent to the existing old concrete pavement to increase the number of traffic lanes during construction. This lane was ultimately recycled along with the rest of the adjacent older concrete after fulfilling its purpose. This technique may be cost-effective on some projects.

- **Maintenance and Rehabilitation Related Technology**

✓ **Unbonded CRCP and JPCP concrete overlays of existing concrete pavements.** Designs included fracturing the existing concrete (pieces less than 0.5 m (1.6 ft)) and placing an interlayer of one of the following: thin AC, lean concrete, or thick geotextile fabric. Excellent performance was achieved in several countries.

✓ **JPCP and Fiberized concrete overlays of existing AC pavements.** This is potentially a cost-effective long-term solution for badly cracked or rutted AC pavements. Construction procedures are standard for JPCP and performance has been good. Fibrous concrete overlays of AC pavements have worked well in Belgium.

✓ **Complete recycling of concrete and other materials on the job site.** This requirement may become standard practice in densely populated areas of the USA, as it currently is in some European countries due to environmental concerns (shortage of landfill space, etc.)

✓ **Rehabilitate pavements at a higher condition level.** European agencies appear to rehabilitate pavements at higher levels of condition than USA agencies. This may have significant user-related, economic, and structural benefits for the infrastructure over the long run.

✓ **Lane reconstruction designs.** The French and German designs are quite different but both have some very interesting features that should be of interest in the USA. Lane reconstruction would be useful on many USA pavements where only the outer one or two lanes are badly deteriorated.

✓ **Lane replacement or addition for AC pavements.** Replacement of an existing deteriorated AC pavement outer truck lane with concrete or construction of an additional outer lane with concrete pavement to serve heavy truck traffic has worked well in France and has applicability in the USA.

✓ **French LCPC/Freyssinet load transverse devices.** Extensive research shows that this device is effective in restoring load transfer. The cost-effectiveness is unknown.

- **Concrete Materials-Related Technology**

✓ **Improved concrete quality control for durability.** The absence of concrete durability problems in Europe speaks for itself in comparison to the many durability problems from "D" cracking, ASR and freeze-thaw spalling in the USA. Further investigation is needed

of the specific QC programs in various countries such as Germany, Austria and Switzerland which have colder climates. Rapid determination (within an hour) of the air void system using fresh concrete in Germany (using the Denmark equipment) was impressive, as well as Switzerland's determination of the air void system in hardened concrete from cores in 36 hours.

✓ **Higher-strength concrete for pavements.** Several European countries are routinely specifying higher-strength concrete. Belgium specifies a minimum compressive strength minimum of 55 MPa (7975 psi). This results in a typical mean of 70 MPa (10,150 psi) at 90 days. Typical flexural strengths have a mean of 7.5 MPa (1,087 psi) in third-point loading at 28 days. The extremely good long-term performance of these concrete pavements is due in part to their high strength.

✓ **Thick porous concrete slab.** A French technological forecasting committee concluded that a free-draining surface would be a major improvement due to its noise reduction, elimination of hydroplaning and storm runoff reservoir capabilities. At least one street has been built in Paris having a porous slab about 40 cm (16 in) thick. Further research is needed.

✓ **Recycling concrete that includes AC material.** This technique would reduce the cost of recycling concrete

back into concrete, particularly where an AC overlay exists over a concrete slab. Extensive research in Austria shows that a limited amount of AC is not detrimental to a concrete mixture. A few recycling projects containing AC particles have been completed in the USA.

✓ **Lean concrete used for shoulders (or emergency lanes) and lane widening during traffic control.** There may be several innovative uses for lower-strength and lower-cost concrete.

✓ **Fibrous PCC (steel fibers).** The thin fibrous concrete overlay of a rutted AC pavement in Belgium was impressive. Some of these have been built in the USA also.

#### • **Surfacings-Related Technology**

✓ **Longitudinal light texturing for noise reduction.** Several different longitudinal methods are being used that significantly reduce noise levels yet still provide adequate friction.

☛ **Longitudinal texturing produced with a burlap drag and smaller top-sized aggregates produce low noise levels in Germany.**

☛ **Longitudinal texturing produced by a combination of brush and comb achieves both microtexture and macrotexture (initial grooves were 0.7 to 1 mm (0.027 to 0.039 in) deep), which produces low noise levels in Spain.**

✓ **Porous surfacings.** These surfaces produce the lowest noise levels, give a smooth ride, eliminate splash and hydroplaning, and provide good friction capabilities, but their life is short and they clog with fines.

✦ **Porous AC surface (with polymer) 4 cm (1.6 in) thick.** Many countries have used a porous AC surface for old and new concrete pavements. It has some significant disadvantages such as clogging, poor durability and black ice formation in winter.

✦ **Porous concrete (with polymer) surface 4 cm (1.6 in) thick.** This has been built in at least two countries. It also has the same clogging problem as the porous AC surface but may have a longer life.

✓ **Exposed aggregate surface.** A surface texture with low rolling noise and low vehicle vibration but high friction is achieved through the chemically exposed aggregate technique. This surface has been shown to have a long life. It can be accomplished most economically using a two-layer slab with smaller hard aggregates in the upper layer or a hard aggregate of somewhat smaller maximum size through the full slab depth.

✓ **Diamond grinding surface for noise reduction (existing pavement).** Longitudinal grinding reduces noise.

✓ **Surface layer of epoxy/fine grained aggregate for noise reduction (existing pavement).** An epoxy resin binder is applied to a hardened concrete surface,

followed by a layer of crushed 3- to 4-mm (0.12- to 0.16-in) chromium ore slag, and the surface is then rolled to produce a mosaic-like structure with a low noise level.

✓ **French double surface treatment (existing pavement).** A thin surface consists of a spray of polymerized asphalt on the concrete surface, a layer of 1.4-cm (0.55-in) chips, and then a layer of 1-cm (0.4 in) chips placed with no compaction. This surface treatment reduces noise significantly.

#### • **Research and Development Related Technology**

✓ **Closer government and industry cooperation.** It is obvious that Europe benefits greatly from close cooperation between public and private organizations. Cooperation is growing in the USA. The existence of close working relationships among industry, State, and Federal officials is one of the reasons why this tour took place. Institutionally, the USA needs to keep the momentum going by supporting activities such as the AASHTO-ARTBA-AGC Joint Task Force; industry involvement in research and technology advisory efforts with TRB, NCHRP, and FHWA Technical Working Groups and Expert Task Groups; the University Transportation Centers; and expanded partnerships in research agreements through implementation of the Stevenson-Wydler Technology Innovation Act of 1980 (ISTEA Sec 6001).

The great benefit of close interaction between groups appears to be considerable innovation and practical results that actually get used on the highways because all concerned were involved in their development and have a stake in their success.

✓ Construction of selected European concrete pavement designs in the USA to evaluate constructibility, costs, and performance. Several highly promising candidates are available. Note that different surfacings could be tested for any of these designs. The design and construction of several innovative European sections is recommended.

☛ The German design for JPCP has provided many years of excellent performance. The construction of the German section in Michigan is fully supported and should lead to special attention to increase foundation support.

☛ The Belgian design for CRCP (with the higher steel content) has performed for over 20 years under heavy traffic with no punchouts.

✓ The French trapezoidal CRCP or JPCP design (one or two layers) has been used extensively for one- to two-lane replacements with good success.

✓ The Austrian JPCP design with two layers is being constructed on many heavily trafficked highways.

The SHRP SPS-2 effort might be employed for at least some projects.

✓ Accelerated field testing of concrete pavements. The French LCPC/Nantes circular test track is currently testing a variety of concrete slab designs. It is recommended that a task group be formed to determine the USA needs in accelerated performance testing of concrete pavements. After the testing needs have been identified, the task group should develop a proposal outlining the requirements and procedures required to meet these needs.

✓ Increased R & D budgets for pavements. Most European countries appear to be conducting more pavement research than the USA, as a percentage of total funding spent on the highway network. The Strategic Highway Research Program (SHRP) was a recent step forward to increased funding for pavement-related R & D, and now the new 1991 highway bill (ISTEA) provides additional R & D for highway research. The increased expenditures for R & D through ISTEA in both HP & R funding and in the NCHRP program are also very positive movements. This trend towards increased funding for highway R&D needs to continue. It would behoove the pavement-related industries to make a very strong case for the needs and the benefits of pavement research in order to obtain a fair share of this funding. While much of the funding is related to federal investment, more private sector funding, industry partnerships and implementation of the previously mentioned Stevenson-Wydler Technology Innovation Act of 1980 (ISTEA Sec 6001) can help stretch the funds.

✓ **Innovation, willingness, and eagerness to try new ideas.** State and local highway agencies are complemented on their increased commitment to research and development in improving concrete pavements as are similar organizations in Europe. In addition, an increased effort needs to be made in the USA for innovation in all aspects of pavement engineering as is being done in countries like France.

✓ **Global view: exporting technology by licensing R & D products.** The French hold this point of view very strongly. Many developments by the French national LCPC laboratory are subsequently licensed for commercial usage. Many products are jointly funded and developed. FHWA's recent opening of foreign exchange programs with Europe and Asia are to be complemented. The joining of PIARC, especially, is much appreciated. To help the American economy, we must continue to develop a global view of the enormous benefits in developing improved pavement designs, construction specifications and techniques, equipment, maintenance and rehabilitation designs and especially improved materials.

✓ **Implementation of research.** It must be realized that the level of effort needed to implement any procedure or product developed under a research study is significant, and may be several times more than the original research study. The researcher should guide the field implementation along with a team of engineers from operations and industry until the procedure or product

is working as intended. This concept could help develop a partnership between research and operations that is needed for successful implementation. The increased funding and recent reorganization of FHWA's office of Technology Applications is a very positive step forward, as is FHWA's general direction toward a more technology-centered mission.

- **Improving Engineering Expertise**

With the complex changes that have occurred in pavement engineering -- rehabilitation strategies, new materials, life-cycle costs, user costs, weigh-in-motion data, remaining life concepts, increased and varied truck traffic, and now feedback from pavement management systems -- it is obvious that the education of the country's next generation of pavement engineer needs to be restructured. Needs include:

- ✓ **Improved pavement engineering education in colleges and universities.**

- ✓ **Additional short courses in all aspects of pavement engineering for practicing engineers and construction and maintenance personnel.**

- ✓ **Increased priority in public and private organizations for training their staff in pavement engineering and construction.**

- ✓ **Increased interaction of pavement engineers and construction personnel, within States, regionally, and nationally. Additional travel funds must be made available for this important activity.**

✓ Establish at the national level a focal point for collecting information about developments in the USA and other nations in pavement technology, and distributing the information to pavement engineers, researchers, and the construction industry. This effort should include and could be based upon the continuing SHRP effort, and should include a broad-based advisory board.

### 2.3 Benefits to the USA of Implementing Some Innovative Technology

Looking for a moment at the BIG broad picture of the nation in the context of what the Study Tour experienced in Europe, the following thoughts about the benefits of implementing the above recommendations emerged from the Study Tour participants.

- Improved pavements will result in fewer lane closures for pavement repairs: reducing congestion and its associated problems (i.e., wasted time, delivery delays, accidents, air pollution, and fuel consumption).
- Improved pavements will result in fewer accidents, injuries and fatalities due to improved pavement surfaces and fewer lane closures, which always increase the potential for accidents.
- Improved pavements will improve environmental conditions for people living and working near highways due to reduced noise levels and reduced air pollution from less congestion.

- Improved pavements will increase driver and passenger comfort and decrease vehicle user costs due to smoother, quieter surfaces and also fewer traffic delays from lane closures.

- Improved pavements will provide in a much more efficient highway transportation system overall that will greatly contribute to economic growth and help to keep the USA competitive with Europe, Japan and other countries with highly efficient transportation systems.

Concrete pavements will play an important role in the continuing improvement of the nation's highway, street and airport system, especially in light of growth in truck and aircraft traffic volumes and weights. This is also the belief of many pavement experts in Europe. However, new and innovative technology and training is needed, along with implementation of these innovations, to provide improved designs, materials, construction quality and rehabilitation of these pavements. To that end this report is dedicated.



### 3 COUNTRY SUMMARIES

This chapter provides summaries of the US TECH Study Tour of concrete pavements in France, Austria, Germany, Netherlands and Belgium. In addition, brief summaries of information obtained from presentations by representatives of Spain, Italy, Switzerland and Portugal are provided.

#### 3.1 France

- Concrete Pavements in France

Concrete pavements have been used on the French freeway system since its beginning, starting with a few sections built from 1939 to 1960. The real growth dates from the 1960's when the "California" design was adopted with undowelled jointed plain concrete pavements (JPCP) placed on an

erodible cement-treated base with no subdrainage. The rapid growth of heavy truck traffic in the 1970's (10 percent per year) led to problems with pumping, joint faulting and slab cracking. (Note that there is considerably more rainfall in France than in southern and central California.) These problems damaged the quality reputation of concrete pavements in France and limited their use. (1)

It should be pointed out, however, that a number of these pavements are still in service on various heavily trafficked freeways in France. The Study Tour traveled on several of these pavements, such as the 30-year-old section of the heavily trafficked A6, shown in Figure 3.1, built in the 1960's south of Paris (an outer lane has been added).



Figure 3.1 Thirty-year-old JPCP section of the A6 south of Paris. (Note added lane with widened edge.)



It should be noted that these JPCP have carried many times their original design traffic and have actually performed extremely well on that basis. For example, one undowelled, undrained JPCP section had received 17 million heavy commercial vehicles over a 12-year span before it was rehabilitated. These vehicles are more heavily loaded than in the USA: the legal single-axle limit is 13 metric tons (t) (28,700 pounds).

However, in France as in every country visited, this level of quality is not acceptable and there has been a continuing effort to improve this design. Through the years, French engineers, researchers, contractors and industry have worked hard to improve concrete pavement design, materials, and construction. Many innovative designs have been adopted as the result of this highly cooperative work.

Concrete pavements today account for more than 900 km (560 mi) of freeways, including about 200 km (124 mi) of overlays, or 15 percent of France's freeway system. Concrete pavements have also been built on secondary roads and airports. This share is growing steadily. Currently 30 percent of the pavements completed each year on the French freeway system are concrete. (2)

All of the early pavements were JPCP, and these are still being constructed with modified designs. However, CRCP has become very popular in certain areas of France. CRCP was first constructed in France in 1983 and now France has over 550 lane-km (342

lane-mi) of CRCP freeways. CRCP has been used in rebuilding over 100 km (62 mi) of truck lanes on existing concrete and AC highways. It has also been used on airports. (1)

- French Toll Road Companies

One of the most significant aspects of the French highway system is the eight toll road companies that build and operate 6,000 km (3,730 mi) of major freeways (7,000 km (4,350 mi) total). Seven of these are semi-private (over 50 percent of the shares are owned by the government) and one is private (owned by several contractors). The Study Tour was hosted by two toll road companies: Societe des Autoroute Paris-Rhine-Rhone (SAPRR), a semi-public company, and Compagnie Financiere et Industrielle des Autoroutes (COFIROUTE), a private company. In the 1960's there was a great need to build the proposed 4,000-km (2,580) nationwide network of motorways, but the public funding available was inadequate. The SAPRR company was created in 1961, and has constructed and operates 1300 km (808 mi) of freeway. In 1970, COFIROUTE, France's first private highway concessionary company was created. COFIROUTE has now constructed and operates 730 km (454 mi) of freeways. Their main program currently is widening from four lanes to six lanes due to increases in traffic.

The Study Tour was very impressed with the extent to which these toll road companies are vitally concerned with providing the highest quality service to users and are constantly seeking to

improve service levels. They seek constant feedback from motorists on pavement condition, safety, and various service area aspects. Therefore, they choose their pavement designs based on both cost and quality of service considerations. High-quality pavements mean a smooth, low-noise surface and a safe ride. Adequate funds are available to maintain these pavements in very good condition and to widen and construct pavements that will provide a long service life with low maintenance. These pavements appear to be maintained in better condition than pavements which are not on toll roads.

- **Designs**

A comprehensive design catalog was published in 1988 for the standard design of pavements in France. This catalog provides alternative designs based upon traffic level and foundation support. France has designed and constructed two general types of concrete pavements: JPCP and CRCP.

**Original JPCP Design.** The original 1960's design for JPCP had two major flaws: it did not include adequate load transfer at the joints and the cross-section was a bathtub with no subdrainage. Due to very large truck axle loadings (13-t (28,652-pound) single-axle loads), large numbers of loadings and a wetter climate than California, these pavements developed pumping, faulting and then cracking.

**Design Modifications to JPCP.** To eliminate the above problems, major design changes have been made over the years.

- ✓ The cross-section was modified to a trapezoidal section so that a thicker slab is on the outer edge of the truck lane as illustrated in Figure 2.3, while the amount of concrete material and cost are not increased. The truck lane was widened so that loads do not roll along the edge causing high bending stresses and high corner deflections.

- ✓ An erosion-resistant lean concrete base (7-8 percent cement) is also placed under the slab and longitudinal drainage of various types is placed along the edge joint.

- ✓ Load transfer at transverse joints was improved through use of dowels, shorter joint spacing (4 to 5.5-m (13 to 18 ft)) and/or a thicker slab. Most of these pavements have not been built with dowel bars as France has used dowels only on selected projects.

The above JPCP designs have been used on new construction as well as major reconstruction of existing lanes on freeways. For example, the very heavily trafficked A1 freeway originally had an undowelled JPCP without drainage that required rehabilitation after 12 years and 17 million heavy trucks (one lane).

In 1976 this pavement was partially reconstructed as shown in Figure 2.3. This new pavement had carried some 35 million trucks on the most heavily loaded lane by 1988, or more than twice its design traffic. Pumping developed gradually on this pavement until 1988 when the subdrainage system was found to be completely clogged. (7)

Another example of a heavy-duty lane reconstruction included dowelled joints on the A6 freeway in 1985.

An example of a JPCP built in 1978 was a thick concrete slab (39 cm (15.5 in)), no subbase, a geotextile drain placed over the subgrade, and short joint spacing (4.5 m (15 ft)). After 14 years of traffic, this pavement is performing well. France considers this a good design for routes with less than 1500 trucks per day.

A very important issue in France is the wearing surface of the pavement. Several types of surfaces have been constructed for reducing noise, increasing friction, and reducing hydroplaning, including stone chips on the fresh concrete surface, an exposed aggregate finish, a thin surface layer of porous asphalt, a thin double layer surface treatment, and some porous concrete surfaces. These are described under Surfacing.

Hot-pour polymerized asphalt and preformed compression seals are used for JPCP joints. Joints are generally skewed 1:6 counterclockwise to allow wheels on the left, far from the outer slab edge, to hit the joint first.

**Design of CRCP.** The design varies in thickness depending on current truck traffic and subgrade soil modulus. Either a 15-cm (6-in) lean concrete base or a 5-cm (2-in) AC layer is used directly beneath the CRCP. In addition, a thick layer of select granular material or cement-stabilized soil is usually placed beneath this base layer. Total width paving for a freeway is 8 m (26.5 ft), two traffic lanes including 0.5-m (1.6-ft) widening

of the outer lane. Tied concrete shoulders (sometimes lean concrete) were observed on many highways. Some CRCP are constructed with a trapezoidal cross-section having varying thickness across two lanes. Some examples:

New freeway pavement = 19 to 25 cm (7.5 to 10 in) (thicker for heavier trucks observed)

New (truck) lane widening = 31.5 cm (12.5 in) observed on one section

Overlay placed on old JPCP = 180 cm (7 in) minimum

Overlay placed on old AC = 16 cm (6.5 in) minimum

Deformed longitudinal reinforcing bars (diameter 1.6 mm (0.63 in)) with a yield of 590 MPa (71,000 psi) have been used in the past. The steel percentage is 0.67 percent and is placed at a depth of 8 cm (3 in), about one third of the slab thickness, which helps greatly in holding the cracks tight. This design has resulted in very tight cracks with few punchouts. Transverse reinforcement is also used to tie the lanes together. One bar (1- to 1.4-cm-diameter (0.4 to 0.55 in)) is placed per meter (3.3 ft).

The shoulder is either AC with a pervious aggregate base or a porous concrete base, or tied lean concrete placed on a non-woven geotextile drainage layer (at least 5 mm (0.2 in) thick). Longitudinal drainage is provided at the edge of the slab to prevent erosion.

The French have several ways to treat the CRCP ends at bridges: provide expansion joints, roughen the surface of the subbase to promote high bonding, or if the bridge is designed for the extra weight, placement of the CRCP directly over the bridge deck. (4)

The SAPRR toll road company does a 25-to 30-year life-cycle cost comparison among pavement types. About one half of the time concrete wins and the other half asphalt wins, depending on traffic and soils conditions.

**New Reinforcement for CRCP.** Due to the length of the construction train and the complexity of bar reinforcement placement, the possibility of using long coilable reinforcement was considered to reduce the length of the construction train and the labor required for steel connection. A photo of a construction site using coilable reinforcement is given in Figure 2.6.

Research in France had shown that it was critical for the concrete to bond to the steel to keep cracks tight, and this led to the idea of developing reinforcement which would have as large a surface area as possible in contact with the concrete, thus increasing bond. This led to flat reinforcement which had the advantage of being coilable for ease in transporting and in construction. The result was the development of coilable strips with high bond to concrete and a high yield strength.

This reinforcement has been used in France since 1988 for several major freeway projects under the commercial name of FLEXARM. (4) This carbon steel has a high yield strength of 790 MPa (114,550 psi), a flat, rectangular section 4 cm (1.6 in) wide and 2 mm (0.08 in) thick, corrugated by hammering both sides, and a surface which is corrosion-proofed by continuous hot galvanization. It is supplied in coils of 360 or 500 m (1180 or 1640 ft), and joined in the field by rapid pneumatic riveting. Advantages reported by users include a shorter work zone, increased construction productivity and associated decreased duration of the work, the ability to pave one lane of CRCP at a time, and improved safety. The Study Tour viewed two sections of the A6 freeway constructed with FLEXARM (discussed later in this report).

- Research Underway at LCPC Nantes

A national research project is underway at the LCPC Nantes laboratory on concrete pavements that includes a combination of public and private organizations (IREX). This research approach appears to be a model of cooperation to achieve the maximum of innovative and practical results for the funds spent. Research topics include design, crack control, porous concrete, and roller-compacted concrete. Three-dimensional finite element techniques are being used for developing structural designs (CESAR).

The thick porous concrete slab concept is under development. This is defined as a porous concrete base surfaced with a free-draining concrete layer having a total thickness of 40 cm (16 in). This pavement substantially reduces traffic noises and acts as storm reservoirs for runoff water in urban areas. This design is highly promising for urban highways and streets, but they must be maintained to prevent clogging. (1) One project was reported to be constructed in Paris for drainage and splash control.

The LCPC Nantes Test Track experiment is a major part of this national research project in concrete pavements. (11) The Study Tour observed the large test track (shown in Figure 2.17) in operation and saw some of the early results obtained. One million loads per month can be placed on the concrete pavements and with three separate tracks, testing can be maintained while new sections are constructed. Loads from 8 to 18 t (17,600-39,700 pounds) can be placed on single or dual tires. The current experiments underway include JPCP with and without dowels, lean concrete base (not bonded), aggregate base, geotextile layer for drainage and lean concrete as a slab. Some cracking of sections has occurred. The lower-strength lean concrete section has shown considerable fatigue cracking. This was an impressive experiment.

- Rehabilitation

French research has developed several types of pavement monitoring equipment. The Gerpho (similar to

PASCO) takes 35-mm continuous strip photos of the pavement for visual distress. The APL provides longitudinal profile and also joint faulting. The LaCroix Deflectograph measures deflection. The SCRIM device measures friction. The latest equipment development is the SIRANO (profile, 35-mm film, and macrotexture, at a speed of 72 km/hr (45 mi/hr)) which was used to test 5500 km (3,415 mi) in 1991.

A comprehensive evaluation is conducted to determine the need for and design of pavement rehabilitation. A policy of prevention is encouraged, by which rehabilitation action is taken as soon as fatigue damage (cracking) is observed.

Several different rehabilitation alternatives have been used in France to rehabilitate the original JPCP built with no dowels.

**Restoration of Load Transfer.** Lack of adequate joint load transfer and poor subdrainage led to pumping, faulting and cracking of the original JPCP. The placement of shear devices, the latest version called LCPC/Freyssinet connectors, at transverse joints has extended the life of some projects. A description of this device is given under Project Sites Observed.

**Lane Replacement or Addition with New JPCP.** This technique has been used extensively in the Paris region for existing JPCP freeways. See discussion and typical designs described under Design and shown in Figure 2.1.

**Lane Replacement or Addition with New CRCP.** SAPRR stated that they expect continued large increases in trucks with the coming of the EC and therefore, have constructed several projects involving the replacement of the outer traffic lane, originally AC pavement, that is used almost exclusively by heavy trucks. Because of serious deterioration in these outer lanes, they began either rebuilding them or adding a new lane using CRCP. One site visited is described under Project Sites Visited. (6)

**CRCP overlays.** Many CRCP overlays have been placed on existing JPCP pavements. A description of one such project is given under the section titled Project Sites Visited. This alternative has performed very well.

**JPCP Overlays on AC Pavement.** Several experimental overlays were placed in the 1970's and have reportedly performed very well after many years. Their typical slab thickness was 21 to 25 cm (8.5 to 10 in), and the joints are typically spaced at 4.5 m (15 ft) and are undowelled. These projects carry 600 to 1000 trucks per day in one lane. The new JPCP overlay is placed directly on the old pavement, or onto a leveling course of lean concrete. (7) Others have been placed since that time.

- **Surfacings**

As in other European countries, pavements with low noise, high friction and smooth ride are extremely important in France. A good macrotexture is considered important in France, where the objective is a

texture depth of more than 1 mm (0.04 in) by the sand patch test. The method of transverse grooving of the surface of the fresh concrete with a brush or tine is no longer used. Detailed descriptions of these techniques are given under Project Sites Observed.

**Porous Asphalt Surface.** Many concrete pavement sections have been overlaid with a porous asphalt layer to reduce noise, improve rideability, increase friction and reduce hydroplaning. COFIROUTE, for example, has constructed many porous AC surfaces and also a porous concrete surface on concrete pavements.

**Double Surface Treatment.** A thin surface called a double layer has been placed to improve the rideability of existing pavements. The surface treatment consists of a spray of polymerized asphalt on the concrete surface, a layer of 1.4-cm (0.55 in) chips, and then a layer of 1-cm (0.4 in) chips placed with no compaction.

**Exposed Aggregate Surface.** France also uses an exposed aggregate technique similar to that used in several other countries. It is used with concrete containing aggregates that are not readily polishable. This may require two-layer construction where the two layers are placed simultaneously. The surface is sprayed with a retarder and then covered with a sheet of polyethylene to protect it from drying out and from the weather. After 24 hours the sheet is removed and the surface is scrubbed dry to expose the aggregate by removing the surface mortar. The surface is then

covered with a conventional curing compound. The surface provides low noise, good rideability, and good friction characteristics. (4)

**Porous Concrete.** A slurry of cement, polymer additive, filler (limestone) and water is mixed and then added to the crushed hard aggregate (4 to 6 mm (0.16 to 0.23 in)). This mixture is poured onto the concrete slab placed not more than two days previously, at a thickness of 3 to 4 cm (1.2 to 1.6 in), using a finisher with a vibrating compacting plate. During this operation, some of the slurry settles to the bottom of the layer bonding it to the concrete slab. Porous concrete surfaces have worn well, with no significant stripping of surface aggregate. (4)

- Concrete Materials and Construction

The concrete pavements observed did not have any durability problems for concrete as old as 30 years. High-quality concrete is achieved in France through three steps:

- (1) Aggregate properties optimized to minimize void content (continuous gradation),
- (2) Water and plasticizer used to achieve workability, and
- (3) Entrained air and cement contents selected for best strength.

After that, work at the job site must be performed well. Batch plants and continuous mixture plants are used.

The following are mean values for some large projects:

Slump:	5-8 mm (0.2-0.3 in)
Air content:	5.0 percent
Modulus of rupture:	5.2 MPa (754 psi) at 56 days, standard deviation 0.6 MPa (87 psi)
(Third-point loading	3.6 MPa (522 psi) at 7 days, standard deviation 0.4 MPa (58 psi)

Concrete recycling has been successfully done on several projects in France since 1976. (9)

Two-layer construction is done to provide a hard aggregate in the top surface. A description is given under Surfacing.

Contractors must warranty pavement projects for varying lengths of time: typically one year on the national highway system but longer on the freeway system. AC pavement is warranted for four to five years, concrete for seven to nine years and the various surfacings for five years for friction, cracks, spalls, etc. If problems develop, the contractor must repair the pavement over the warranty time period.

- Project Sites Observed

The US TECH Study Tour traveled extensively on the French freeway system, especially in the general vicinity of Paris and south. Several project sites were observed.

**A10 CRCP Widening Project (COFIROUTE Toll Road).** This highway carries 35,000 ADT and is being widened from 4 to 6 lanes as shown in Figure 2.11. This AC pavement was constructed in 1972, was overlaid in 1982 and again overlaid in 1989. The existing shoulder material was removed by milling down to the subbase, which was crushed limestone aggregate 30 cm (12 in) thick. After replacing any weak areas the material was recompact, a thick geotextile fabric layer was then placed, reinforcing steel was placed on chairs and finally the 31.5-cm-thick (12.4 in) CRCP was slipformed. The fabric is a two-layer system with a filter fabric as the lower layer and a more permeable fabric as the top layer to control pumping.

The CRCP was 3.8 m (12.5 ft) wide and contained 24 bars with a diameter of 2 cm (0.8 in). The percentage of steel (0.63 percent) is based on the split tensile strength of the concrete. A photo of the steel layout on the fabric is shown in Figure 3.2. Also note the thick limestone aggregate subbase. The new CRCP lane included a 0.3 m (1 ft) extra widening. The steel was placed 9 cm (3.5 in) from the surface on chairs and transverse steel was also included, as shown in Figure 3.2. The higher placement of steel is considered important in keeping the transverse cracks tight.

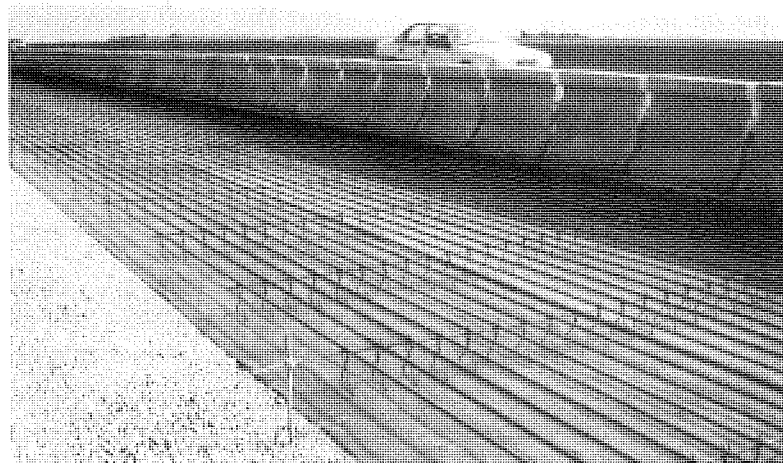

Figure 3.2 CRCP lane addition on the A10 south of Paris.



After one year of service, the same CRCP in the other direction has tight cracks with a mean spacing of 0.8 m (2.6 ft). This CRCP lane will be surfaced after about one year with a porous AC layer for low noise and good rideability.

The concrete mixing plant operation was observed. The plant was unusual in that it was a continuous-mix type of plant that produced 200 cubic meters (262 cubic yards) per hour. Air entrainment and plasticizer were used in the mix. Six samples were tested each day for air content, slump and compressive strength. This contract includes a four-year warranty on design and performance.

**A71 CRCP Project (COFIROUTE).** This project demonstrates the optimum use of aggregates in two-layer construction, the provision of an exposed aggregate surface with low noise and high friction characteristics, the accuracy to which reinforcement placed in tubes can be placed for a unique setup for the vibrators, and the construction of a trapezoidal cross-section. The CRCP was constructed in 1986 and consisted of a 7.85-m-wide (25.75 ft) trapezoidal cross-section (two traffic lanes with the outer lane widened) varying from 18 cm (7 in) at the passing lane edge to 20 cm (8 in) at the truck lane edge. Deformed longitudinal steel (1.6 cm diameter (0.63 in)) was 0.66 percent of the cross-sectional area. The depth to the top of the steel was 8 cm (3 in), or 0.42 of the slab thickness. The CRCP rested on a 5-cm (2-in) AC layer on a 35-cm (14-in) cement-treated sand layer. (3)

The CRCP slab was placed in two layers using specially designed equipment, separately vibrated in a single pass where the two layers did not mix. The top 5 cm (2 in) included hard aggregates (1-1.4 cm (0.4-0.55 in)) that give a low-noise, high-friction macrotexture. These aggregates had to be hauled a long distance and were expensive. The process to achieve the exposed aggregate surface is the same as that used in Belgium and several other countries. The bottom layer used local limestone aggregates for economy. Many cores were taken and the splitting tests showed an excellent bond between the layers. A substantial cost savings was achieved using the two-layer approach. (3)

The steel was placed using tubes on this project. The position of the tubes and vibrators are as shown in Figure 2.9 where the tubes extend almost to the front edge of the pan, which may improve the placement depth of the steel. Results of measurements show that the steel placement was excellent, with a mean depth to top of steel of 8 cm (3 in) and a standard deviation of only 8 mm (0.3 in). (3)

Figure 3.3 shows the widened lane CRCP with an AC shoulder (widening was 0.7 m (2.3 ft) from the inside edge of the paint stripe to the edge of concrete). The transverse cracks were closely spaced and very tight and the surface showed an excellent macrotexture. The longitudinal joint between the CRCP and AC shoulder was sealed with a polymerized asphalt sealant placed as an overband. This was performing very well after six

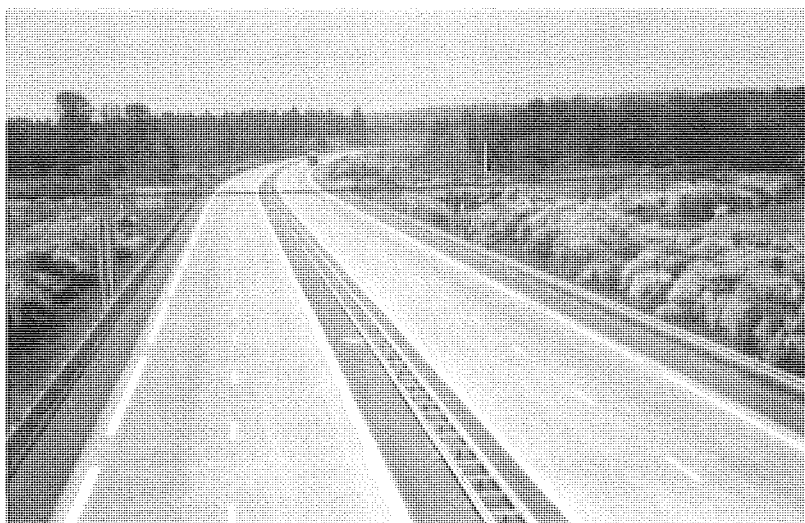

Figure 3.3 CRCP on the A71 trapezoidal cross-section with widened lanes.

years. Shoulders were 2 to 4 cm (0.8 to 1.6 in) of porous asphalt over 27 cm (10.6 in) of porous concrete. The section also has longitudinal edge drain under the lane/shoulder joint.

**A6 Freeway LCPC/Freyssinet Load Transfer Device.** This pavement was an undowelled JPCP constructed in 1958-60, with a 25-cm (10-in) slab on a 15-cm (6-in) CTB. The Freyssinet device is used to restore high load transfer in the transverse joints of undowelled JPCP. These undowelled joints exhibit poor load transfer, which leads to faulting and cracking of the original slab plus deterioration of reflection cracks in an AC overlay. These devices were developed by

LCPC and Freyssinet International and have been placed on many sections of JPCP in France with good success in restoring load transfer from less than 50 percent to over 90 percent.

A Freyssinet device placed in a transverse joint or crack is shown in Figure 2.12. Four devices are placed per joint if no pumping exists and six are placed per joint if pumping exists. They are placed using special equipment at a rate of 100 per hour. Devices are installed when joints are open so the device is always in compression. They consist of two symmetrical half-shells in cast iron, a steel key which slides in a housing machined in the half-shells, and a

central elastomeric sleeve providing water tightness to the unit and bonding the half-shells to the concrete pavement. The wheel load is transferred from one edge of the joint or crack to the other with high efficiency: from the concrete to one half-shell through bonding with epoxy resin, from one half-shell to the other via the key, from the second half-shell to the concrete by epoxy resin bonding. They carry a five-year warranty. (8, 12)

Two sections on the A6 were observed where the Freyssinet devices had been placed in the original JPCP joints and then a thin porous polymerized AC surfacing was placed. There was very little reflection cracking through the surface after two years of heavy traffic. The company warranties that very little cracking will occur in five years.

**Porous Asphalt Surfacing on CRCP.** The Study Tour traveled over several sections of CRCP that had been overlaid with porous asphalt. These surfaces provided low-noise and good friction and there were no reflection cracks. Areas in France where there are only soft aggregates presents a problem as to finding hard aggregate for the surfacings. One project tried to seed the hard aggregate onto the plastic concrete surface, but it resulted in a rough ride. Placing the porous asphalt surface permits the use of local, lower-cost aggregates in the slab.

**A6 Freeway CRCP Overlay With Bar Reinforcement (SAPRR Toll Road).** Several CRCP overlays exist along the A6. One CRCP overlay containing conventional bars was placed in 1986 over an old JPCP (constructed in 1964), as shown in Figure 3.4. The design

was as follows: 18-cm (7-in) CRCP with 0.67 percent steel and 18-cm (7-in) lean plain concrete shoulders, with transverse joints at 6 m (20 ft), placed on the fractured 25-cm (10-in) JPCP over a 15-cm (6 in) cement-treated base. The existing slabs were fractured by three to four drops of a guillotine breaker per 5-m (16.5-ft) slab. An existing asphalt surface treatment served as the bond breaker. A longitudinal drain was placed along the edge. The surface of the CRCP was an exposed aggregate as shown in Figure 2.15. The transverse cracks were tight and the pavement was in excellent condition. This overlay is typical of several observed.

**A6 Freeway CRCP With Surface Treatment (SAPRR Toll Road).** Some CRCPs had received a surface treatment called a double layer to improve the rideability. The performance of these appeared to be very good. The surface treatment consisted of a spray of SBS polymerized asphalt on the concrete surface, a layer of 1.4-cm (0.55 in) chips, and a layer of 1-cm (0.4 in) chips.

**A6 Freeway CRCP With 0.30 Percent FLEXARM Reinforcement (SAPRR).** A nearby section of CRCP overlay identical to the previous one (with conventional reinforcing bars) contained the new rectangular steel strips called FLEXARM, placed in 1988.



Figure 3.4 A6 freeway CRCP overlay with bar reinforcement (SAPRR Toll Road) and lean concrete shoulders.

The CRCP contains 0.30 percent steel placed in two close but staggered layers and was constructed in near-freezing conditions. The crack spacing was longer than usual and some of the cracks were spalling and had opened slightly. One explanation for the spalling was that it was caused by the surface treatment. However, the longer crack spacing may also be a major factor as well as the amount of rectangular steel.

**A6 Freeway CRCP With 0.34 Percent FLEXARM Reinforcement.** This is a nearby section of CRCP overlay constructed in 1990, identical to the previous one with FLEXARM

contained 0.34 percent steel content to reduce crack spacing. This pavement had a closer crack spacing, tighter cracks and no spalling. This steel content is currently being used on other projects.

**A6 Freeway CRCP With 0.72 Percent Bar Reinforcement.** This was the first CRCP placed in France, in 1983. It is a 20-cm (8-in) overlay that has performed with no structural deterioration under heavy traffic. This pavement had the highest steel content used in France.

The steel depth is 8 cm (3 in), closer to the surface, which has helped to keep cracks tight. However, the original finished surface and soft aggregate polishing required that a surface treatment be placed. The Study Tour was able to observe the outer 0.5 m (1.6 ft) edge along the CRCP which was not covered by the surface treatment. The transverse cracks were closely spaced and extremely tight. The local engineers stated that this was the best CRCP ever built in France.

**A6 Freeway Old JPCP.** A long stretch of 25-cm (10-in) JPCP with an added traffic lane was observed. The added lane included a widened outer edge as shown in Figure 3.1. (Note that this is the same cross-section described under the section on Design with the cross-section shown in Figure 2.3). This original pavement is one of many that dates from the 1960's, and the lane reconstruction was done in the 1970's or 1980's.

- **Traffic Loadings**

Traffic loadings are heavy in France, where the legal single-axle load limit is 13 metric tons (t) (28,700 pounds). Truck volumes in the outer lane range from 5,500 trucks per day to an astounding 10,500 on the A1. (2) Most of these trucks have super-single tires also. The typical ADT on the SAPRR toll roads is 20,000 with 20 percent trucks.

- **French Research Program**

The LCPC Nantes Test Track experiment is a major part of this

national research project in concrete pavements. (11) The Study Tour observed the large test track in operation and saw some of the early results obtained as discussed under the section "Research Underway at LCPC Nantes." The Study Tour participants were impressed with this experiment.

The French are clearly not satisfied with the status quo in pavement engineering. The French program of cooperative research conducted over many years was very impressive to the Study Tour participants. The SETRA and the national laboratories of LCPC have many experienced pavement engineers with dedicated careers in pavement engineering.

The national research study on concrete pavements appears to be an ideal example of the close working relationships between public and private organizations. Private organizations add funding to some of these studies that they consider very important. The great benefit of this appears cooperation to be considerable innovation and results that actually get used on the French highway system. Presentations made to the Study Tour included a combination of engineers from the French government, private contractors, corporations and the semi-public toll roads.

As an example of how to obtain innovation, SETRA recently requested research needs statements which have resulted in some innovative proposals which they hope to fund.

- Summary for France

Concrete pavements have been constructed in France on some of its most heavily trafficked freeways and airports over the past 30 years. France has worked very hard to improve the design, construction, and rehabilitation of concrete pavements for many years. Many innovative ideas have been developed over the years, such as load transfer devices, rectangular steel for CRCP, subdrainage, construction warranties, low-noise high-friction surfacings, lane widening designs, and the trapezoidal cross-section. The strong efforts to bring together public and private organizations to work towards the solution of concrete pavement problems has had a major effect on the success of their research programs actually impacting design and construction practice.

The French stated that "The maintenance and growth of the competitiveness of concrete-based road techniques depends on constant innovation, the result of a partnership between the industry and operating authorities." (5) It appears that the French are committed to a major research effort to improve concrete pavement technology.

The selection of a concrete pavement is usually the result of a life-cycle cost analysis over a 25- to 30-year period. When concrete can be constructed with a local aggregate, it is usually cheaper than AC. However, limestone is not good for the surface, which should contain a harder aggregate.

"The pavement structures given in the catalogue of standard designs are equivalent and offer the same service life. However, the amount of maintenance needed to prevent premature aging of the structures and to guarantee satisfactory surface characteristics differs. One of the advantages of concrete pavements is that they require very little maintenance. This is why an economic comparison of pavement structures must also look at the global investment cost including maintenance."(10)

In designing new concrete pavement today, the French would usually put SMA or a surface treatment on the surface to improve friction and smoothness, although the exposed aggregate surface is favored by many. There is very little snow in the Paris area, which is why SMA or porous asphalt does not get bladed off. Also, the two-layer pavement with the exposed aggregate surface is performing well.

The engineering philosophy of the French toll roads is very impressive with regard to their efforts to provide the highest quality of service to users. The excellent quality of their pavements speaks for itself.

It was stated at the Nantes LCPC research laboratory that a long life (more than 30 years) is expected from concrete pavements for two reasons: mechanical resistance to traffic (no rutting and control of fatigue damage) and ability to resist environmental problems. Truck traffic is expected to continue to increase greatly in France.

• France References

1. Bonnot J. "Concrete Pavements, Introductory Presentation," Compilation of Technical Reports on Concrete Pavements in France, Laboratoire Central des Ponts et Chaussées (LCPC), Paris, France, 1990.
2. Christory, J. P., "Overview and Recent Developments in Concrete Pavements in France," paper presented at the 1991 Annual Meeting of the Transportation Research Board, Washington, D. C., 1991.
3. Charonnat, Y., J. Augoyard, and L. Ponsart, "Concrete Pavements, A New Process for the Laying of Monolithic Composite CRC Pavements," Compilation of Technical Reports on Concrete Pavements in France, Laboratoire Central des Ponts et Chaussées (LCPC), Paris, France, 1990.
4. Aunis, J. H., "CRCP on the French Motorway," 6th Conference: Road Engineering Association of Asia and Australia, (SAPRR Autoroute, France) March 1990.
5. Chauchot, J. "Concrete Pavements, Foreword," Compilation of Technical Reports on Concrete Pavements in France, Laboratoire Central des Ponts et Chaussées (LCPC), Paris, France, 1990.
6. Deterne, J. "Concrete Pavements, Rebuilding of the Special Slow-Vehicles Lane of the A6 Motorway on the Bessey-en-Chaume pass Using CRCP," Compilation of Technical Reports on Concrete Pavements in France, Laboratoire Central des Ponts et Chaussées (LCPC), Paris, France, 1990.
7. Charonnat, Y., J. Chauchot and A. Sinton, "Concrete Pavements, Cement Concrete Overlays on Flexible Pavements in France," Compilation of Technical Reports on Concrete Pavements in France, Laboratoire Central des Ponts et Chaussées (LCPC), Paris, France, 1990.
8. The LCPC/Freyssinet Connector, 52/54 Rue de la Belle Feuille, 92100 Boulogne-Billancourt, France.
9. Charonnat, Y. and A. Marsot, "Concrete Pavements, the Recycling of Cement Concrete," Compilation of Technical Reports on Concrete Pavements in France, Laboratoire Central des Ponts et Chaussées (LCPC), Paris, France, 1990.
10. "FHWA DAY," Document prepared by the French Highway Administration and distributed to the US TECH Study Tour, 27 May 1992.

11. Balay, J.M., J.L. Nissoux, J. C. Gramsammer and A. Sainon, "Experimentation on Concrete Pavements at LCPC Fatigue Test Track," Paper provided to US TECH Study Tour at Nantes, France, May 1992.
12. Guinard, P. J. L. Nissoux and P. Orsat, "Concrete Pavement Restoration: French Maintenance Strategy and Load Transfer Device," Transportation Research Record No. 1183, Transportation Research Board, 1988.



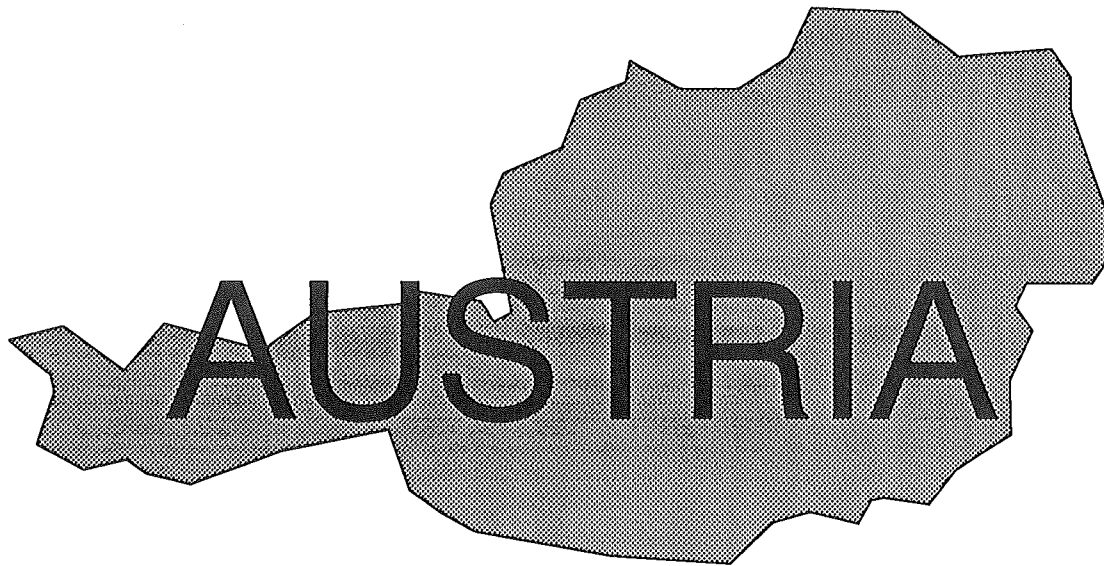

### 3.2 Austria

#### • Concrete Pavements in Austria

Austria began constructing concrete pavements in the 1940's and has constructed both JPCP and JRCP.

Today many pavements older than 30 years and some 50 years old exist in Austria. The following table shows the extent of concrete pavements on Austria's main highways.

Table 3.1 Austrian highway mileage.

Pavement Type	km	Percentage
Asphalt concrete	834	54
Concrete	698	46
Total	1532	100

1 km = 0.621 mi

However, studded tires caused ruts of 2 to 3 mm (0.08 to 0.12 in) in the older pavements. Because Austria has a lot of rain some type of rehabilitation had to be performed. A thin polymerized asphalt layer has been placed over the truck lanes of many older concrete pavements to repair the studded tire damage. This layer has a life of only four to six years.

#### • Designs

Austria has developed a catalog of pavement designs for a 30-year period. Four different designs are considered: dowelled and undowelled with untreated granular base or cement-treated base. Ranges of current design thickness are as follows.

✓ 18-22 cm (7-9 in) JPCP (25 cm (10 in) for heavy traffic)

✓ 5 cm (2-in) AC interlayer

✓ 20-45 cm (8-18 in) untreated granular layer with less than 3 percent fines

✓ 18-22 cm (7-9 in) JPCP

✓ 5 cm (2 in) interlayer AC

✓ 18-20 mm (7-8 in) cement-treated base (only past five years)

The thickness values in the design catalog are based upon a minimum bearing capacity on the subgrade as determined by plate loading tests on site and defined as an acceptance limit in Austrian Specification RVS 8.24.

The minimum bearing value is 35 MPa (5075 psi). If the soil does not achieve this level of bearing, soil stabilization, soil replacement by better materials or other methods to achieve the bearing capacity is required. The minimum bearing capacity for asphalt and concrete pavements is the same. The frost depth in Austria is 1.5 m (4.9 ft).

The typical joint spacing is 6 m (20 ft) for a 25-cm (10-in) slab. Dowels are 2.6 cm (1 in) in diameter and 50 cm (20 in) in length. For heavier traffic, the maximum joint spacing, in meters, is  $25 T$ , where  $T$  is the slab thickness in millimeters. Thus, a maximum joint spacing for a 25-cm (10-in) slab is 6.25 m (20.5 ft).

Faulting of transverse joints is well controlled by dowels, which are essential. Austria found that dowels must be coated to prevent corrosion. On some early projects, dowels were not coated and corrosion was serious.

In the late 1970's, the sealing practice changed in some areas of the country. The initial saw cut for transverse and longitudinal joints was made 3 mm (0.12 in) wide and the joint was not sealed. This practice saved about 10 percent of the construction cost. There is controversy about this because some projects are sealed even today, and some feeling is that joint sealing would add life to the concrete pavement.

Included in the JPCP thickness is a 4-cm (1.6 in) top layer of smaller-sized hard aggregate that is used to provide a low-noise, high-friction texture. The surface aggregates are exposed during construction as described later. Structural design for pavements on bridge decks and in tunnels is also given in catalogs.

The full-width paving is 11.5 m (37.7 ft), and includes an inner lane and narrow shoulder of 4.75 m (15.6 ft), an outer lane of 3.75 m (12.3 ft) and a tied shoulder of 3.00 m (9.8 ft). The cross-slope of old pavements was 1.5 percent, but now all new pavements have 2.5 percent slope.

- **Rehabilitation**

Austria has tried several different ways to rehabilitate their concrete pavements. A few projects have been cracked and sealed and overlaid with AC. An unbonded concrete overlay was recently placed on an old pavement with a 5-cm (2-in) AC separation layer. Its performance was very good, but it was found that it was more economical to recycle all pavement materials and reconstruct the pavement into either concrete or asphalt.

For rehabilitation projects, all site materials were recycled back into the rehabilitated pavement. Old concrete is recycled into a new concrete slab. Old aggregate base is used as part of a new cement-treated base. Old AC is crushed, some is used in new recycled concrete, and the remainder is used in the 5-cm (2-in) AC interlayer between the slab and cement-treated base.

See the project site description below for details of some rehabilitation projects.

- **Noise Pollution**

Increased sensitivity of Austrians with regard to traffic noise has resulted in a major noise-reducing efforts over the past decade through use of noise barriers, low-noise freight vehicles, and new low-noise pavement surfacings. Several surfacing techniques have been evaluated in Austria.

Porous asphalt surfacing was first constructed in Austria in 1984 and a lot has been constructed since that time. Measurements have shown that this surfacing initially reduces tire noise emission by 4 to 6 dB(A) at 100 km/hr (62 mi/hr) compared to conventional asphalt or concrete pavements, respectively. The porous surface also reduces hydroplaning and splash during rainstorms. However, problems have developed with this surfacing. Older porous asphalt surfaces have shown a significant decline in the noise-reducing effect due to the voids filling up with soil and abrasives and further compaction. (4) Porous asphalt would therefore need to be cleaned

over time to maintain its low-noise characteristics. Another concern is that deicing salt requirement is about 15 to 50 percent higher to prevent icing. Even then icing cannot be prevented completely under critical weather conditions, such as freezing rain. (4, 6)

The use of slipform pavers with a super-smoother flattens any transverse waves reduced noise by 2 dB(A). Further improvements by 1 to 2 dB(A) were achieved by creating a fine-rough longitudinal texture using a burlap drag, instead of the formerly common transverse brushing with a broom. (4) The burlap drag is simple and inexpensive, but friction resistance is lower than with a transverse broom finish. Higher friction resistance can be obtained but the concrete must be rich in mortar and longitudinal grooves 2 mm (0.08 in) deep must be made using a plastic brush or metal tines. (6)

The exposed aggregate technique is similar to that described in Belgium. The main difference is that in Austria the slab is placed in two layers so that the top layer can contain a high quality, smaller aggregate (maximum size 7-8 mm (0.27-0.31 in)) to maximize noise reduction. The two-layer method is used in Austria because the aggregates that are resistant to wear and polishing are expensive. This technique was first constructed in Austria in 1990 with another four sites in 1991. This technique reduces noise emission through provision of a textured surface with selected hard aggregates in the upper 4 cm (1.6 in) of the slab, as shown in Figure 2.8. The surface is sprayed with a retarder, covered with plastic sheeting to

prevent evaporation and the fine mortar on the surface is removed by brushing the next day, or a combination of a retarder/curing compound is used. (6)

Optimum noise reduction requires that the maximum aggregate size should be 7-8 mm (0.27-0.31 in) and the percent of particles 4-7 mm (0.16-0.27 in) or 4-8 mm (0.16-0.31 in) should be as high as possible, but there must be enough mortar between the particles to ensure excellent bond. The w/c ratio should be well below 0.40 and texture depth should not exceed 1.2 mm (0.05 in). The stone particles must consist of a wear- and friction-resistant material. In Austria, a 4-cm (1.6-in) top layer is constructed with the aggregates containing the above characteristics.

Figure 2.16 shows the beneficial effect of the exposed aggregate surface on noise emission reduction of as much as 7 dB(A) from that of old concrete. The exposed aggregate noise emissions are comparable to that of porous asphalt surfaces. Exposed aggregate is not likely to lose its noise-reducing properties as the porous asphalt does.

The exposed aggregate surface also provides a high level of friction resistance. (6)

During the trip along the A1 freeway from Vienna to Salzburg the Study Tour stopped at the beginning of a new concrete section with the exposed aggregate surface. This section was adjacent a section with a porous asphalt surface. There was no discernable difference in traffic noise between the two sections. Both were very quiet.

Some additional details are given under the A1 project site description.

- **Concrete Materials and Construction**

Concrete quality appeared to be excellent in Austria even though many freeze-thaw cycles occur and a lot of deicing salt is used. There are no reported occurrences of "D" cracking or ASR and only a few freeze-thaw durability problems. Cores from old concrete pavements have 100 MPa (14,500 psi) compressive strength.

All concrete mixes must be approved by an authorized and accredited laboratory.

Concrete compressive strength is specified to be more than 35 MPa (5075 psi) for the lower concrete layer and more than 40 MPa (5800 psi) for the top layer after curing for 28 days. The flexural strength must be 5.5 MPa (798 psi) for 12- by 12- by 36-cm (4.7- by 4.7- by 14-in) beams in center-point loading. Austria believes primarily in the flexural strength test for concrete pavements.

The air void bubble spacing must be less than 0.22 mm (0.0087 in) and total entrained air content must exceed 2.0 percent.

Whenever concrete slabs are removed for rehabilitation, they are recycled into concrete or some other use on the project site. The maximum particle size is 3.2 cm (1.25 in) and natural sand is added to the mix.

Laboratory tests have shown that particles from old concrete pavements are better than many natural aggregates. The recycled concrete was superior to normal concrete made from gravel. Coarse recycled concrete from 4 to 32 mm (0.16 to 1.25 in) is being used as the coarse aggregate, the particles finer than 4 mm (0.16 in) are used for mixing with the in situ subbase (prior to cement stabilization).

In addition, the crushed concrete particles may contain up to 20 percent AC particles (originating from existing AC overlays on the concrete pavement) without essentially impairing the quality of the new concrete. This technique has been used on three reconstruction sites of the A1 freeway although the percent of asphalt has been only 4 to 6 percent. Figure 3.5 shows a section of a concrete mixture containing AC material. This provides a more economical mixture and a way to reuse old AC material which is usually taken from thin AC overlays of concrete pavements. Extensive research on concrete recycling has been conducted by Dr. Sommer of the Research Institute of the Austrian Cement Maker's Association. (3)

- **Project Sites Observed**

One recently completed project and two under construction were observed by the Study Tour on the A1 freeway which connects Vienna with Salzburg. This 300-km (186-mi) highway is a heavily trafficked east-west highway. It was all constructed of JRCP over 20 years ago, and some of it is over 30 years old. (2)

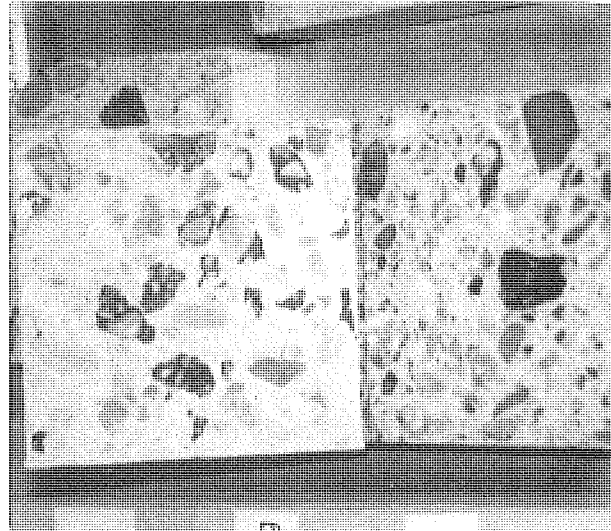

Figure 3.5 Cut section of an Austrian recycled concrete mixture containing old AC overlay material.

**A1 Freeway Unbonded Concrete Overlay.** The original 1957 JRCP had a 24-cm (9.5-in) slab and 3 cm (1.2 in) of sand over an aggregate base. The old slab was cracked and sealed, 5 cm (2 in) of AC was placed, and then a 20-cm (8-in) JPCP overlay was placed. (2)

**A1 Freeway Recycling and Reconstruction.** The original JRCP (some portions included a thin AC overlay) was shattered using a Wirtgen Guillotine, hauled to a crushing plant on site and processed into several fractions. These fractions contain between 2 and 10 percent AC from the thin AC surface which was included in the recycled concrete (about 6 percent average was old AC material). The 0- to 3-mm (0- to 0.12-in) fine fraction was placed on top of the old gravel subbase which contained 15 percent

finer and the material was then stabilized in-place to a depth of 20-25 cm (8-10 in) with cement using a Bomag machine. The compressive strength requirement was 3 MPa (435 psi) at 7 days. A 5-cm (2-in) AC layer (which included some recycled asphalt pavement) was placed on top of the cement-stabilized layer to provide the concrete pavement with an erosion-resistant base. (3)

A JPCP 25 cm (10 in) thick with dowelled joints spaced at 5.5 m (18 ft) was placed using a slipform paver. Plastic-coated dowel bars, 26 mm (1 in) in diameter and 50 cm (20 in) long, were spaced at variable locations, 11 in the truck lane, 7 in the passing lane and 4 in the shoulder. The contraction joints were sawn 3 mm wide and left

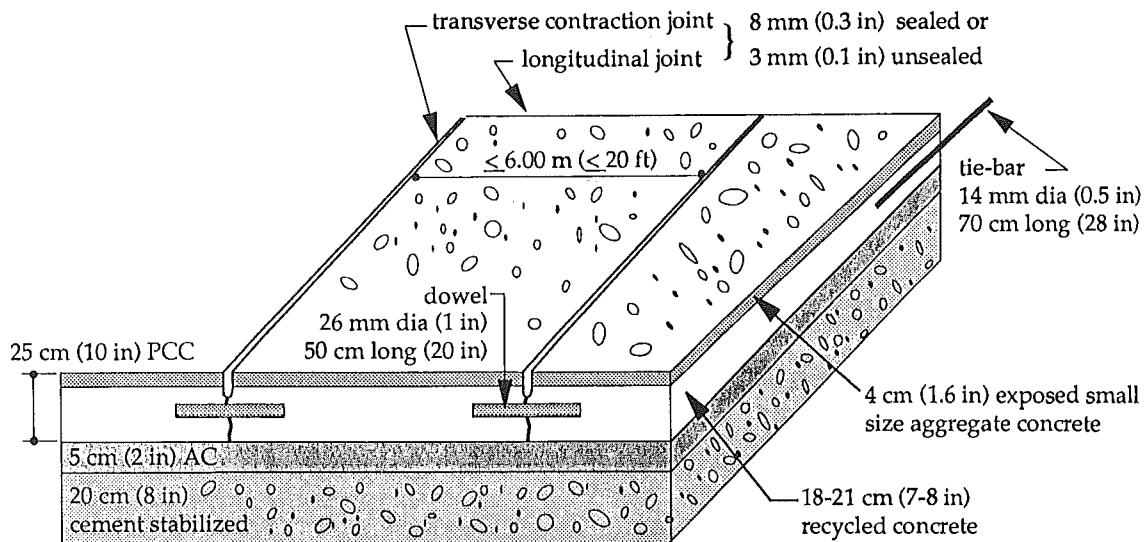

Figure 3.6 Cross-section of Austrian JPCP reconstruction on the A1.

unfilled on this project. Note that on some projects the joints are sawn 8 mm (0.3 in) wide and sealed with a bituminous filler. Paving width was 11.5 m (38 ft). (3) Figure 3.6 shows a cross-section of the completed pavement.

The slab was designed to have two layers: a bottom layer of recycled concrete and a top layer with high-quality hard aggregate (called chippings) to provide a low-noise, high friction surface. The slab was placed in two layers by a single modified "double-decker" Wirtgen slipform paver. This paver placed two separate layers of slipformed concrete "wet-on-wet" to form a monolithic structure. (5) The Wirtgen SP1600 slipform paver with the integrated two-layer paving kit performed the following operations:

#### Bottom Layer (21 cm (8.5 in)):

- ✓ Spread the top layer concrete over full width (11.5 m (38 ft)),
- ✓ Liquify and compact the bottom layer,
- ✓ Form the bottom layer by extrusion,
- ✓ Insert the dowel bars at transverse joints,
- ✓ Insert the tie-bars on longitudinal joints, and
- ✓ Restore the surface of the bottom concrete slab after insertion of dowels and tie bars with the first oscillating beam.

#### Top Layer (4 cm (1.6 in)):

- ✓ Convey top layer concrete from truck mixer over the paver main frame and discharge into a hopper feeding in the spreading augers,

- ✓ Liquify and compact the second layer with a high-frequency vibration system (vibration is controlled in frequency to avoid causing additional vibration to the bottom layer),
- ✓ Form the top layer by extrusion, and
- ✓ Finish the top layer with a second oscillating beam and the super smoother.

The 21-cm (8.5-in) bottom layer contained the recycled crushed concrete plus natural sand. Cement content was about  $360 \text{ kg/m}^3$  (607 pounds/yd<sup>3</sup>) and also contained entrained air (3.5 percent). The flexural strength at 28 days ranged from 6.5 to 9.5 MPa (942 to 1378 psi) with a mean of 7.75 MPa (1124 psi).

The top 4-cm (1.6-in) layer contained a high percentage (65 percent) of hard stone chippings having a maximum size of 8 mm (0.3 in) and about 35 percent sand (0-1 mm (0-0.04 in)). Cement content was  $450 \text{ kg/m}^3$  (758 pounds/yd<sup>3</sup>). The mixture had air entrainment (4 percent), plasticizer, retarder and a water/cement ratio of 0.38 for durability and low shrinkage. A retarder was used for the top concrete to prevent it from stiffening more quickly than the bottom concrete. The stone chippings (4-8 mm (0.16-0.31 in)) had an LA abrasion value of less than 19 and a polished stone value greater than 50. The surface of the concrete was sprayed with a retarder and covered with a plastic sheeting or sprayed with a film-forming curing compound to prevent evaporation. The next day the surface was brushed to expose the chippings and sprayed with a curing compound. Texture depth was about 0.9 mm (0.035 in) by the sand patch measurement method.

A discussion of the noise characteristics of this surface was previously given. Smoothness specifications were applied using a profilometer. Joint sawing was done through the plastic sheeting.

The concrete crusher and plant that produces the lower recycled concrete layer was visited. Approximately 10 percent recycled AC is included in the concrete mixture. The specifications allow up to 20 percent but this requires too large a cement content to be economical. A separate plant mixes the top layer. Only recycled concrete is used for the coarse aggregate in the lower layer.

**A1 Freeway Salzburg Recycling and Reconstruction.** This 17-km (10.6-mi) project was nearly identical to the previous A1 freeway project. Truck traffic was heavy on this section (3500 per day). The original JRCP was overlaid with a thin AC overlay which was sawed and sealed. This layer was debonding from the slab and large pieces were coming off, which precipitated the rehabilitation. This project was to be completed in 26 weeks and the bonus per day and penalty per day were equal. The study tour observed the old concrete pavement removal process, which included slab fracturing and a large backhoe loading pieces of concrete into a truck. Figure 2.8 shows a photo of a core from this project. Figure 3.6 shows a cross section of the slab showing the recycled concrete base and the top surfacing for noise reduction. The westbound lanes, shown in Figure 3.7, had been completed the previous year.



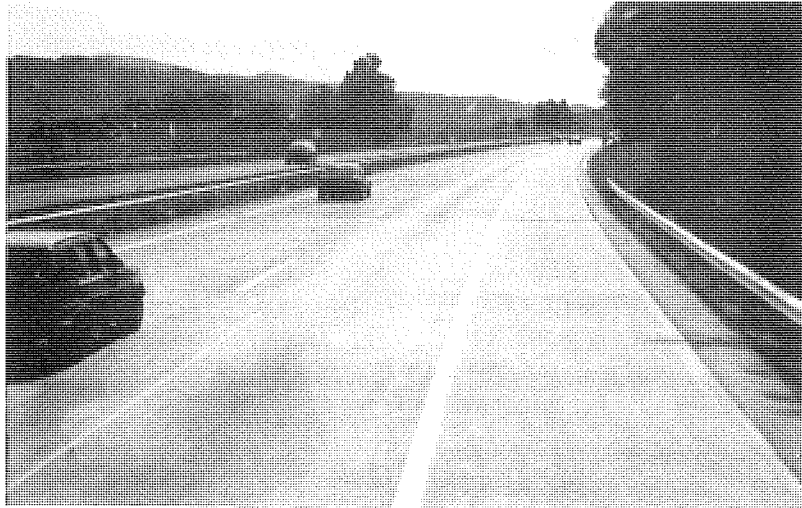

Figure 3.7 Photo of the A1 recycled concrete pavement near Salzburg, Austria.

- **Traffic Loadings**

The Austrian freeways carry heavy traffic loadings. The typical ADT is 25,000 (up to 100,000) with an average of 12 percent trucks. The growth rate in highway freight transport is high (7 percent per year). The single-axle load limit is 10 t (22,046 pounds) and the tandem-axle limit is 16 tons (35,300 pounds). A large number of overloads exist. Austria is likely to increase its legal axle weights to the 11.5 t (25,353 pounds) EC maximum for single axles.

Concrete pavements are designed for 30 years of traffic, taking into consideration different traffic lanes, distribution within traffic lane (from 0.6 for a lane more than 3.5 m (11.5 ft), to 0.9 for 3-3.5 m (10-11.5 ft), to 1.0 for a lane less than 3.0 m (10 ft)), the annual growth rate, and the design

period. Equivalency factors are used to calculated equivalent single-axles of a 10-ton (22,046 pounds) standard single-axle.

- **Summary for Austria**

Austria has constructed many jointed plain and reinforced concrete pavements since the 1950's which have performed very well under heavy truck traffic. Studded tire damage caused severe problems resulting in the requirement to place thin polymerized AC overlays on the truck lanes. The old pavements have excellent concrete durability.

The current design for new or reconstructed pavements is for short-jointed dowelled JPCP with tied concrete shoulders and a thin AC layer between the slab and the granular or

cement-treated base. Rehabilitation, including unbonded JPCP overlays on fractured slabs and AC overlays on fractured slabs, is underway on many old pavements. The most used technique to date has been the complete recycling of an old concrete pavement into a new concrete pavement with a full 11.5-m (38-ft) width.

There is a very strong emphasis on highway noise reduction in Austria. The use of the exposed aggregate surface in conjunction with the two-layer slabs (the top layer containing small hard aggregates) has shown significantly reduced noise levels and high friction.

Dr. Sommer of the Cement Research Institute stated that the level of effort needed to implement something (get it working) is greater than the original research effort. He believes that the researcher should guide the field implementation until the procedure is developed. This is an interesting concept which should develop a needed partnership between research and operations.

#### • Austrian References

1. Litzka, J. and G. Herbst, "A New Specification for the Structural Design of Pavements in Austria," Proceedings: 1986 International Conference on Bearing Capacity of Roads and Airfields, Plymouth, England.
2. Breyer, G., M. Fuchs, J. Litzka, A. Molenaar and G. Nievelt, "Survey of Reconstruction Methods of Worn-Out (Aged) Rigid Pavements," Technical Report, Federal Ministry of Economic Affairs, Austria, 1992.
3. Sommer, H., "Reconstruction Job-Sites 1991 on the Motorway Vienna-Salzburg Using Recycling and the Exposed Aggregate Technique," Technical Report, Cement Research Institute, Vienna, Austria, 1992.
4. Breyer, G. "Low-Noise Road Surfaces in Austria," Proceedings: International Tire-Road Noise Conference, Gothenburg, Sweden, 1990.
5. "Quiet Concrete," World Highways magazine, May/June 1992.
6. Sommer, H., "Noise Reducing Concrete Surfaces - State of the Art 1992," Results of a PIARC-Workshop held in Vienna 24-25 February 1992.



### 3.3 Germany

- Concrete Pavements in Germany

Germany has constructed many concrete pavements since the 1920's, mostly on the autobahn (freeway) system and at airports. Bus stops constructed of concrete were observed in Berlin. The Study Tour observed firsthand many original sections of the German autobahn system in the former east Germany constructed with concrete in the 1930's. Many of these original pavements are carrying heavy traffic today, although they are quite rough and many of them are under major rehabilitation. Fifty years of no

maintenance has left these pavements in deteriorated condition, and Germany is making a huge effort to rebuild all of these highways to link all areas of the country, which they feel is vital to their economic growth.

A photograph of a 50-year-old (1930's) jointed concrete pavement section on the autobahn approaching Berlin from Munich is shown in Figure 3.8. These were the divided controlled-access highways that impressed many Americans returning from World War II, including President Eisenhower, to sponsor the development of the USA Interstate highway system.



Figure 3.8 Photo of a 1930's German autobahn concrete pavement near Berlin. (Note cracking in outer truck lane of the 12-m (39-ft) slabs.)

Approximately 30 percent of the former west German autobahn and 82 percent of the former east German autobahn are constructed with concrete pavement (approximately 4,168 km (2588 mi) of concrete out of 10,900 km (6769 mi) total). The West German pavements constructed prior to 1970 are jointed plain and jointed reinforced concrete, and only dowelled JPCP was constructed after 1970. Germany favors dowelled JPCP because of the extensive use of deicing salts and the potential for corrosion of reinforced pavements. Over the years, the design of the German concrete pavements has changed considerably; however, the current JPCP design has been built extensively since the early 1970's both as new pavement and as overlays of old concrete pavements.

An extensive research and development program has been underway in Germany for many years, at such institutions as the Federal Highway Research Institute (BAST) and the Munich Technical University to improve concrete pavement materials, construction and design. Many excellent technical articles can be found in the literature from this research.

Concrete pavements have also been constructed at airports in Germany. The Study Tour visited the new Munich II International Airport that was just opened in May, 1992. This airport was constructed with more than 2 million square meters (2.4 million square yards) of 36-cm (14.2 in) dowelled JPCP for runways, taxiways and aprons. For comparison, Dulles International Airport has 1.2 million square meters (1.4 million square yards) of 38.1-cm (15-in) undowelled JPCP.

## • Pavement Designs

**Original Autobahn Concrete Pavement Design.** The following information was obtained during a meeting of the Study Tour and German highway officials in Berlin and also from references 3 and 7.

Planning and initial construction of the German autobahn was started in the 1920's. The first German autobahn ideas were based on car-only highways, built in northern Italy by Piero Puricelli in the 1920's. (7) The first cross-section of a four-lane divided highway was created in 1926, the word "autobahn" first appeared in 1928 (7), and the design speed was 160 km/h (100 mph) in non-mountainous areas. These pavements were conceived as two lanes in one direction with 7.5-m (24.5-ft) pavement width. A policy statement on the principle of performance required of the construction industry and also on contract and procurement procedures was issued by Fritz Todt, Inspector General of the German Highway Administration, in 1933:

"It is not always the lowest bid which should be given preference. Quality is the most important criterion." (7)

A decision was made about that time to construct the autobahn highway network with concrete pavements. By 1940 approximately 4000 km (2480 mi) of four-lane divided autobahn highways were constructed. During the war years the government prohibited using steel for any purpose other than military. A concrete pavement research program was carried out in the 1930's with the

construction of many test sections. The general design evolved as follows, although there are some variations of this design.

**Slab:** Uniform thickness, 20-25 cm (8-10 in) JPCP (some thinner and thicker), mostly two-layer construction. Top slab layer is 9 cm (3.5 in) thick and contains high-quality aggregate (3-cm (1.2-in) maximum size). The lower slab layer is 13 cm (5 in) thick and contains local gravel aggregates (5-cm (2-in) maximum size).

Width of traffic lane = 3.75 m (12.3 ft)  
(two lanes in one direction)

**Joints:** Spacing for plain jointed concrete sections = 8-12 m (26.5-39 ft)

Spacing for jointed reinforced sections = 12-30 m (39-98 ft) (stopped in 1937)

Typical expansion joint spacing 12-18 m (39-59 ft). (Note: It was common practice to systematically increase the joint spacing from slab to slab in increments of 1 m (3.3 ft) or so, with periodic return to the first spacing.)

Dowels 35.6 cm (14 in) long, 2.2-cm (0.875 in) diameter round steel dowels with a sleeve on one end.

Dowels spaced 30.5 cm (12 in) near center of slab with closer spacing toward edge.

Longitudinal joints tied (3.75-m (12.3-ft) lane width).

**Concrete:** Most pavements were constructed in two courses for ease in compaction of very dry concrete and to

use different quality aggregates in each layer. The upper layer used only high-quality aggregate as judged by compressive strength and wear tests (typical types were granite, basalt and quartzite) and the elimination of impurities and flat particles. A somewhat inferior aggregate (local gravel) was used for the lower layer for economic reasons.

Aggregate gradation was closely controlled through use of several size requirements. It appears that a fairly uniform dense aggregate gradation resulted from this specification.

Flexural strength requirements included 3.7 MPa (540 psi) minimum and 4.4 MPa (640 psi) average. Compressive strength requirements were 32 MPa (4,700 psi) minimum and 39 MPa (5700 psi) average. Strengths were tested with specimens made during construction and by means of tests on cores made at approximately 60 days. (3)

Very dry (zero-slump) concrete with a water/cement ratio usually of 0.45 or less. No air entrainment admixture was used.

#### **Foundation:**

Considerable effort made to reduce the damaging effects of frost heave and excess moisture. This was done by placing longitudinal drains to intercept ground water flowing towards the highway or to lower the ground water table, and by placing layers of granular materials (often sand was used)

between the slab and the subgrade. Often the grade line was raised 0.9 m (3 ft) or more above the natural ground level, and in cuts the roadway was excavated below grade and backfilled with selected material. (3) In the Berlin area, the concrete pavement was often placed on the sand subgrade.

**Shoulders:** Usually 0.38 m (1.25 ft) wide inner (left) and 2.2 m (7.33 ft) wide outer (right). Pavement included 17.8 cm (7 in) of concrete capped with 7.6 cm (3 in) of AC for color delineation. In cases where dark-colored concrete was used in the traffic lanes, plain concrete was used in the top course of the paved shoulder strip for color delineation. (3)

**Construction:** Usually two lanes formed at same time with a tied weakened-plane longitudinal joint. The concrete base for the shoulder strip was constructed before the pavement slab and was used as a base upon which to mount the rails carrying the heavy construction equipment used in the mixing, placing, and finishing operations. Tamping and some vibration of the concrete was performed. (3)

All placing, finishing, and preliminary curing operations were completed under sunshades that spanned the entire pavement. Woven-reed curing mats were left in place for 3 weeks and were kept continuously wet during that period.

Surfaces were dense and compact, with the coarse aggregate either just below the top or actually exposed to some degree. No thick layer of mortar exists. (3)

Many original sections of the German autobahn are still in place and serving heavy traffic in the former East Germany, whereas the former West Germany has previously rehabilitated most of the old pavements. The Study Tour had the unique opportunity to observe many of these old pavements during the trip from Munich to Berlin and also on the freeway loop surrounding Berlin (Berliner Ring). They are fairly rough, due mainly to the many transverse cracks that have spalled and faulted. No obvious pumping was observed and the 50-year-old concrete showed no durability problems. A large reconstruction effort is currently underway in the former East Germany and the concrete from these pavements is being recycled into either lean concrete base or the upper layer of the granular blanket.

During the visit to a reconstruction site on the A10, described below, a piece of old concrete pavement was obtained and submitted to the Construction Technology Laboratories (CTL) for analysis. The official petrographic analysis is given in the Appendix and a summary is provided here.

1. The sample is a hard, dense, good-quality concrete consisting of siliceous and calcareous aggregates in a portland cement paste. The paste-aggregate bond is tight and the concrete fractures through coarse and fine aggregate particles.
2. Estimated water-cement ratio, based on paste properties, is less than 0.35. Large residual cement particles (unhydrated portland cement clinker, UPC's) are abundant.

3. The concrete is not air entrained. Estimated air content is 1 to 2 percent. Most air voids are small and lined or filled with secondary deposits, mostly ettringite.

Some reasons for the good performance of these pavements:

- ✓ Lower traffic loadings during early life,
- ✓ Relatively mild climate,
- ✓ Highly durable concrete (achieved by care in proportioning uniform gradation mixes; 3-cm (1.2-in) maximum size, high-quality, hard top-course aggregate; consolidation by vibration; dry mix with low water/cement ratio; 21-day water curing and protection from sun and wind with a cover; no deicing salts used for many years),
- ✓ Thick granular layer between slab and subgrade for frost protection and some bottom drainage (sometimes this layer included fine sand and was not adequate),
- ✓ Backfilling with select material of very soft soil,
- ✓ Ground water moisture control, and
- ✓ Dowelled joints.

The long joint spacing (12 m (39 ft) in the Berlin area and especially when steel mesh was not used) appears to be the only major deficiency noted for this design, and resulted in many transverse cracks that spalled and faulted in the truck lane.

**Current German Concrete Pavement Design.** Following World War II, the concrete pavement designs varied considerably between West and East Germany. Prior to 1970, the West German design included jointed wire mesh-reinforced pavement with a joint spacing of 7.5 to 10 m (24.5 to 33 ft), including expansion joints at 60- to 100-m (197- to 328-ft) spacing. (1) Due to various problems, this design was changed to a jointed plain concrete pavement beginning in 1970. (1) This design has been improved since that time, evolving into the current autobahn highway JPCP design cross-section shown in Figure 2.4. Some details of this design are as follows.

#### JPCP Slab:

22-26 cm (8.7-10.2 in) thick, depending on truck traffic volume in design lane (see design catalog, reference 2). Top 7-cm (2.8-in) layer contains high-quality crushed aggregate for freeze-thaw durability and friction. The w/c ratio for both layers must be equal.

0.5 m (1.6 ft) widening for both traffic lanes.

Full 11-m (36-ft) width paving thickness for future traffic control during rehabilitation (four lanes of traffic can be accommodated).

**Shoulder:** Tied concrete shoulders both lanes (avoids differential frost heave that occurred on AC shoulders). (1)

**Concrete:** Exceeding 5.5 MPa (798 psi) in center-point loading (about 10-15 percent greater than third-point loading).



**Base:** 15-cm (6-in) cement-treated or lean concrete, exceeding 9 MPa (1305 psi), usually about 12 MPa (1740 psi) compressive strength after three days of wet curing, base bonded to slab, joints (or notches) provided in base (35 percent thickness) just beneath joints in slab. (Figure 2.5)

Some use of 25-cm (10 in) cement-treated base with cement-stabilized subgrade.

10-cm (4-in) bitumen-treated base also used sometimes.

**Subbase:** Granular blanket, 30 to 90 cm (12-36 in) thick, depending on frost penetration and bearing capacity, less than 5 percent 0.063-mm (0.0025 in) fines allowed before compaction (less than 7 percent fines after compaction).

**Transverse Joint:** 5.0-m (16.5-ft) spacing.

2.5-cm-diameter (1 in) dowels, unevenly spaced across section as shown in Figure 2.7, plastic coating with thickness greater than 0.3 mm (0.012 in) covers the total length of dowels, no oil used.

Automatic dowel placement, no baskets.

Saw depth: 0.25-0.30 slab thickness.

Sealant: Compression seal.

**Longitudinal Joint:** Saw depth: 0.40-0.45 slab thickness.

**Tie:** Deformed 20-mm-diameter (0.8 in) steel tie bar, plastic coating with

thickness greater than 0.3 mm (0.012 in) covers center 20 cm (8 in).

**Spacing of ties:** three bars per 5 m (16.5 ft) of slab at centerline joint, five bars per 5 m (16.5 ft) of slab at lane/shoulder joint.

**Sealant:** Compression seal.

**Subdrainage:** Variations in subdrains have been used. The latest cross-section (Figure 2.4) shows a porous concrete layer beneath the shoulder that provides a flow channel to a longitudinal subdrain which then empties at regular intervals into a lateral pipe and finally into a larger longitudinal pipe. The system observed on the A10 project included catch basins at regular intervals that were connected to the longitudinal subdrain (and were extended vertically to the surface of the shoulder and a catch basin with a surface grate to collect surface water) as shown in Figure 3.9. These catch basins were connected to the deeper manhole which was connected to a longitudinal drain pipe.

**Porus concrete layer under shoulder:** a 15-cm (6-in) layer of porous concrete is being evaluated beneath the concrete shoulder to promote drainage of the treated base layer.

**Surface:** Textured by light longitudinal brush (burlap drag) to produce low-noise surface with some macrotexture. Hard aggregate provides friction.

**Cross slope:** 2.5 percent uniform across lanes.



**Figure 3.9** Construction site on the A10 south of Berlin showing catch basins at edge of slab that are connected to longitudinal pipe under the lean concrete base and connected to the manhole shown on the left.

**Bridge Ends:** End lug is placed more than 15 m (49 ft) from backwall of structure and then an AC surface over a CTB are placed to the backwall, as shown in Figure 3.10.

A four-year warranty system exists for concrete and asphalt pavements, during which the contractor is responsible for repair of any problems that develop.

The government relies on the warranty and on the contractor protecting his reputation if problems develop. A small amount of money is withheld until final acceptance at the end of the warranty period. If major problems develop, the project is not accepted and

the contractor is warned that further repairs may be needed. Originally this occurred more often; now it seldom occurs. If the project is not accepted it affects the contractor's reputation and it is considered in future contract awards. Since performance on previous contracts is considered in awards, the contractor's reputation is important.

The words "emergency lane" are used to describe the shoulder because these pavements are constructed to a full 11-m (36-ft) width so that during any future rehabilitation, four lanes of traffic can be carried on one side of the divided highway.

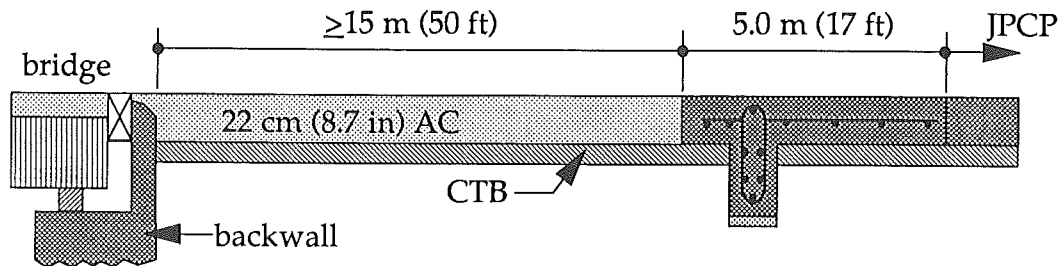

Figure 3.10 Bridge approach design for JPCP in Germany.

Projects constructed without dowel bars have faulted significantly. Many of these are in the former East Germany where the government prohibited dowels. Dowels are needed in the German climate and traffic to control faulting.

A plate load test in which pressure is repeatedly applied to and removed from the soil in stages is conducted in the field to ensure that a minimum bearing elastic modulus is achieved on top of the subgrade (minimum is 45 MPa (6,525 psi)) and on top of the granular blanket layer (minimum is 120 MPa (17,400 psi)) for concrete pavements. (8)

The German pavement design catalog is an excellent method to communicate the details of the pavement design to

the field. (2) There is now a new catalog for rehabilitation alternatives also. The Study Tour rode over several sections of the design and also observed a construction site. It was observed and reported from various sources that this design is performing very well under heavy traffic.

The catalog provides for a direct comparison between concrete and asphalt designs. The granular blanket is the same for both concrete and asphalt pavements to control frost heave, provide uniform support and to provide some bottom drainage. The AC pavement layers are built on top of this, as are the concrete base and slab.

The pavement design used for the new Munich II International Airport is given under the description of projects visited.

## • Concrete Material and Construction

An extensive research program was started in the 1930's into cements and concrete mixtures that included the construction of many test sections. A detailed description of the old 1930's autobahn concrete mixtures is given in reference 3. Reasons for the excellent durability of the old autobahn concrete are previously given.

Current German concrete requirements are as follows:

- ✓ 4 to 6 percent entrained air, including air void system requirements.
- ✓ Water/cement ratio < 0.42 to provide dense mixture.
- ✓ 340 kg/m<sup>3</sup> (573 pounds/yd<sup>3</sup>) cement.
- ✓ Mixing time is 45 seconds minimum.
- ✓ Graded aggregates.
- ✓ Aggregates must pass freeze-thaw and alkali-silica reaction tests.
- ✓ Freeze-thaw tests are run on aggregates for 300 cycles in aggressive solution and loss cannot 0.2 percent maximum.
- ✓ If reactive aggregates are present, low-alkali cement (less than 0.6 percent alkali) is specified. If problems still exist, the aggregate is changed.
- ✓ No flyash is used in highway pavement.
- ✓ Germany uses the center-point loading flexural beam test, which they found to be 10-15 percent higher than the third-point loading test. A minimum of 5.5 MPa (800 psi) for the center-point loading flexural strength at 28 days, which corresponds to about 4.9 MPa (711 psi) in third-point loading.

✓ Compressive strength is measured with a 3-cm cube. The minimum strength is 35 MPa (5075 psi).

✓ It was stated that some AC can be used in recycled concrete mixtures.

✓ Air void content and void system quality control are specified in reference 2. Tests are conducted the first day of production and again if there is any doubt as to air content. The bubble spacing must be less than 0.2 mm (0.008 in) and the micropores must be at least 1.8 percent.

The air void system may be tested in equipment viewed by the Study Tour at the Cement Research Facility in Dusseldorf. The equipment labelled "DBT" costs about \$20,000 and is manufactured by a Danish company. It relies on Bernoulli's principle that larger air bubbles, representing air voids, rise to the surface faster. A small tube sample, 2.5 cm (1 in) in diameter, of fresh concrete is taken from the newly placed slab, placed in the equipment, and the amount of air per time period is measured. This equipment can produce results in about 20 minutes on the air void content and spacing and can be used on the construction site. It reportedly correlates well with linear traverse results on hardened concrete.

Some ASR distress has recently developed on the northern Berliner Ring autobahn pavement due to high-alkali cement used on project (in the former East Germany). The East German government dictated the source of the aggregate and cement for this project. No "D" cracking problems

were observed, probably due to the use of only high-quality hard aggregates in the slab surface.

Various construction items:

✓ The use of a "tent" to protect the newly placed concrete from rain and sun may provide a significant effect. This procedure also would reduce the temperature and thermal gradient of the fresh concrete, which would reduce detrimental curling of the slab. This is still being done today as discussed under the Munich airport project description.

✓ Curing is done with either water sprinkling or wax-based curing compounds.

✓ The two-lift construction of the slab results in smoother profile as well as a more economical mixture where high-quality stone is expensive.

Cement-treated base compressive strength requirement is a minimum of 9 MPa (1305 psi) to provide resistance to erosion.

Germany believes strongly in bonding the lean concrete base or CTB to the slab to reduce curling and erosion. This is accomplished by notching the base 35 percent of its thickness immediately after placement exactly beneath the transverse and longitudinal joints of the concrete slab.

- Rehabilitation

A new rehabilitation catalog is available. Selection of the

rehabilitation alternative depends on the following criteria: (6)

- ✓ Traffic restrictions during reconstruction,
- ✓ Possibility of the use of recycled materials,
- ✓ Adequate clearance for bridges,
- ✓ Required improvements of cross-slope and other geometrics,
- ✓ Required widening of the cross section (lane or shoulder), and
- ✓ Economics.

The following types of rehabilitation are currently being performed on the German autobahn pavements. (6)

**JPCP Overlay with Interlayer:** The existing concrete pavement is fractured into pieces less than 0.5 m (1.6 in) in size. Then a 10-cm (4-in) interlayer of either lean concrete (notched) or AC material is placed on top of the existing concrete pavement. A JPCP overlay is then placed to the same thickness as a newly constructed pavement (i.e., 26 cm (10.2 in) for the heaviest traffic class).

**JPCP Overlay with Thick Fabric Interlayer:** The existing concrete pavement is fractured into pieces less than 0.5 m (1.6 ft) in size. Then a geotextile interlayer is placed on top of the existing concrete pavement. A slightly thicker JPCP overlay is then placed on top of the fabric (i.e., 27 cm (10.6 in) for the heaviest traffic class). The debonding with the underlying layer and the additional elasticity of the geotextile fabric requires a thicker slab. However, the softer fabric material may also reduce curling stresses in the JPCP overlay.

**Total Width Reconstruction:** The entire pavement is completely removed and a new JPCP with untreated crushed permeable base constructed. This pavement type is new for Germany; however, it makes it possible to recycle up to 100 percent of the old pavement. The JPCP thickness is increased (i.e., 30 cm (12 in) for the heaviest traffic class).

**Lane Reconstruction.** A cross-section is shown in Figure 2.10. A porous concrete base is recommended having a void content of more than 20 percent and compressive strength exceeding 15 MPa for a thickness of 40 cm (15.7 in). The permeability coefficient required for this base is less than  $10^{-6}$  m/s. The new JPCP is placed directly on this layer but is constructed thicker (i.e., 30 cm (12 in) for the heaviest traffic class). The new lane is tied securely to the adjacent slab by five corrosion-protected bars (2-cm-diameter (0.8 in)) per 5-m (16.5-ft) slab).

**AC Overlay:** A 12-cm (4.7-in) AC overlay is sometimes placed where a rehabilitation life of six to eight years is desired.

- **Noise Pollution**

A major concern about traffic noise exists in Germany as in other European countries. Until recently, most of the concrete pavements were textured with transverse tining, which was very good for friction and hydroplaning but caused considerable road noise and vibrations. It was found that this texture produced 3 dB(A) greater rolling noise than AC pavements and was not allowed to be used in urban areas. If, however, a longitudinal

burlap drag was used along with the smaller top-size aggregates, the noise level was about the same as a porous AC surface. This change was recently made in the construction specifications. Germany has experimented with various exposed aggregate surfaces but believes that the longitudinal burlap texture along with high-quality hard aggregates in the upper slab will provide low noise and good friction.

- **Project Sites Observed**

**New Munich II International Airport.** The Study Tour visited the newly opened airport and observed some of the 2 million square meters (2.4 million square yards) of concrete pavements as well as having a presentation on the construction of the pavements. Figure 3.11 shows a photo of a runway under construction. The JPCP constructed at Munich II Airport is defined as follows: (4, 5)

**Slab:** 36- to 40-cm (14.2- to 15.8-in) JPCP constructed in two layers. 40 cm (15.8 in) on ramps only.

Top 14 cm (5.5 in) includes crushed granite for better freeze-thaw resistance and friction.

Bottom 22-24 cm (8.7-9.5 in) used local gravel aggregate.

Double course construction was achieved in a single pass of a slipform paver in 15 m (49 ft) width.

Runway cross-section varied, with central 30 m (98 ft) being 36 cm (14.2 in) and outer 15 m (49 ft) on each side thinning to 26 cm (10.2 in). The total width is 60 m (197 ft).

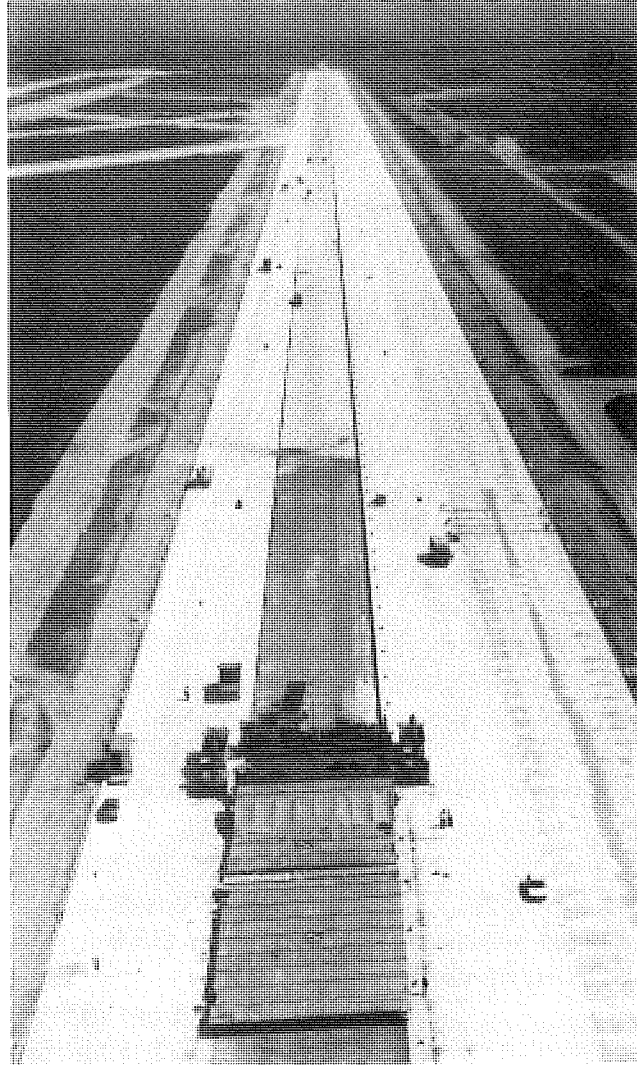

Figure 3.11 Photo of runway under construction at the new Munich International Airport. (Note the "tent" coverings placed behind the paver to provide curing protection to the surface for seven days.)

Dowels and tie bars were placed on top of the lower layer.

**Concrete:** Contractor subcontracts to testing lab that produces certified mix design.

Concrete strength for both layers was greater than 6 MPa (870 psi). Specifications required the mean of three center-point-loaded beams to be greater than 6 MPa (870 psi) at 28 days. Typically, the mean strength exceeded 7 MPa (1015 psi).

Continuous two drum plant used to achieve production of 200 cubic meters (262 cubic yards) per hour.

Water/cement ratio = 0.40 to 0.45.

340 kg/m<sup>3</sup> (573 pounds/yd<sup>3</sup>) cement.

Air content measured once per hour in laboratory.

Cores were taken and density was measured (contractor specifies density).

Slab would be removed if strength or density deficiency existed.

Paving width = up to 15 m (49 ft) for three 5 m (16.5 ft) slabs.

**Joints:** 5 by 5 m (16.5 by 16.5 ft) square slabs, transverse joints dowelled, longitudinal joints tied and shaped with a sinusoidal vertical profile.

Dowels were placed automatically in all transverse joints.

Joints were sawed within 8 to 10 hours.

Tie bars were placed automatically in outer longitudinal joints.

Neoprene compression seals were used in joints.

**Base:** 20-cm (8-in) cement-treated base was constructed and immediately notched through about 35 percent of its thickness exactly beneath the joints in the concrete slab.

An attempt was made to bond cement-treated base to concrete slab through cleaning and wetting surface.

**Subbase:** A thick granular blanket was placed between the subgrade and the cement-treated base course.

**Curing:** The concrete was moist-cured for seven days under a "tent" as shown in Figure 3.11 and then curing compound was placed.

**Profile:** A high-speed profilometer was used to measure profile. Less than 3 mm (0.12 in) gap was permitted beneath a 4-m (13-ft) leveling beam.

**A10 Autobahn (Berliner Ring south of Berlin).** This project involved the complete reconstruction of a four-lane divided autobahn highway concrete pavement, originally constructed in 1939, into a new JPCP. The following items describe the design and construction.

**Traffic:** Traffic was routed on to one side where a 20-cm (8-in) unjointed lean concrete strip about 4-m-wide (13 ft) was added to the original slab so that four lanes of traffic could be carried on one side. The lean concrete is expected to last through the



eight-month construction duration and then be recycled with the old concrete. Very heavy truck traffic exists on this highway.

**Pavement:** The old concrete pavement was fractured with a drop hammer. Then a large back hoe was used to pick up large pieces and load onto trucks to haul to crusher. The concrete was crushed and sized into stockpiles.

**Slab:** 26-cm (10.3 in) JPCP constructed in two layers.

Top 7 cm (2.75 in) contains crushed granite for better freeze-thaw and friction.

Bottom 19 cm (7.5 in) contains local gravel aggregate.

Longitudinal burlap drag texture in the hard aggregate surface for low noise.

**Joints:** 5-m (16.4 ft) slabs, transverse joints dowelled, longitudinal joints tied.

Plastic-coated dowels were placed automatically in all transverse joints in a nonuniform pattern (clustered in wheel paths of the truck lane).

Compression seals were used in transverse and longitudinal joints.

**Reservoir saw-cutting:** after the first saw cut, an elastic band was placed to fill the narrow cut across the two traffic lanes, and a knot was tied in each end to keep the band tight. This was done to keep slurry from the second saw cut from flowing into crack and infiltrating the base and drainage filter.

The first saw cut was 6.5 cm (2.6 in) deep (one fourth of the slab thickness). Observation of a section of completed slab showed that all joint had cracked through at joints giving good uniformity of cracks. All joints were placed above notches in the lean concrete base.

**Shoulder:** Tied concrete shoulder on outer lane.

**Concrete:** Contractor subcontracts to testing lab that produces certified mix design.

Concrete flexural strength for both layers was greater than 5.5 MPa (798 psi) at 28 days (center-point loading).

Conventional paver was used for slipforming pavement. An unusual feature was "T" shape of the vibrators.

**Base:** 20-cm (7.9-in) lean concrete base slipformed.

Notched within 20 minutes to about 35 percent of its thickness exactly beneath the joints in the concrete slab as shown in Figure 2.5.

The goal is to bond the lean concrete to the concrete slab through cleaning and wetting the surface. The base is watered three to four times per day.

Dowels and tie bars were placed in the lower layer.

Lanes were widened 0.5 m (1.6 ft).

The slab has a 2.5 percent cross-slope for good drainage.



Figure 3.12 Thick granular blanket placed beneath lean concrete base in Germany.

**Subbase:** A granular layer exceeding 30 cm (11.8 in) was placed directly on the subgrade. Figure 3.12 shows the thick granular layer placed beneath the lean concrete base.

**Profile:** The new two-layer pavement rides very well.

**Subdrains:** The subdrainage system was detailed under the description of the current German cross-section.

- **Traffic Loadings**

Traffic loadings are very heavy today on the German autobahn. This network is only 1.7 percent of Germany's total highway length, but carries 27 percent of its traffic. A typical autobahn has an ADT of 40,000 with 25 percent heavy trucks. The

legal maximum single-axle load was 10 tons (22,000 pounds) up to 1989. Today it is 11.5 tons (25,300 pounds) and it will probably be 13 tons (28,700 pounds) in 1993. A large amount of truck traffic exists on both east-west and north-south autobahn in Germany.

- **Summary for Germany**

The performance of the post-1970 jointed plain concrete pavements in Germany can only be described as exceptionally good. There are very few problems with the current design and it is competing economically with asphalt pavement.

The reasons for the good performance include the following:

- ✓ Variably spaced doweled joints,
- ✓ Bonding of the concrete slab to the cement-treated base or lean concrete base to reduce erosion and pumping at the interface and to reduce curling,
- ✓ A high-quality base that is resistant to erosion,
- ✓ Good-quality aggregates in the concrete, especially in the surface,
- ✓ The thick granular layer above the subgrade,
- ✓ The concrete's resistance to freeze-thaw damage due to careful air void control during construction, and
- ✓ The two-pipe surface and subsurface drainage system.

A long pavement life with low maintenance is expected. JPCP has been built as new pavement and as overlays.

#### • German References

1. Eisenmann, J., D. Birmann and G. Leykauf, "Research Results on the Bond Between Cement Treated Subbases and Concrete Slabs," International Seminar on Drainage and Erodibility at the Concrete Slab-Subbase-Shoulder Interfaces, Paris, France, March, 1983.
2. Beton, StraBenbau und Trag-schichten, Bauberatung Zement, 1992. (Specifications for German pavements.)
3. Jackson, F. H. and H. Allen, "Concrete Pavements on the German Autobahn," Public Roads, Volume 25, No. 4, June 1948.
4. Zachlehner, A., "Presentation about the Construction of Concrete Pavements at the New Munich Airport," June 6, 1992, Munich, Germany.
5. Brochure on Construction of New Munich II Airport by Heilit+Woerner Bau-AG (the technical managers of the project), KlausenburgerstraBe 9, D-8000 Munchen 80, Germany.
6. Leykauf, G., "Design for Renewal of Old Concrete Pavements in Germany," paper provided to US TECH by Munich Technical University, Munich, 1992.

7. Reuter, Hans-Reinhard and Hans-Ulrich Gruschow, "History of Autobahn Construction," Paper provided to US TECH Study Tour, Brandenburg Office of Autobahns, Berlin, Germany, 1992 (translation from German).
8. Plate Load Test, Din 18134, June 1990 Edition, German Construction Industry Standards Committee, Beuth Verlag, Berlin.
9. "Richtlinien für die Standardisierung des Oberbaues von Verkehrsflächen," 1986 (German standards provided to US TECH Study Tour, 1992).
10. "Zusätzliche Technische Vertragsbedingungen und Richtlinien für Tragschichten im Straßenbau," 1986 (German standards provided to US TECH Study Tour, 1992).



### 3.4 The Netherlands

- Concrete Pavements in the Netherlands

Concrete pavements have been constructed in the Netherlands for many years, mostly in the southern portion of the country due to serious settlements in the northern portion. Concrete pavements have been built on provincial highways, freeways, and airports. Many bike paths were observed to be constructed of concrete. In addition, concrete block pavers have been used extensively in the Netherlands in urban areas.

The Study Tour observed several concrete pavements on both the freeway system and provincial highways located in the southern portions of the country. The oldest pavement observed was constructed in the 1950's. Many of these concrete pavements carry heavy traffic because the Netherlands has some key truck routes that carry cargo to and from the port cities to the rest of Europe.

These pavements are nearly all jointed plain concrete. A few sections of CRCP have been constructed lately on freeways. Many sections of prestressed concrete pavements also exist at Schiphol Airport near Amsterdam.

The major area of current concern with concrete pavements in the Netherlands is tire/pavement noise characteristics. Major laboratory and field studies are underway in the development of low-noise surfaces that also have adequate friction and service life.

The Netherlands utilizes concrete block paving (CBP) extensively. Nearly 20 million square meters (23.9 million square yards) of CBP are placed each year. CBP blocks were introduced in the early 1950's and are now used for a wide range of applications from domestic pavements to complicated industrial pavements. (4)

- Designs

**Freeways and Highways.** Some older JPCP have been constructed in the Netherlands. The Study Tour travelled over a section of badly faulted undowelled JPCP on a sand base (N270) that was constructed in the 1950's and loaded with heavy truck traffic. Dowels are required for transverse joints of JPCP in the Netherlands.

One district in the southern part of the Netherlands prefers concrete pavements, due to their low maintenance and long life, and has constructed many sections. The costs of concrete and asphalt pavements are about the same in this area. The two-lane, two-way provincial highways typically consist of a 21-cm (8.3-in) JPCP slab with dowels and lane widening on each edge (the paint strip is painted 20 cm (7.9 in) from each slab edge).

The Netherlands adopted the German JPCP design during the early 1980's. This design included slabs 20 to 22 cm (7.9 to 8.7 in) thick, variably spaced dowels in joints, 5-m (16.4 ft) joint spacing, 11 m (36.1 ft) total full pavement width (two lanes 3.5 m

(11.5 ft) wide, a 1 m (3.3 ft) inner shoulder and a 3 m (9.8 ft) outer shoulder. Currently, the slab thickness is 26 to 28 cm (10.3 to 11.0 in) and dowels closely spaced (25 cm (9.8 in)) in the wheelpaths.

Some CRCP on freeways was also constructed in 1990 with a porous AC surface for low noise and good friction. The CRCP is advantageous because there is no reflection cracking from transverse joints through the porous AC surface. Another CRCP is currently under construction at this time with both a porous AC surface and a porous concrete surface being placed.

The base for the freeway pavements is lean concrete over a sand subbase. The lean concrete contains recycled rubble from old concrete. Differing from the German design, the Netherlands does not make attempts to bond the slab to the lean concrete base and does not notch the base. However, it was stated that the slab bonds to the base anyway for 10 years or more. Some problems with reflection cracking were reported. The depth of the side ditches are about 1 m (3.3 ft) below the base. Joints are sealed to keep out incompressibles.

**Concrete Bicycle Paths.** The Study Tour also observed many concrete bike paths (JPCP with short joint spacing and no dowels). Bicycles are a major form of transportation in the Netherlands. The paths were used jointly by bikes and local farm equipment.

**Airport Prestressed Concrete Pavements.** The Schiphol Airport in Amsterdam, which opened in 1967, is one of the largest in the world and carries a large amount of heavy aircraft traffic. After a comprehensive study, the airport chose to build prestressed concrete pavements on runway ends, all aprons and hanger floors. Since the original construction, many additional prestressed concrete pavements have been built due to airport expansion, so that now some 700,000 square meters (837,000 square yards) of prestressed pavement exists at the airport. Many of these pavements are now 25 years old and have shown excellent performance with very low maintenance. (1)

The pavement design is 18 cm (7.1 in) of prestressed concrete pavement, 2 mm (0.08 in) asphalt sand, 60 cm (23.6 in) of soil cement, and 20 cm (7.9 in) of sand over a clay subgrade that is 4 m (13.1 ft) below sea level. Slabs are 7.5 m (24.6 ft) wide by 30 to 120 m (98 to 394 ft) long. The original prestressing consisted of high-strength steel bars placed in tubes and then grouted, laid in the longitudinal and transverse directions to form a grid. Improved methods have been used in later years. (1)

- **Noise Pollution**

The Netherlands has adopted legislation to decrease noise pollution. The law requires that a theoretical calculation be made of the noise level of a newly constructed highway before the road is opened to traffic.

Complaints have been received from residents in this densely populated country about the noise levels of conventional asphalt and concrete highway surfaces. Thus, extensive research efforts have been devoted to develop surfaces to reduce the noise level.

Noise is generated by the engines of vehicles and by the contact between the tire and pavement surface. Policy is directed to limiting the noise emission at these sources and to reducing the noise level by means of measures like barriers or embankments. Texture is the major factor of concern in controlling tire/pavement noise emission. (2) The following treatments are under evaluation.

**Surface Layer of Porous Asphalt/Aggregate Mixture.** A thin layer (4 cm (1.6 in)) of porous asphalt has been determined to reduce the noise level by over 3 dB(A) relative to dense AC on the A2 freeway at Weert (see details below). There is concern about the durability of a porous AC layer on a concrete pavement, especially with regard to deterioration from reflection cracking. Some sections have been sawed and sealed with reportedly good results. The mild winters in the Netherlands prevent problems with icing of the permeable layer.

**Surface Layer of Porous Concrete.** At least three field sites have been constructed with a porous concrete layer of 3 to 10 cm (1.2 to 3.9 in) thickness. A polymer additive (more

than 10 percent by weight of cement) is needed to obtain frost and salt resistance and a sufficiently high flexural strength. Durability depends on the polymer content. The porous surface allows some of the air compressed under the tire to escape through the voids in the road surface, reducing the roadside noise. A 4 cm (1.6 in) layer having gap-graded aggregate with 25 percent voids produce the most noise reduction (see details below for A2 Weert site). For new construction, the porous concrete surface is placed two to three hours after the slab is placed. It is cured by covering it with plastic sheeting.

**Surface Layer of Exposed Dense Concrete.** The surface is exposed during construction using the same technique as in Belgium. Different aggregate gradations were tested with similar noise reductions. (2) The washed concrete noise level was comparable to dense AC and less than the conventional transverse brushed concrete surface.

**Surface Layer of Epoxy/Fine Grained Aggregate.** An epoxy resin binder was applied to a hardened concrete surface followed by a layer of crushed 3- to 4-mm (1.2- to 1.6-in) chromium ore slag (brand name Durop) and the surface was then rolled to produce a mosaic-like structure. The Durop surface treatment gave a noise reduction of 6 to 7 dB(A) relative to the original brushed concrete surface. This treatment is comparable to porous asphalt. (2)



**Surface Texture By Diamond Grinding.** This was performed on the A28 freeway and showed a reduction of over 3 dB(A) compared to the original transverse brushed concrete finish. However, this did not quite meet the requirements by 1 dB(A). (5)

- **Project Sites Observed**  
(All located near Eindhoven)

**A2 Freeway, Weert.** This site consists of an original JPCP resurfaced with a 4-cm (1.6-in) porous asphalt and 3 cm (1.2-in) porous concrete to reduce noise levels. The Study Tour visit occurred during a rainstorm and a major difference in splash between a nearby dense AC overlay and the porous asphalt or porous concrete was significant. Both the porous asphalt and the porous concrete gave a very smooth and quiet ride. Figure 2.14 shows the surface of the porous concrete. Standing on the roadside of the porous concrete or asphalt surface shows that noise created from the passing heavy traffic is definitely less than the noise level near the dense AC surface.

Reflection cracks from the longitudinal and transverse joints in the JPCP were coming through the porous asphalt surface and starting to spall. The porous concrete was sawed directly over the joints in the JPCP and were not spalling.

Compared to the dense AC surface, the porous asphalt surface gave a reduction in the noise emission level of

3.1 dB(A). The porous concrete gave a noise reduction of 2.0 dB(A). It was stated that the porous concrete would have given a greater noise reduction if its thickness was 4 cm (1.6 in) instead of 3 cm (1.2 in) and various construction problems (low workability) could be avoided. (2) A major problem with the porous asphalt or concrete surfaces is that they fill up with loose material and thus their sound-absorbing characteristics decrease within a few years.

**N266 Highway, Uden and N279 Highway By-Pass Helmond.** Several test sections were observed having exposed aggregate surfaces. The surface of one exposed aggregate surface is shown in Figure 3.13. Noise measurements show that the exposed aggregate surfaces produce a noise level comparable to a dense AC surface for passenger cars only. For traffic with 20 percent trucks, exposed concrete surfaces gave a noise emission level of 2.5 dB(A) greater than dense AC.

- **Traffic Loadings**

The legal single-axle load in the Netherlands is 10 t (22,000 pounds) which is expected to increase to 11.5 t (25,300 pounds) or greater in 1993 with the rest of the European Community. A considerable number of overloads occur on the highway system.

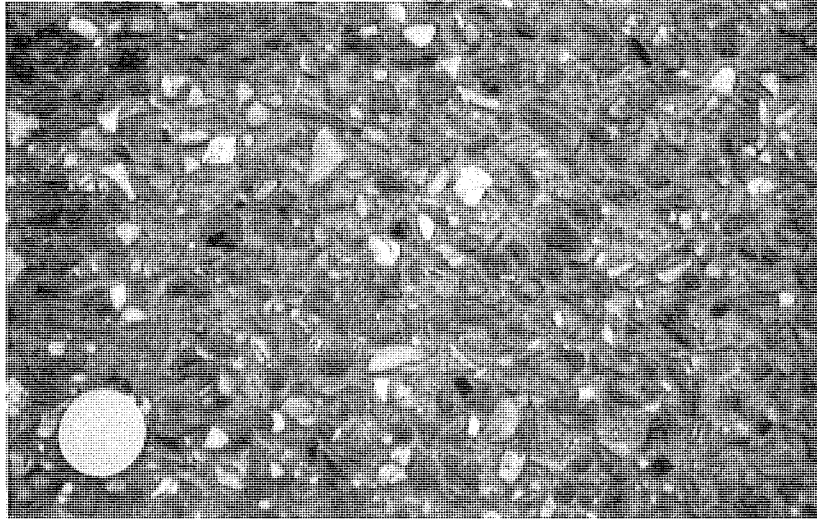

Figure 3.13 Exposed aggregate surface in the Netherlands.

- **Summary for the Netherlands**

Concrete pavements in the Netherlands are currently being constructed in greater quantities than before. The main problem that developed in the 1950's was joint faulting as a result of not using dowels. The adoption of the German dowelled JPCP design eliminated this problem and has produced low-maintenance long-term performance. There is a strong willingness to try new ideas in the Netherlands.

The main concrete pavement concern now is reducing tire/pavement noise. Considerable research is underway and several techniques are under evaluation. It was stated that either the porous (polymer) concrete surface or the epoxy/aggregate surface

treatment could produce noise levels comparable to that achieved by porous asphalt. (2) Experiments have shown that it is possible to obtain a surface layer of porous concrete which meets the requirements of noise absorption, durability and strength, but further research is needed. (2)

- **Netherlands References**

1. van Noortwijk, H. and A. V. D.Meent, "The Application of Prestressed Concrete to the Construction of Airfield Pavement," Proceedings of Second International Conference on Design of Concrete Pavements, Purdue University, 1981.

2. Eerland, D. W., Th. S. Grob and H. J. C. M. Onstenk, "Developments in Noise Reduction of Concrete Roads in the Netherlands," provided to the US TECH Study Tour, 1992.
3. Onstenk, E., "Measurements of Noise, Texture and Skid Resistance," Interim Report Subtask 1.2, Institute For Materials and Environmental Research B. V., the Netherlands, March 1992.
4. van der Vlist, A. A., "Urban Concrete Block Paving in the Netherlands," Association of the Netherlands Cement Industry (VNC), the Netherlands, February 1992.
5. Veer, G. and C. L. Dolle, "Low-Noise Surfacing on Concrete Roads," paper provided the US TECH Study Tour, 1992.



### 3.5 Belgium

- Concrete Pavements in Belgium

Belgium has constructed concrete for many years. A 67-year-old jointed concrete pavement constructed in 1925 in south Brussels (Dreve-de-Lorraine) is still in good condition, as shown in Figure 3.14. Approximately 40 percent of freeways are constructed with concrete pavement (645 km (400 miles) out of 1631 km (1023 miles) total) which are mostly CRCP, but a lot of jointed plain concrete pavement exists also. For example, a 35-year-old dowelled jointed plain concrete pavement in good condition was driven over on the freeway between

Eindhoven and Brussels. The pavement had a 20-cm (7.9-in) concrete slab on 15 cm (5.9 in) of cement-treated sand and 15 cm (5.9 in) of untreated sand. Several sections of even older jointed concrete pavement were also observed during the tour. The Belgian government favors CRCP due to its low maintenance requirements and has built this pavement extensively since 1970 as new pavement and as overlays of old concrete and asphalt pavements.

Belgium is well known for its development and extensive use since the early 1980's of the exposed aggregate technique that provides reduced rolling noise and vehicle vibration levels but also a high-friction surface.



Figure 3.14 Dreve-de-Lorraine highway, Brussels, a 67-year-old jointed concrete pavement constructed in 1925 with no longitudinal joints.

- **Designs**

Both jointed plain (with dowels) and CRC pavements have been constructed. The original and current CRCP designs are as follows (1):

Item	Original (1970-1978)	Current (1979-1992)
CRC Slab	20 cm (7.9 in) (high strength)	Same
Reinforcement	0.85 percent	0.67 percent
Reinforcement Depth	6 cm (2.4 in)	9 cm (3.6 in)
AC Interlayer	6 cm (2.4 in)	***
Lean Concrete Base	20 cm (7.9 in)	Same
Granular Mat	20 cm (7.9 in) minimum	Same
Longitudinal Joint Depth	< 0.33 Slab	0.33 Slab

\*\*\* This layer was eliminated for several years but is now included.

Over 100 km (62 miles) of the original CRCP design was built on freeways which carry heavy trucks. It has shown exceptional performance: no punchouts have occurred over the past 20 years under very heavy traffic. One of these 20-year-old CRCPs is shown in Figure 3.15. This pavement has recently been diamond ground to reduce noise from the original harsh cross tining.

However, in about 1978, the pavements had very tight closely spaced cracks (crack spacing was 0.5 m (1.6 ft)), and the government became concerned that the pavement would break up. On subsequent projects the reinforcement was reduced to 0.67 percent and the AC interlayer was eliminated, which resulted in a larger crack spacing. Some of these newer pavements are starting to show crack spalling and a few punchouts. Typical crack spacings are as follows.



Figure 3.15 20-year-old CRCP in Belgium containing 0.85 percent reinforcement, AC interlayer, lean concrete base and a granular subbase. (Note that a portion was diamond ground to reduce noise emission of the original transverse tining).

Construction Season	Percent Reinforcement	Mean Crack Spacing, m (ft)
Summer	0.85 (original)	0.40 (1.31)
	0.67 (newer w/o AC)	1.00 (3.28)
Winter	0.85 (original)	0.75 (2.46)
	0.67 (newer w/o AC)	1.60 (5.25)

This close crack spacing for the 0.85 percent CRCP is also the result of the 6 cm (2.4 in) of AC interlayer tightly bonded to the CRCP for the original design. The bonding of the CRCP to the AC interlayer is believed by the Belgian engineers to provide a structural equivalent of 2 cm (0.8 in) of concrete.

At about the same time, the depth of steel was changed from 6 cm (2.4 in) to the 9-cm (3.6 in) depth used now because of some problems with construction. On a sunny day one may see the bar pattern due to an effect of vibration near the longitudinal bars: the concrete vibrates more under the bar, causing unevenness of the surface. However, Belgium still believes that it is best to place steel above middepth to keep the cracks tight.

Several CRCP sections constructed since 1978 with no AC interlayer and 0.67 percent steel at a depth of 9 cm (3.6 in) have had larger crack spacings, wider cracks, erosion of the lean concrete base, and some punchouts.

When the shoulders include an AC surface with a granular base, water can drain laterally. However, when full-depth AC is placed as a shoulder, a bathtub exists and significant erosion occurs, followed by punchouts.

A corrosion study was recently conducted, in which cores at CRCP cracks were examined. Only minimal corrosion was observed, particularly for the original (0.85 percent steel) sections. The loss in cross-sectional area of reinforcing bars, as measured in the most severe cracks in the original

and current sections, does not exceed 5 percent for either design. (2)

#### • CRCP Overlays

A number of CRCP overlays have been placed on old concrete pavements and on old asphalt pavements. Performance of these overlays has generally been good.

#### • Concrete Material

The concrete has not contained air entraining agent. However, a high cement content (400 kg/m<sup>3</sup> (674 pounds/yd<sup>3</sup>)) produces a strong, dense concrete with a compressive strength minimum of 55 MPa (7,860 psi) and a mean of about 70 MPa (10,000 psi) at 90 days. The water/cement ratio is low, at 0.40 originally and 0.45 now. No freeze-thaw or any other durability problems exist and no joint deterioration problems exist. The high cement content helps reduce surface wear also.

Concrete pavements have been recycled back into lean concrete base, but not surface concrete because Belgium has an abundant supply of very good aggregates.

#### • Noise Pollution

A major concern about traffic noise exists in Belgium. This is largely due to the dense population, especially near highways. Between 1965 and 1975 a large amount of highway construction occurred in Belgium and most of the concrete pavements were textured by transverse coarse tining. This was very good for friction and hydroplaning but



caused considerable road noise and vibrations, which precipitated many complaints.

In 1980, Belgium began using an exposed aggregate technique which is described below for the E40 project. In Belgium, however, the slab is placed in one layer only with high-quality hard aggregate throughout, not in two layers as in Austria. This patented exposed aggregate technique has been used extensively and provides a durable surface that has about 4 dB(A) less rolling noise than cross tining. (Rolling noise is the noise produced by the contact of the tire with the pavement.) This is about the same rolling noise level as porous asphalt exhibits after one year (porous asphalt becomes clogged with fines and the noise level increases with time). Porous asphalt overlays of concrete pavements only last 5 to 10 years and then need to be replaced due to deterioration.

- **Project Sites Observed**

**E40 Freeway near Bierbeek.** Longitudinal diamond grinding was recently completed on this 20-year-old CRCP as a solution to noise caused by a fairly coarse surface transverse texture (6 mm (0.24 in) depth and 25 mm (1 in) spacing), as shown in Figure 3.15. About 4 to 6 mm (0.16 to 0.24 in) of surface was ground off and the bottom of the transverse tining was still present after grinding. This CRCP carries 63,000 ADT with 20 percent heavy trucks and is in excellent structural condition with no punchouts and close crack spacing. The measured rolling noise levels in dB(A) are shown below. The grinding reduced the noise level by an average of 4 dB(A).

Lane	Before Grinding	After Grinding
1	87.9-90.3	83.4-86.8 dB(A)
2	90.2-91.3	86.2-87.5 db(A)

The vibration level in the tour bus was significantly lower riding over the ground pavement than over the original cross-tined surface. Measured friction numbers increase significantly after grinding also.

**E40 Bertem Widening Construction Site (near the grinding site).** The existing 21-year-old, 20-cm (7.9 in) CRCP with 0.85 percent steel was being widened with an additional CRCP traffic lane. An added objective was to provide a low-noise surface texture.

✓ The low-noise surface texture was produced by chemically exposed aggregate. The slab is placed in one layer (the steel was placed on chairs) with the same aggregate throughout its depth (2 cm (0.8 in) maximum size). After the paver passes, the surface is immediately sprayed with a retarder which penetrates several millimeters into the mortar. A polyethylene sheet is then placed over the surface as shown in Figure 3.16. This serves to protect the retarder from the effects of inclement weather and to provide for curing when the retarded surface mortar is removed through special wire brushing after 24 to 72 hours.



Figure 3.16 Polyethylene sheeting placed over concrete surface after retarder has been sprayed (Robuco process). (4)

The surface aggregate is exposed to achieve the desired texture using a rotating brush shown in Figure 3.17. Either a sugar-based retarder which provides a 2 mm (0.8 in) texture (used on the E40 project), or a chemical retarder which provides a finer 1 mm (0.4 in) texture (as used in Austria) may be used. (4)

✓ The transverse steel reinforcement was skewed to avoid the potential for causing transverse cracks and has been standard for many years.

**E40 Freeway CRCP.** Traffic on this route is very heavy and similar to the E40 project at Bierbeek. This pavement is 20 years old. It has 0.85 percent steel at a depth of 6 cm (2.4 in), a 20-cm (7.9-in) CRC slab, 6 cm (2.4 in) of AC,

20 cm (7.9 in) of lean concrete and about 30 cm (11.8 in) of gravel. Cracks are spaced about 0.5 m (1.6 ft) and are very tight, with no failures. This project is an example of the original Belgian design that has provided excellent service.

**A12 Freeway CRCP Overlay.** This pavement is 12 years old. It has 0.67 percent steel at a depth of 9 cm (3.6 in), and a 20-cm (7.9 in) CRC slab placed over a badly rutted AC pavement. Cracks are spaced about 1 m (3.3 ft) apart and a few are spalling, with pumping and a few punchouts occurring.

**N45 Aalst Whitetopping with Fibrous Concrete.** This project has an ADT of 12,000 with 15 percent trucks.



Figure 3.17 Rotary brush removing thin surface layer of mortar to provide the exposed aggregate surface after polyethylene sheeting has been removed.

It consists of a 3-year-old thin steel-fiber-reinforced concrete overlay (30 kg/m<sup>3</sup> (50 pounds/yd<sup>3</sup>), 5 cm (2 in) long) placed over a badly rutted AC pavement. The overlay was 12 cm (4.7 in) thick with a 10-m (32.8-ft) undowelled joint spacing. A transverse joint is shown in Figure 3.18. The existing 22-cm (8.7-in) AC pavement was milled 12 cm (4.7 in) prior to placement of the 12-cm (4.7-in) fiberized concrete overlay. The pavement was in excellent condition.

Belgium has constructed over 130,000 square meters (155,500 square yards) of this type of overlay. This pavement has performed best when placed over existing AC pavement or when a 4.5- to 6-cm (1.8 to 2.4 in) layer of AC was placed over an existing concrete

pavement prior to the fibrous concrete. No cracking or other distress was observed. A 12-cm (4.7 in) thickness is considered a minimum for design and a 5 m (16.4 ft) joint spacing has worked the best. It was stated that there are actually few fibers at the surface (less than 1 percent) so that if they corrode it would not affect performance.

The design assumes that the fibrous overlay bonds to AC. Normal concrete overlays of AC pavement would be 18 cm: Belgium assumes that two thirds of this normal thickness may be used with steel fiber reinforcement. (3)

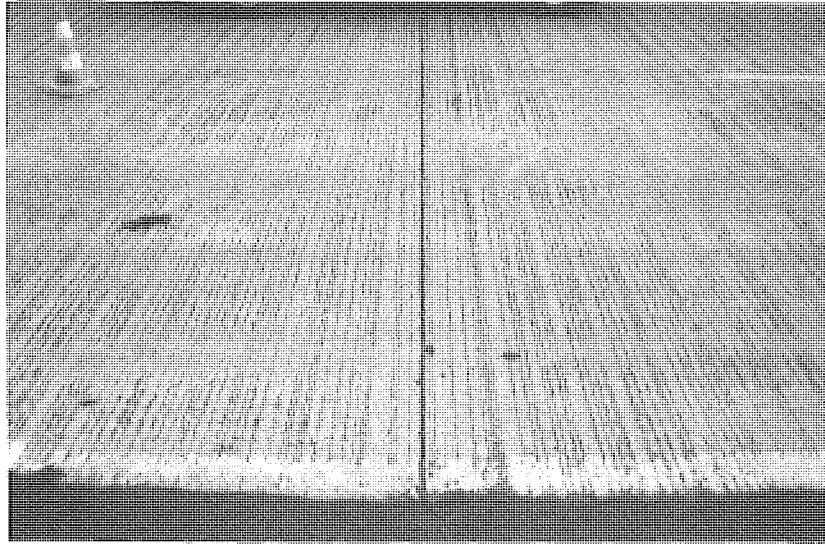

Figure 3.18 Surface and transverse tining of fiber-reinforced concrete overlay of an AC pavement in Belgium.

- Traffic Loadings

Traffic loadings in Belgium are very heavy. Figure 3.19 shows axle load distribution data for 1965 and 1991, obtained from Belgium. Note the heavy loads and the significant increase over time. The annual number of axles over the current U.S. limit of 8.9 t (20,000 pounds) is 13 percent. There is very little enforcement of load limits in Belgium.

- Summary for Belgium

The performance of concrete pavements in Belgium can only be described as exceptionally good, especially the original CRCP. The primary reasons include the following for the original design:

- ✓ The previously used 0.85 percent reinforcement placed 6 cm (2.4 in) from the top of the CRCP slab,
- ✓ High cement content ( $400 \text{ kg/m}^3$  (674 pounds/yd<sup>3</sup>)) for good wear,
- ✓ The 6-cm (2.4-in) AC interlayer providing good bond between the CRC and the lean concrete layer to reduce erosion,
- ✓ The thick granular layer above the subgrade, and
- ✓ The high-strength concrete and its complete resistance to freeze-thaw damage.

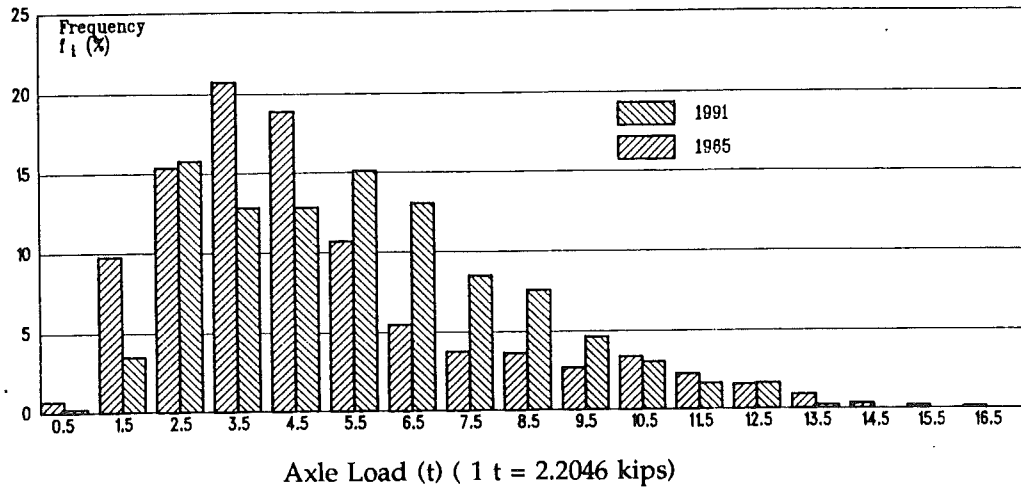

Figure 3.19 Axle-load distribution in Belgium in 1965 and 1991.

A design life of 30 years or more design life with low maintenance is expected due to the tight closely spaced cracks and absence of erosion.

Several recent designs included reduction in steel content to 0.67 percent, placement of the steel 9 cm (3.6 in) deep and elimination of the AC interlayer. This pavement design has not performed as well as the original CRCP design: the cracks are wider and erosion has occurred between the slab and the lean concrete base. It has been reported that the AC layer is now being used again.

CRCP has been built as both new pavement as well as overlays. The CRCP pavement is paved directly over bridge decks. Bridges are designed to carry this increased dead weight.

#### • Belgium References

1. Dechanps, Y., R. De Paepe and P. Dutron, "Belgian Experience With CRCP," Proceedings of the First International Conference on the Design of Concrete Pavements, Purdue University, 1977.
2. Verhoeven, K., "Corrosion in CRCP," Belgian Cement Industry Collective Research Centre, Belgium.

3. Verhoeven, K., "Thin Overlays of Steel Fiber Reinforced Concrete and Continuously Reinforced Concrete - State of the Art in Belgium," Proceedings of the Fourth International Conference on Concrete Pavement Design and Rehabilitation, Purdue University, 1989.
4. "Surface Treatment of Cement Concrete Pavements by the Chemical Removal of Retarded Surface Mortar," ROBUCO Company, Industriepark Gendhof 4, B-9255 Buggenhout, Belgium.

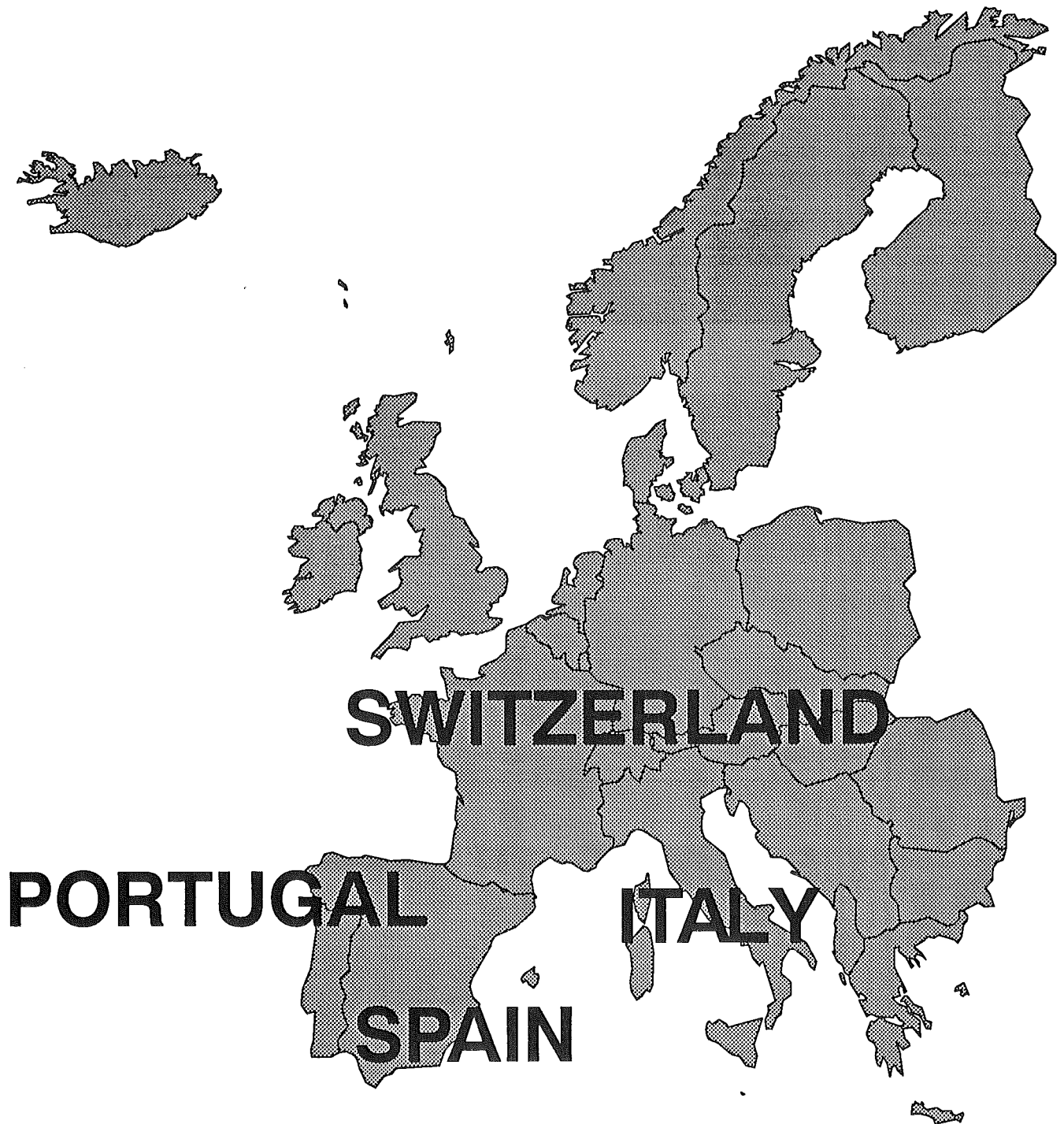

### 3.6 Other Countries (Spain, Portugal, Switzerland, Italy)

Due to travel and time constraints the US TECH Study Tour could not visit all of the countries in Europe that are building concrete pavements. The countries of Spain, Portugal, Switzerland and Italy, among others, have built concrete pavements to varying degrees. A representative from each of these countries graciously agreed to make a presentation to the Study Tour in Dusseldorf, Germany. In addition, a representative of CEMBUREAU, a cement industry association which represents 19 countries, gave a presentation on the use of cement and concrete pavements in Europe. A summary of only the key points of their brief presentations follows.

- Spain

**Early Concrete Pavements.** The first concrete pavement in Spain was built in 1915. A few concrete pavements were built thereafter until the 1960's when a few dowelled JPCP pavements were constructed. The first was a section of dowelled JPCP near Madrid in 1963 having a 25-cm (9.8 in) slab thickness, a sand base and 5 and 6 m (16.4 and 19.7 ft) joint spacing. This pavement gave good performance for many years until it was widened and overlaid in 1981. (1)

In 1968 the first freeway JPCP was constructed near the 1963 project with doweled joints spaced at 6 m (19.7 ft), a 25-cm (9.8 in) slab thickness, a 15-cm (5.9-in) CTB and a 10-cm (3.9-in) sand cement subbase. The shoulders were AC. All joints were sealed with

neoprene compression seals. The traffic level is now about 5000 trucks per day in each direction and the ADT is 80,000. This section is still in good condition, having carried over 30 million trucks in each direction with no significant structural distress.

**California JPCP Design.** In 1971, extensive construction began using slipform pavers and the "California" JPCP undowelled pavement was adopted by the toll roads. Over 700 km (440 miles) of two-lane one-direction freeways of this pavement had been constructed up to 1985, mostly by toll roads. These pavements were generally 25 cm (9.8 in) thick, had skewed joints, and 15 cm (5.9 in) of CTB. A nonplastic granular material was placed under this layer in areas of poor subgrade. No subdrainage pipes were placed. AC shoulders had a granular base. Heavy traffic on these pavements resulted in pumping and faulting, followed by cracking which has caused considerable roughness.

Design modifications made in the late 1970's included thicker slabs, trapezoidal sections (24 to 28 cm (9.4 to 11.0 in)), reduction of joint spacing (3.7-4.6-4.0-4.3 m (12.1-15.1-13.1-14.1 ft)), lean concrete base, cement-stabilized granular base for the AC shoulder, and slotted longitudinal pipe for subdrainage. This pavement design has performed well and faulting is not significant.

**Current Design Catalog.** For heavy truck highways (800 trucks per day in the design lane), due to the availability of automatic dowel inserters, and to provide more reliability against faulting, the conclusion has been



reached that dowels must be used. This is now standard practice in Spain. Contractors are now equipped with automatic dowel insertion equipment. The cross-section is trapezoidal and the thickness depends on the truck traffic and subgrade support. A design catalog is available that specifies the following slab thicknesses:

First Year Trucks per lane per day	Trapezoidal Slab Thickness
> 2,000	26-30 cm (10.2-11.8 in)
< 2,000	23-27 cm (9.1-10.6 in)

A 15-cm (6-in) base, usually lean concrete, is specified for either case. If the subgrade CBR exceeds 20 percent no granular subbase is required. If the subgrade CBR is between 10 and 20 percent, a 20-cm (7.9 in) granular subbase layer is required. If the subgrade CBR is less than 10 percent the soil is unacceptable and must be replaced. (1)

Dowels (2.5-cm (1-in) diameter) in a plastic tube are clustered in each wheel path (18 dowels spaced over two traffic lanes with six dowels in the outer wheel path spaced every 30 cm (11.8 in)). Transverse joint spacing is 5 m (16.4 ft), perpendicular to the centerline, and sealed in wet areas but not sealed in dry areas. Longitudinal joints are sealed in all pavements and include tie bars. (1)

**Concrete for Slab and Base.** Concrete containing crushed limestone as the coarse aggregate has proven to yield low shrinkage and good flexural strength, and facilitates joint sawing. The requirement that at least 30 percent of the fine aggregate be composed of siliceous particles has resulted in pavements without friction problems associated with texture wear. Concrete must attain a flexural strength at 28 days of 4.5 MPa (640 psi) in third-point loading. Lower-strength concrete can be used but the slab thickness must be increased. Blended cements containing flyash are used in the concrete (38 percent) and lean concrete base (50 percent). A large cost reduction was obtained by the government for these blended cements. The water/cement ratio is between 0.44 and 0.50, slump is between 2 and 4 cm (0.8 and 1.6 in), and plasticizers are used in drier mixes.

The lean concrete or cement-treated bases must have a minimum compressive strength of 8 MPa (1143 psi) at seven days; or alternatively not less than 12 MPa (1714 psi) at 90 days for slower-strength-gaining mixtures. To prevent reflection cracks from the base to the slab, a plastic sheet is laid on top of the base.

**Curing Compounds.** The high temperatures and low relative humidity in Spain have made it necessary to use high-quality curing compounds based on organic resin solutions.

**Joint Sawing.** The extreme temperature gradients prevalent during construction produce high curling stresses. It is necessary to saw the

longitudinal joint at the same time as the transverse ones instead of delaying its cutting which is the usual practice. All of the joints need to be cut the same day the concrete is placed.

More than 800 km (500 miles) of two-lane, on-direction freeways have been constructed with this general design. These pavements are performing very well in Spain.

**CRCP Design.** CRCP was constructed on one long section in northern Spain in 1975. This section has carried very heavy traffic (ADTT exceeding 5,000). Two traffic lanes are 7.5 m (24.6 ft) wide, 22 cm (8.7 in) thick, with a 16-cm (6.3-in) CTB, and a 22-cm (8.7-in) granular subbase. The amount of reinforcement was 0.85 percent. One test section had 0.73 percent with no change in the pattern of cracking. The steel was placed on chairs. The performance of the CRCP has been excellent and has required very little maintenance work. Recently, other CRC pavements have been constructed. The design catalog allows a thickness reduction of 4 cm (1.6 in) from JPCP. (1)

**Surface Texture.** Many surface texturing techniques have been used in Spain, ranging from burlap to tining. Longitudinal texturing produced by a combination of brush and comb achieves both a microtexture (with the brush) and a macrotexture (with the comb), whose initial grooves are about 1.5 mm (0.06 in) deep. However, in the latest construction project a less rough texture is sought: 0.7 to 1 mm (0.03 to 0.04 in). Measurements of friction and rolling noise taken after

several years of operation demonstrated that these procedures have given excellent results. (1)

**Roller-Compacted Concrete.** This material is defined as a homogenous mixture of aggregate, water and cement which is laid in similar fashion to CTB, although its cement content is similar to that of regular concrete pavements. Over 4 million square meters (4.78 million square yards) of roller-compacted concrete pavement have been constructed in Spain since 1970 on low- and high-volume roads, widening, and overlays.

Roller-compacted concrete requires no specialized equipment and enables the road to be immediately opened to traffic after compaction. This is particularly beneficial for overlays. Surface unevenness problems require an 8- to 10-cm (3.1- to 3.9-in) AC overlay for higher-speed pavements. The RCC ranges from 22 to 25 cm (8.7 to 9.8 in) and the soil cement base is 20 cm (7.9 in) thick. Lighter roads require thinner layers.

Joints are now provided at 7- to 10-m (23- to 33-ft) intervals to try to reduce reflection cracking through the AC layer. One section recently constructed near Madrid had a joint spacing of 2.5 to 3.5 m (8.2 to 11.5 ft). After two years and over 1 million trucks, only 0.5 percent of the cracks have reflected through. (1)

**Traffic.** Truck traffic in Spain on freeways ranges from 1000 to over 5000 ADTT in one direction. The legal axle load limit in Spain is among the highest in the world: 13 t (28,600 pounds) for a single axle and 21 t

(46,300 pounds) for a tandem axle. The most recent weigh-in-motion data have shown 4 percent of axles above the legal limit, with some loadings of 20 t (44,000 pounds) on a single axle and 30 t (66,000 pounds) on tandem axles.

### Spain Reference

1. Jofre, C., "Spanish Practice and Experience With Concrete Pavements," paper presented to the US TECH Study Tour in June, 1992.

- Portugal

Concrete pavements were constructed in Portugal during three time periods:

- ✓ 1935-1945, when 70 km (43 miles) of heavily trafficked routes were constructed with concrete. These are all still in service.
- ✓ 1945-1965, when some concrete pavements were constructed on military bases. In 1965 the first prestressed pavement in the world was constructed at Beja NATO airfield.
- ✓ 1965 on, when construction of the national network of highways began. Because of increased axle loads and increased traffic, concrete pavements are very competitive with asphalt pavements. The design life used in Portugal is 30 to 40 years. From 1986 to 1992 about 130 km (80 miles) of concrete pavements (mostly JPCP) were constructed. This was 10 percent of the total highway mileage constructed, and included the first JRCP and CRCP. Concrete paving blocks are also used in Portugal.

It is expected that about 20 percent of the major highways will be constructed of concrete.

The current JPCP design used in Portugal is a 23-cm (9.1 in) slab with 15 cm (5.9 in) of CTB. The current JRCP design is a 20-cm (7.9 in) slab and a 15-cm (5.9-in) CTB. The longitudinal reinforcement is 0.06 percent area.

- Italy

The past (that brought about the present): Ancient Rome was the center of an extensive 80,000 km (50,000 mi) network of roads that crossed many countries. The first link to the south was the ancient Via Appia (or Appian Way) that radiates out from the center of Rome. Construction of the Via Appia began in 312 B.C., and it is still being used today after 2,000 years, as shown in Figure 3.20. The Via Appia has been called the "most famous road ever built in any age or any clime."(3)

"The prestige of the Via Appia has continued to grow with each succeeding century because of the excellence and durability of its construction." (3)

Grooves from ancient wheels were observed on some of the stones. The original surfacing layers are gone, and the existing surfacing consists of fairly large stones imbedded in the foundation. This pavement is up to 10.7 m (35 ft) wide with curbs on both sides.



Figure 3.20 Via Appia Roman road, built 312 B.C., south of Rome (note that the truck is parked off the main road).

"In the most advanced stage of its improvement, Via Appia was built by first excavating a trench in the natural soil down to a solid foundation. The earth was tamped with beetles and covered with a light bedding of sand or mortar upon which were laid four main courses:

- (1) The 'statumen' layer of large, flat stones 25 to 60 cm (10 to 24 in) in thickness;
- (2) Next the 'rudus' course of smaller stones mixed with lime, some 23 cm (9 in) thick;
- (3) The 'nucleus' layer, about 30 cm (12 in) thick, consisting of small gravel and coarse sand mixed with hot lime; and

(4) On this fresh mortar was placed the 'summa crusta,' or wearing surface, of flint-like lava, about 15 cm (6 in) deep.

The total thickness of the four courses described above varied from 0.9 to 1.5 m (3 to 5 ft). The massive solidity of this thick roman cross-section was standard practice for more than 2,000 years until superseded by Macadam's light wearing surface in the nineteenth century." (3)

Although these roads were built primarily for military purposes, it is hard to imagine the long-term thinking that went into building such incredibly thick and durable pavements to carry the traffic that existed at the time.

Some interesting axle weights:

✓ Maximum Roman axle load for slow freight wagons: 0.7 t (1,436 pounds) (3)

✓ Recommended wagon axle load by Telford in 1819 (England): 1.8 t (4,000 pounds) (3)

✓ Current legal axle load in USA 9.1 t (20,000 pounds)

✓ Current legal axle load in some European countries: 13 t (28,652 pounds)

One historian stated that "As early as the eulogy of Appius Claudius the building of the Via Appia was put on the same plane as military victories or political deeds." Another historian stated, "The Roman engineers had a clear idea of the true value of the road and of false economy in materials and labor, and their technique has not been excelled until quite recent years."

These ancient Roman roads that were built over many parts of Europe must have had an influence on modern day Europeans as to the value of making a substantial investment in a quality highway infrastructure that will provide service for long time periods without disruption.

The present: JPCP without dowels and JRCP were built in Italy from 1950 to 1975. One heavily trafficked JRCP was observed in Rome by a Study Tour member, a four-lane highway (the modern Via Appia) constructed in 1950 (42 years old). The pavement has a 20-cm (7.9-in) thick slab, 12 m (39 ft) joint spacing, and was observed to be in fair condition with joint spalling and some

deteriorated transverse cracks. Some joints had been repaired with concrete. The concrete is very dark because it contains a dark igneous rock. Expansion joints had been cut in the pavement which allowed nearby cracks and joints to open up and deteriorate.

**Traffic.** On Italian highways, trucks are typically 25 to 30 percent of ADT. Axle load distributions from the weigh-in-motion scale on the A1 freeway near Rome for singles and tandems are given in Figure 3.21. The measured maximum single axle load is 14 t (30,900 pounds), the tandem axle limit is 29 t (63,900 pounds), and the triple axle limit is 39 t (86,000 pounds).

The Autostrade toll road company has recently developed a design called Polyfunctional Composite Pavements (PCP). (1) This design consists of the following:

- ✓ 4 cm (1.6 in) porous asphalt surface
- ✓ 22 cm (8.7 in) CRCP (12.8 m (39 ft) wide with two longitudinal joints)
- ✓ 20 cm (7.9 in) CTB
- ✓ 20 cm (7.9 in) granular layer

**PCP A1 Project.** Two major PCP projects were constructed in 1988 on the A1 and the A12 near Rome, both of which have very heavy truck traffic (approximately 5,000 trucks in one direction). The crack spacing in the CRCP was reported to be 1.2 to 2.5 m (3.9 to 8.2 ft). This section has three lanes in one direction and the CRCP slab is 12.8 m (42 ft) wide with two longitudinal joints. One key aspect is that the two longitudinal joints are spaced so as not to be in the wheel paths of trucks, so that truck wheels usually produce interior loads.

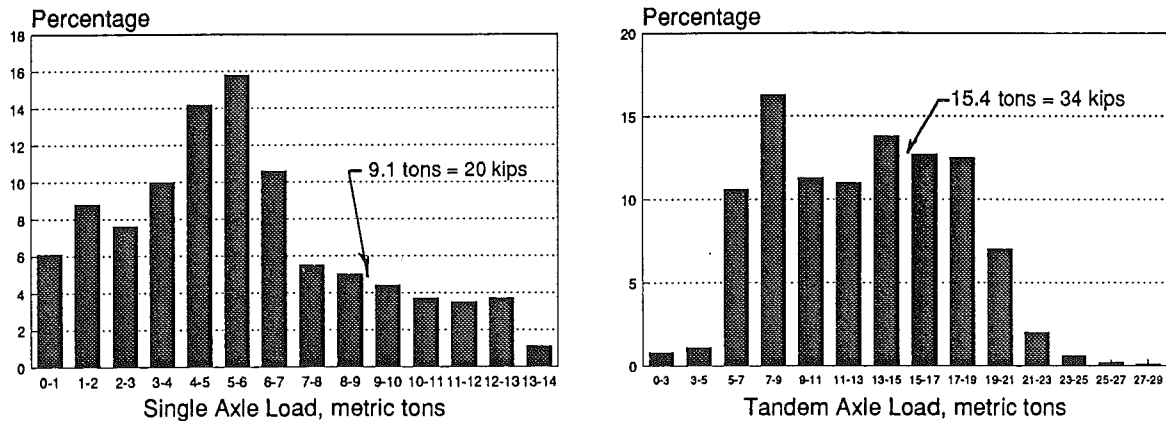

Figure 3.21 Italian axle load distributions measured near Rome on freeway system.

Also, the CRCP continues on 1.8 m (5.9 ft) beyond the painted edge stripe to eliminate any edge loading. At this point, a porous concrete base begins to provide for drainage. This pavement has a 2.5 percent cross-slope. No cracks or any other distress were observed after four years of service. The porous asphalt surfacing provides a very quiet ride. There is a noticeable difference (about 3-4 dB) between this surface and a conventional AC surface that exists on the next section of the A1.

Concrete properties measured on the A1 CRCP project are as follows: (2)

- ✓ Mean flexural strength at 28 days: 8.3 MPa (1186 psi)

- ✓ Mean compressive strength at 28 days: 56.5 MPa (8072 psi)

- ✓ Water/cement ratio: 0.42

This design has the following advantages: (1)

- ✓ Eliminates hydroplaning,
- ✓ Eliminates tire spray,
- ✓ Good friction resistance,
- ✓ Low emission of tire/pavement noise,
- ✓ Smooth ride,
- ✓ Waterproofing of cracks in CRCP,
- ✓ Resistance to fatigue due to interior loadings, and
- ✓ Easier maintenance (surface replaced at seven years)

It is expected that about every seven years the porous AC will need to be milled off and replaced due to clogging from fines or other problems. The total structural design life is 40 years.

**Cost Comparison.** A cost comparison of the PCP versus the conventional semi-rigid pavement that has an AC surface over lean concrete or CTB was given as follows, where R equals the ratio of the cost of the PCP divided by the cost of the semi-rigid pavement:

Item	R
Construction	1.30
Maintenance	0.30
User costs	0.55
Total life-cycle costs	0.87

**Italy References**

1. Camomilla, G. and A. Marchionna, "P.C.P. Polyfunctional Composite Pavements," Technical Report, Autostrade Central Maintenance and Research Division, Rome, Italy, 1991.
2. Marchionna, A., et al., "Cement Concrete Characteristics for Road Pavements, Practical Experience with the Polyfunctional Composite Pavement," Proceedings: 6th International Symposium on Concrete Roads, Madrid, Spain, 1990.

3. Rose, A. C., "Public Roads of the Past - 3500 B.C. to 1800 A.D.," AASHTO, Washington, D.C., USA, 1952.

• **Switzerland**

Switzerland has a 70-year tradition in building concrete pavements. Several existing concrete pavements were shown to the Study Tour. A design catalog is available that was developed using the AASHTO design procedure and varying the subgrade and traffic level. A manual for concrete pavement design and construction practices dated 1992 will soon be available. It was reported that concrete pavements require about 20 percent less electrical energy for lighting than AC pavements due to the lighter surface. JPCP, CRCP and prestressed pavements have been constructed in Switzerland.

**Example Project.** The main runway at Basal airport was built in 1956 and was rehabilitated in 1986. Slabs were replaced during the night and opened to traffic at 5 A.M. with about 4.5 hours of curing time. The central keel section (24 m ((79 ft) wide by 2600 m (8530 ft) long) was completely replaced over a three-week period. This required only one week of complete closure for all traffic and then night work for two weeks where some heavier aircraft were restricted from using the runway during the day.

**Concrete Durability.** The key aspect of the Switzerland presentation was their quality control program to achieve high durability. Since 1965, highways in Switzerland have been deiced using large amounts of chemical deicing salts. This has increased the

durability requirements for concrete pavement. Existing pavements at that time suddenly developed damage from scaling as well as concentrated disintegration of the concrete paste structure.

The durability of the concrete was improved by increasing the quantity of air voids, graded according to size and uniform distribution in the cement paste. The measurement of the total content of air voids of the fresh concrete was not sufficient for the evaluation of frost and salt durability. They believe that only an appropriate testing method applied to the hardened concrete can give valid information. (1)

The total air content should never be less than 4.5 percent of total mix volume. However, during placing, consolidating and finishing of concrete the total pore fraction, pore distribution, and pore size in the hardened concrete may be affected. Therefore, rapid and practical procedures were developed to examine these in the hardened concrete for construction projects. The microscopic control of concrete is carried out on thin sections made from a concrete core specimen impregnated with a special fluorescent dye and examined under the microscope in transmitted ultraviolet light. The complete quality control process is as follows:

✓ Laboratory tests are conducted a few months before the project begins. Several concrete mixes are prepared to develop a mix design of high durability. The aggregates are submitted to quality control: grain shape, repartition, porosity, cracks, content of mica and impurities are

checked. Attention is paid to the bond quality between aggregates and cement paste. The suitability of the selected air-entrainment agent is checked and the proper dosage determined. The air void system, size, quantity and distribution in the cement paste are measured. (1)

✓ Trial run tests take place two or three weeks before construction to evaluate the batching, mixing plant and placement equipment to test the suitability of the mix design from the laboratory under in situ working conditions. The concrete is mixed, hauled and placed in two or three trial slabs that are constructed on site. Several test cores are obtained as soon as possible and tested in the laboratory. These results are compared to those obtained from the previous laboratory results and any adjustments needed are made to the mix or construction process. (1)

✓ During the first few days of construction, cores are taken from the pavement and tested in the laboratory. A microscopic analysis is again conducted to ensure the hardened concrete maintains the proper air void system. These results are available within 36 hours after the concrete is placed. If the air void system is inadequate, a rapid-cycle freeze-thaw test is conducted on one of the cores (Dobrolubov-Romer method). (2)

If the air void system is inadequate, the surface of the concrete is impregnated with an agent (3). These quality control procedures have led to the elimination of frost-salt durability problems in concrete pavements in Switzerland.



**Switzerland References**

1. Wilk, W. and G. Dobrolubov, "Microscopic Quality Control of Concrete during Construction," Bulletin of Betonstrassen AG, Concrete Roads Ltd., Wildegg, Switzerland, July/September 1981.
2. Dobrolubov, G. and B. Romer, "Guidelines for determining and testing the frost as well as frost-salt resistance of cement-concrete," Bulletin of Betonstrassen AG, Concrete Roads Ltd., Wildegg, Switzerland, June 1985.
3. Wilk, W., "The development of quantitative and qualitative microscopic control of concrete quality and durability," paper presented at the 6th International Conference on Cement Microscopy, March 26-29, 1984, Albuquerque, New Mexico, USA.

## 4 ACRONYMS, DEFINITIONS, AND TECHNICAL TERMS

### AASHTO

American Association of State  
Transportation Officials  
444 North Capitol Street, N.W.  
Suite 225  
Washington, D.C. 20001  
Phone (202) 624-5800

### ACPA

American Concrete Pavement  
Association  
3800 North Wilke Road, Suite 490  
Arlington Heights, Illinois 60004  
Phone (708) 394-5577

### FHWA

Federal Highway Administration  
400 Seventh Street, S.W.  
Washington, D.C. 20590  
Phone (202) 366-0660

### PCA

Portland Cement Association  
5420 Old Orchard Road  
Skokie, Illinois 6007-1083  
Phone (708)966-6200

### SHRP

Strategic Highway Research Program  
818 Connecticut Avenue, N.W.  
Suite 400  
Washington, D.C. 20006  
Phone (202) 334-3774

### TRB

Transportation Research Board  
2101 Constitution Avenue, N.W.  
Washington, D.C. 20418  
Phone (202) 334-2989

### Definitions/Technical Terms

PCC - Portland cement concrete  
AC - Hot-mixed asphalt concrete  
RAP - recycled asphalt concrete (used  
in recycled concrete)  
LCB - lean concrete base  
CTB - cement-treated base  
JPCP - jointed plain concrete  
pavements (with or without dowels)  
JRCP - jointed reinforced concrete  
pavements  
CRCP - continuously reinforced  
concrete pavements  
dB(A) - noise emission level in decibels  
US TECH - U.S. Tour of European  
Concrete Highways  
NCHRP - National Cooperative  
Highway Research Program (USA)  
LCPC - Laboratoire Central des Ponts  
et Chaussees - Central Laboratory of  
Bridges and Roads in France  
CEMBUREAU - European cement  
association  
BAST - Bundesanstalt fur  
Strassenwesen (Federal Highway  
Research Center in Germany)  
ISTEA - Intermodal Surface  
Transportation and Efficiency Act of  
1991 (USA highway legislation)  
R & D - research and development

### Common SI (modern metric) conversion units used in this report:

t - metric ton (1 t = 2204.62 pounds)  
MPa - megaPascal (1 MPa = 145 psi)

**5 Appendix**

**Petrographic Report**

**on German Autobahn Concrete Pavement**

**and**

**Synoptic Table on Standards and Practices**

**for Concrete Roads in Europe**



5420 Old Orchard Road, Skokie, Illinois 60077-1030  
Phone: 708/965-7500 Fax: 708/965-6541

## PETROGRAPHIC SERVICES REPORT

*CTL Project No.:* 154115

*Date:* July 30, 1992

*Re:* Microscopical Examination of a Concrete Fragment from the Autobahn near Berlin, Germany

One concrete fragment (Fig. 1) was received on July 13, 1992 from Mr. Lawrence Cole, Portland Cement Association. The fragment was reportedly taken from a section of the Autobahn concrete pavement near Berlin, Germany. The concrete is believed to have been placed in 1938. Petrographic examination of the sample was requested by Mr. Cole to determine the quality of the concrete.

### FINDINGS AND CONCLUSIONS

Based on the results of the tests performed, the following findings and conclusions are presented:

1. The sample is a hard, dense, good quality concrete consisting of siliceous and calcareous aggregates in a portland cement paste. The paste-aggregate bond is tight and the concrete fractures through coarse and fine aggregate particles.
2. Estimated water-cement ratio, based on paste properties, is less than 0.35. Large residual cement particles (unhydrated portland cement clinker, UPC's) are abundant.
3. The concrete is not air entrained. Estimated air content is 1 to 2%. Most air voids are small and lined or filled with secondary deposits, mostly ettringite.
4. One major crack, parallel to a fractured surface, is present. This crack may have been produced during sampling. Microcracks are not observed.

Additional data from the petrographic examination are contained in the attached form.

### METHODS OF TEST

Petrographic examination of the concrete fragment was performed in accordance with ASTM C 856-83, "Standard Practice for Petrographic Examination of Hardened Concrete."



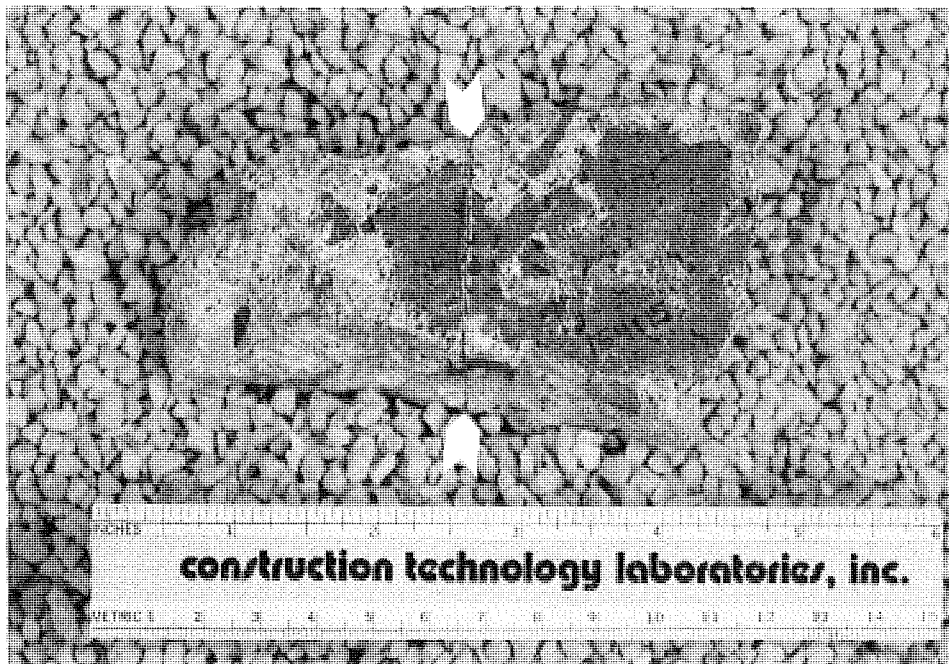
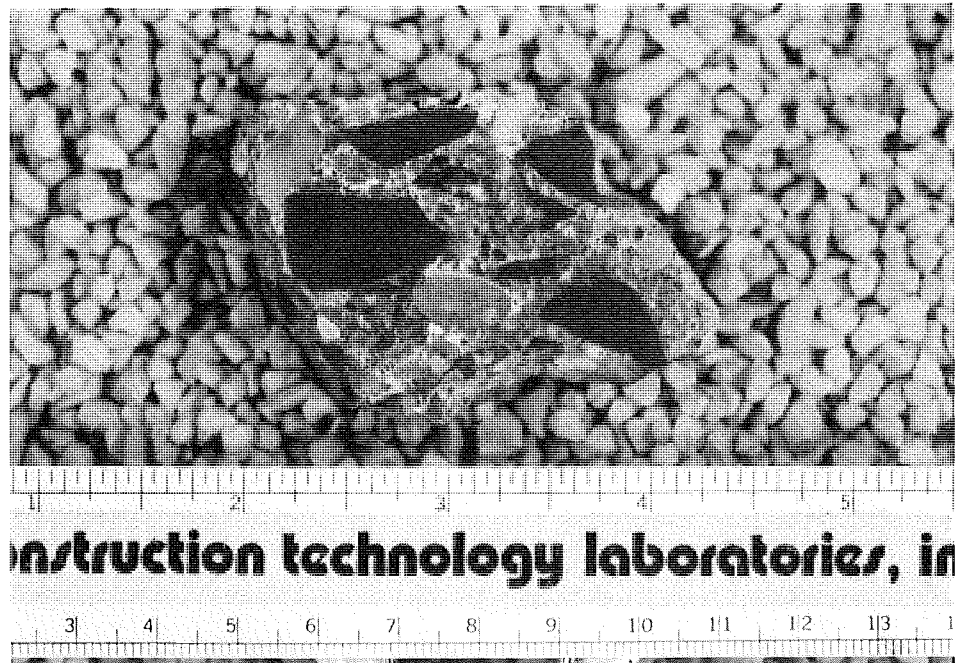

FIG. 1 CONCRETE FRAGMENT FROM AUTOBAHN NEAR BERLIN, GERMANY. BROWN SURFACE IS PROBABLY A MOISTURE BARRIER IMPRESSION. ARROWS SHOW LOCATION OF SAWCUT. PORTION OF SAMPLE ON LEFT IS SHOWN IN FIG. 2.



**FIG. 2 LAPPED SURFACE OF AUTOBAHN CONCRETE FRAGMENT ORIENTED WITH BARRIER IMPRESSION AT TOP OF PHOTOGRAPH.**

**CTL**

The fragment was cut perpendicular to the formed surface and one portion was lapped. Lapped and freshly broken surfaces were studied using a stereomicroscope at magnifications up to 45X. A rectangular block, approximately 1-in. wide and 2-in. long, was cut from the sample, placed on a glass microscope slide with epoxy resin, and reduced to a thickness of approximately 20 micrometers (0.0008 in.). The thin section was examined using a polarized-light microscope at magnifications up to 400X to determine aggregate and paste mineralogy and microstructure.



L. J. Powers-Couche  
Associate Petrographer  
Petrographic Services

LJP/djp



## PETROGRAPHIC EXAMINATION OF HARDENED CONCRETE, ASTM C 856

CTL PROJECT NO.: 154115

DATE: JULY 30, 1992

CLIENT: PCA Public Works Dept. #322

PROBLEM: Quality Evaluation

STRUCTURE: Concrete Pavement

EXAMINED BY: L. Powers-Couche

LOCATION: Autobahn near Berlin, Germany

Page 1 of 2

### SAMPLE:

**Identification:** None stated.

**Dimensions:** The sample is a broken fragment approximately 2.5-in. wide, 3.5-in. long, and 1.7-in. thick. All surfaces but one are broken surfaces passing through coarse aggregates. One surface appears to be a formed surface, perhaps formed against a flexible barrier. The surface is smooth, undulating, dark brown, with abundant, irregularly-shaped, entrapped air voids up to 0.3-in. diameter.

**Cracks, Joints, Large Voids:** One crack, 0.6-in. long, is parallel to a fractured surface.

**Reinforcement:** None present.

### AGGREGATES (A)

**Coarse (C):** Siliceous and calcareous gravel mainly consisting of basalt, fossiliferous limestone, granite, schist, and graywacke.

**Fine (F):** Siliceous and calcareous sand consisting of quartz, quartzite, limestone, feldspar, and a small amount of mica, iron oxides, and hornblende.

**Gradation & Top Size:** The aggregate appears to be evenly graded to a top size of 0.6 in.

**Shape & Distribution:** Both CA and FA are rounded to angular, and appear to be uniformly distributed. FA particles are equant to oblong. CA are oblong to elongated.

### PASTE

**Color:** Medium to dark gray.

**Hardness:** Hard.

**Luster:** Subvitreous.

**Calcium Hydroxide\*:** 5 to 7% uniformly distributed, small crystals, patches, and partial coatings on aggregates.

**Unhydrated Portland Cement Clinker Particles (UPC's)\*:** 15 to 18% uniformly distributed large UPCs. Few relicts observed.

**Depth of Carbonation:** 0.03 in. carbonation measured from the smooth, formed surface.

**Air Content:** The concrete is not air entrained. 1 to 2% oval air voids up to 0.06-in. diameter are nonuniformly distributed in the paste. Most voids occur adjacent to aggregate particles.

**Fly Ash\*:** None present.

**Paste-Aggregate Bond:** Tight. The concrete fractures through coarse and fine aggregate.

**Secondary Deposits:** Voids are lined and/or filled with calcium hydroxide and ettringite. Ettringite occurs in clusters or clumps of long needles.

**Microcracking:** No significant microcracks observed.

**ESTIMATED WATER-CEMENT RATIO:** Less than 0.35.

**MISCELLANEOUS:** The portland cement was coarsely ground. One large clinker particle is 400 micrometers-long and 150 micrometers-wide.

\*percent by volume of paste



# **6th INTERNATIONAL SYMPOSIUM ON CONCRETE ROADS**

Madrid, 8-10 October 1990  
PIARC/Cembureau/Oficemen

## **SYNOPTIC TABLE**

**on standards and practices for concrete roads in Europe**

by

Carlos Jofré  
Instituto Español del Cemento  
y sus Aplicaciones, Madrid

Carlos Kraemer  
Universidad Politécnica de Madrid

with kind assistance from members and experts of the  
PIARC Technical Committee on Concrete Roads

Grateful acknowledgement is given to the following members and experts from the PIARC Technical Committee on Concrete Roads for furnishing the authors with the information about their respective countries:

H. Sommer (Austria)  
P. Sion (Belgium)  
E. Slachta (Czechoslovakia)  
P. Nepper-Christensen (Denmark)  
K. Lundström (Finland)  
J. L. Nissoux (France)  
K. Rossberg (German Democratic Republic)  
A. Vollpracht (Federal Republic of Germany)  
G. D. S. Northcott (Great Britain)  
L. Domenichini (Italy)  
M. Leewis (The Netherlands)  
H. Magerøy (Norway)  
A. Pinelo (Portugal)  
O. Petersson (Sweden)  
G. Tsohos (Switzerland)

**Glossary of symbols used****Symbol/Interpretation**

R	Definitely required by specifications or regulations
P	Permitted by specifications under certain conditions or requirements
X	Specifically prohibited
OC	Optional with contractor
N	Not included in specifications
A	As shown on plans
E	Where directed or authorised by engineer
M	Motorways
MR	Main roads
SR	Secondary roads

**Signification des symboles****Symbole/Interprétation**

R	Formellement exigé par les prescriptions ou par la réglementation
P	Permis para les prescriptions dans certaines conditions ou pour faire face à certaines exigences
X	Formellement interdit
OC	A la discrétion de l'entrepreneur
N	Non inclus dans les prescriptions communes ou spéciales
A	Conformément aux plans
E	Conformément aux instructions ou avec l'autorisation de l'ingénieur
M	Autoroutes
MR	Routes principales
SR	Routes secondaires

**Zeichnerklärung****Zeichen/Bedeutung**

R	Definitiv in Vorschriften oder Bestimmungen gefordert
P	Gestattet nach Vorschrift unter bestimmten Bedingungen oder zusätzlichen Forderungen
X	Definitiv verboten
OC	Dem Unternehmer freigestellt
N	Nicht in Bestimmungen enthalten
A	Nach Zeichnung
E	Wenn von der Bauleitung angeordnet oder zugelassen
M	Autobahnen
MR	Hauptstrassen
SR	Nebenstrassen

**Significado de los símbolos****Símbolo/Significado**

R	Exigido por las prescripciones técnicas
P	Permitido por las prescripciones bajo ciertas condiciones
X	Prohibido por las prescripciones
OC	A elección del contratista
N	No incluido en las prescripciones
A	Según lo indicado en los planos
E	De acuerdo con las instrucciones del Director de obra o con su autorización
M	Autopistas
MR	Carreteras principales
SR	Carreteras secundarias

## COUNTRY AND NUMBER CODE

1. Austria
2. Belgium
3. Czechoslovakia
4. Denmark
5. Finland
6. France
7. Germany (Democratic Republic)
8. Germany (Federal Republic)
9. Great Britain
10. Italy
11. Netherlands
12. Norway
13. Portugal
14. Spain
15. Sweden
16. Switzerland

BASIC DESIGN REQUIREMENTS / PRESCRIPTIONS POUR LE PROJET / ALLGEMEINE BAURICHTLINIEN / PARAMETROS BASICOS DE PROYECTO

Maximum axle or wheel load permitted Charge maximale permise par essieu ou par roue Höchstzulässige Achsoder Radlast Carga máxima por eje o por rueda autorizada	Design traffic (commercial vehicles per day) Trafic de projet (nombre de camions par jour) Verkehrsbelastung (LKW/Tag) Tráfico de proyecto (vehículos pesados por día)	Slab thickness Epaisseur de la dalle Plattendicke Espesor del pavimento mm	Width of carriageway elements / Largeur des voies / Streifenbreiten / Ancho de los elementos de la calzada			
			Motorways / Autoroutes / Autobahnen / Autopistas			
			Traffic lanes Voies pour le trafic Fahstreifen Carriles para circulación m	Marginal strips Surlargeurs Randstreifen Sobrecanchos m	Hard shoulders Bandes d'arrêt d'urgence Standstreifen Arcenes m	Lane for slow traffic Voie supplémentaire en rampe Kriechstreifen Cerril para vehículos lentos m
1	2	3	4	5	6	7
1 10 t single axle	Equivalent number of 10 t single axles for 30 years	Depending on design traffic (150-250)	3,75	1,00 inside 0,50 outside	2,50	3,75
2 13 t	4.500	CRC 20 cm Plain concrete 23 cm	3,75	1,00	3,00	3,75
3 M 10 t single axle		M 240	3,75	0,50	2,50	3,50
4 10 t single axle From 1992: 11,5 t on driving axle Special rules for low loaders, often leading to axle loads of 12 t		M: 200-300 MR: 180-300	3,50-3,75	0,50	A	A
5 Single axle load 10 t	Not specified	Not specified (Min. 200 when provision for grinding is included)	3,75	0,50	2,25	3,50
6 Single axle 13 t	On design lane: T0 750-2000 T1 300-750 T2 150-300 T3 50-150	Related to design traffic and subgrade URC 280-220 URC, dowelled joints 230-180 CRC 220-170 Thick slab (not for T0) 370-300	3,50	Outside = 0,75-0,25 according to traffic inside = 0,25	2,50-3,00	3,50
7 R Max. axle load 11 t	Traffic classification depending on number of equivalent 10 t axle passages	140-260 depending on - axle passages - strength of concrete - dowelled or undowelled joints	R 3,75	R 1,50 P 1,00	R 2,50	R 3,50
8 R Single axle 11 t (from 1992 11,5 t) Tandem axle 18,0 t (from 1992 19,0 t)	R M: >3200 MR: 1800-3200 300-1800 SR: 60-300 < 60	R M: 280 MR: 240-220 SR: 200-180-160 depending on the (sub-) base	R 3,75 (preferred) 3,50	R Outside 0,50 Inside 0,50 or 1,00	R 2,50 2,00	R 3,75
9 Single axle 10 t	URC 200 to 10 000 JRC 300 to 10 000 CRC 1600 to 10 000 CRCR 900 to 10 000	A Related to traffic URC 150 to 340 JRC 150 to 320 CRC 200 to 280 CRCR 150 to 250 (plus 100 mm bituminous surfacing)	A 3,65	A 0,70	A 3,30	A 3,65
10 R Single axle: 12 t Tandem axle: 19 t	N	N 220-240 depending on type of pavement (CRC-JPC)	R 3,75	R 0,12-0,20 White painted mark	R 3,00	R 3,00
11 M MR SR Single axle 11,5 t	Number of single axles (tandem=2 singles tridem=3 singles)	N 180-250	R 3,50 (rural and urban)	R 0,60	R 3,00	N
12 R Single axle 10 t	Number of equivalent standard 10 t axles along design period	R ADT < 6.000 130 8.000 140 16.000 180 50.000 200 (4 lanes) Normally 200-220	R 3,50	R 1,00	R 1,50 or 3,00 (depending on motorway class)	R 3,50
13 R Single axle 12 t Tandem axle 20 t Tridem axle 24 t	A Number of standard axles 13 t	A 200-600	R 3,75	R 0,20	R 3,00	R 3,00-3,50
14 R Single axle 13 t Tandem axle 21 t	R Design based on number of commercial vehicles on the design lane in the year of opening to traffic	R 280-200 For one-way carriageways linear variation of thickness is specified. Thickness also depending on concrete strength				
15 Single axle 10 t (11,5 t: + 15 mm) (13,0 t: + 25 mm)	2000-4000	Depending on concrete strength 4,8 6 7 N/mm <sup>2</sup> 220 200 190 mm	4,50	0,50		
16 R Single axle 8,2 t	R T1 10- 30 T2 31- 100 T3 101- 300 T4 301- 1000 T5 1000- 3000	R 150-230 Depending on the base or sub-base bearing capacity	R 4,00		R 2,50	R 4,00

Width of carriageway elements / Largeur des voles / Streifenbreiten / Ancho de los elementos de la calzada

Main roads / Routes principales / Hauptstraßen / Carreteras principales				Secondary roads / Routes secondaires / Nebenstraßen / Carreteras secundarias		
Traffic lanes Voies pour le traffic Fahrstreifen Carriles para circulación	Marginal strips Surlargeurs Randstreifen Sobrecanchos	Hard shoulders Bandes d'arrêt d'urgence Standstreifen Arcenes	Lane for slow traffic Vole supplémentaire en rempe Kriechstreifen Carril para vehiculos lentos	Traffic lanes Voies pour le trafic Fahrstreifen Carriles para circulación	Marginal strips Bandes de guidage Randstreifen Sobrecanchos	Hard shoulders Bandes d'arrêt d'urgence Standstreifen Arcenes
m	m	m	m	m	m	m
8	9	10	11	12	13	14
1 3,50	0,50	N	3,50	A	A	A
2 3,50	None	None	3,50	3,00 to 3,50	None	None
3						
4 3,50	0,50	A	A	A	A	A
5 3,50	0,25	1,00	3,50	3,00-3,50	0,25	0,25-0,50
6 3,00-3,50	Outside = 0,75-0,25 according to traffic Inside = 0,25	When used, 2,50-3,00	When used, 3,50	2,50-3,50	0,25	Seldom used
7 3,00-3,75 depending on traffic	R 1,50 P 1,00	N	3,00-3,50	2,50-3,25	R 1,00	N
8 R 3,75 3,50 3,25 3,00	R 0,50 0,25	R 2,50 2,00 1,50	R 3,75 3,00	R 3,75 3,50 3,25 3,00	0,50 0,25 0,00	R 1,50 or no hard shoulder
9 A 3,65	A 1,00	N	A 3,65	A 3,65 or 5,00	A 1,00	N
10 R 3,50-3,75	R 0,12-0,20 White painted mark	R 1,50-1,75	N	R 3,00-3,50	R 0,10-0,15 White painted mark	R 1,00-1,25
11 R 3,25 (rural) 3,10 (urban)	R 0,45	N	N	N 3,10 or 2,75	N 0,45 (if lane width = 3,10 m) 0,20 (if lane width = 2,75 m)	N
12 R 3,25-3,75	R 0,50 or 1,00	R 2,50 2,00 1,50	R 3,75 3,00	R 3,75 3,50 3,25 3,00	0,50 0,25 0,00	R 1,50 or no hard shoulder
13 R 3,50	R 0,15-0,20	N	A 3,65	A 3,65 or 5,00	A 1,00	N
14		R 1,50-1,75	N	R 3,00-3,50	R 0,10-0,15 White painted mark	R 1,00-1,25
15 N	N	N	N	N	N	N
16 R 3,50	R 0,50-1,00	Normally not used	R 3,00		R 0,50	

SUB-BASE MATERIALS/COUCHES DE FONDATION/TRAGSCHICHT/MATERIALES PARA CAPAS DE BASE

Cement treated / Traitées au ciment / mit hydraulischen Bindemitteln / Tratados con cemento					Requirements for other materials Exigences pour autres matériaux	Surface regularity Uni Oberflächenebenheit Regularidad superficial
Materials used and thickness / Nature des matériaux et épaisseur Benutzte Baustoffe und Schichtdicke / Materiales utilizados y espesor mm		Requirements / Exigences / Anforderungen / Prescripciones				
Motorways and main roads Autoroutes et routes principales Autobahnen und Hauptstraßen Autopistas y carreteras principales	Secondary roads Routes secondaires Nebenstraßen Carreteras secundarias	Cement content Teneur en ciment Bindemittelgehalt Contenido de cemento	Compressive strength or other Résistance à la compression ou autres Druckfestigkeit oder andere Resistencia a compresión o de otro tipo	Other requirements Autres exigences Weitere Anforderungen Otras prescripciones	Anforderungen an andere Baustoffe Prescripciones para otros tipos de materiales	
15	16	17	18	19	20	21
1 E 200 (sometimes 350)	E 150-180	Min. 90 kg/m <sup>3</sup>	7 day compressive strength: ≥ 3,0 N/mm <sup>2</sup> (mix design)	Frost-thaw durability (for materials with porous particles or cohesive constituents)		15 mm under 4 m straightedge
2 Lean concrete: 200		Lean concrete: 4 to 6%	6 N/mm <sup>2</sup> + 2x standard deviation	Surface regularity: 10 mm under 3 m straightedge	SR Unbound crushed stone: 200 mm Plate bearing test: 110 N/mm <sup>2</sup>	15 mm under 3 m straightedge
3 200-250		M 6-8%	M Compressive strength at 7 days: ≥ 1,8-3,5 N/mm <sup>2</sup>	R M Frost resistance after 28 days	R M Compaction	R M Unevenness max. 20 mm ± 20 mm from true level
4 Cement-treated gravel: 150	Cement-treated gravel or sand: 150	100-120 kg/m <sup>3</sup>	Compressive strength: 5-10 N/mm <sup>2</sup>	Compaction		Max-number of irregularities at a random section 100 m long: Size of irregularity: M and MR SR S 10 mm 1 10 7,5 mm 3 10 6 mm 6 - 5 mm 15 -
5 120-250	Min. 120	Determined by laboratory tests (normally min. 4%)	OC 4 N/mm <sup>2</sup> at 7 days	Gravel: Dmax = 64 mm (45 mm) Humus content must be checked Mixing in place and in plant is allowed	Ground blast furnace slag can be used as binder up to 70%	Upwards 10 mm Downwards 20 mm 20 mm under 5 m straightedge
6 Related to design traffic, subgrade and type of pavement. Vibrated lean concrete: 120-220 Hydraulic binder treated base: 150-220	Seldom used	3,5 to 8%, according to required strength and construction process	Vibrated lean concrete: splitting characteristic strength: ≥ 2 N/mm <sup>2</sup> at 28 days Hydraulic binder treated base: tensile strength: ≥ 1,5 N/mm <sup>2</sup> at 360 days	Vibrated lean concrete: ≥ 3% air content		
7 150-200	N	150-220 kg/m <sup>3</sup>	8-15 N/mm <sup>2</sup>	Improved frost-resistance: 100 freezing and thawing cycles Testing also in NaCl solution (1%)		Max. 15 mm (transverse) Max. 10 mm (longitudinal) under 4 m straightedge
8 R Cement bound: 150 Cement treated: 150 Bituminous: 100 Cement bound or treated if there is no antifrost-layer: 200-250	R Bituminous: 80 or without subbase on an antifrost-layer Cement bound or treated if there is no antifrost-layer: 150-200	R Cement bound: > 3,0% Cement treated according qualification test	R Cement bound: 9-12 N/mm <sup>2</sup> at 28 days Cement treated: 6 N/mm <sup>2</sup> at 28 days (only for determining the binder content)	R Degree of compaction: > 98% Proctor Frost test: length variation ≤ 1% Notching of the subbase Cement bound: grading curve mixed in plant Cement treated: no grading curve mixed in place or in plant	R Bituminous: grading curve; min. binder content; percentage of voids; degree of compaction Unbound granular: grading curve; degree of compaction; > 100/103% deformation modulus; > 120 resp. > 100 MN/m <sup>2</sup>	R Cement bound or treated: ≤ 15 mm Bituminous: ± 10 mm Gravel and crushed stone: ≤ 20 mm under 4 m straightedge
9 A Cement bound: 150 (on granular capping: 150 to 600)	A Cement bound: 150 (on granular capping: 150 to 600)	R > 160 kg/m <sup>3</sup>	R > 10 N/mm <sup>2</sup> at 7 days	R Density: 95% of density of cubes compacted to refusal Granulated slag blends: slag < 65% Pfa blends: pfa < 50%	A Granular capping layer to obtain minimum 15% CBR	+ 10-30 mm from true level
10 R Crushed stone, sand and gravel treated with cement: 200	R Sand and gravel treated with cement: 150	R 4%	R 4,0-7,0 N/mm <sup>2</sup> at 7 days	R Dry density Optimum moisture content	A Sand-gravel or pozzolana: thickness: 150-200 mm	R ± 10 mm
11 A M Lean concrete: 150-200 MR Sand-cement or lean concrete: 150-200	N (sand or granular material used)	R Lean concrete: 75-125 kg/m <sup>3</sup> N Sand-cement	R Lean concrete: cube strength at 7 days ≥ 3 N/mm <sup>2</sup> Sand-cement: cylinder (Proctor) strength at 28 days ≥ 5 N/mm <sup>2</sup>	R Lean concrete: ratio sand/coarse aggregate 1:1-1:3 A Lean concrete: ratio fly ash/cement ≤ 1 crushed masonry > 4 mm	R Granular materials (e.g. slags, crushed concrete): see ASTM Standard 1990+ (grading, <math>C_{br}</math> crushing value) A Non-erodable materials only X Erodable materials	15 mm under 3 m straightedge
12 Gravel or sand: 150-180	Gravel or sand ≥ 120	R Min. 3% Normally 5-7% Mix proportioning required	5 N/mm <sup>2</sup> at 7 days	R Freeze/thaw testing 100% Mod. Proctor Max. particle size: 37,5 mm Materials < 75 µm (cement + filler): min. 10%		10 mm under 3 m straightedge ± 20 mm from true level
13 A Lean concrete: 150	A Cement bound granular material including soil-cement	A, MR 6% ± 1%	A, MR Mean comp. strength Cylinders Ø 150 x 300 mm 7 days ≥ 6 N/mm <sup>2</sup> 28 days ≥ 8 N/mm <sup>2</sup>	A MR Min. cement content: 110 kg/m <sup>3</sup> Max dry density (lab.) BS 1924-Test 5 Field density: ≥ 98% dmax Thickness: ± 15 mm	A SR Granular material: 150-200 mm	± 10 mm under 3 m straightedge
14 R Vibrated lean concrete: 150 Cement treated base (erosion-resistant): 150		R Vibrated lean concrete: min. 140 kg/m <sup>3</sup> Cement treated base: min 5%	R Either 8 N/mm <sup>2</sup> at 7 days or 12 N/mm <sup>2</sup> at 90 days	R Vibrated lean concrete: fraction passing through 0,016 mm sieve > 250 kg/m <sup>3</sup> w/c = 0,75-1,50 Use of air-entraining agents compulsory	R SR Unbound granular subbase, 200 mm, if CBR of subgrade < 10	R Vibrated lean concrete: between 0 and - 30 mm from true level 6 mm under 3 m straightedge Cement treated base: between 0 and - 1/5 thickness from true level 10 mm under 3 m straightedge
15 150		About 4,5%	10 N/mm <sup>2</sup> (Modified Proctor)			
16 R 150-300 (depending on soil bearing capacity)	R 150-200	R 3-9% according to soil type Min. 60 kg/m <sup>3</sup>	7 days: 2-4 N/mm <sup>2</sup>	Frost-thaw		Max. difference from true level: 20 mm 15 mm under 4 m straightedge

JOINTS / JOINTS / FUGEN / JUNTAS

Transverse contraction joints / Joints de retrait transversaux / Querschnittsfugen / Juntas transversales de contracción					Transverse expansion joints / Joints de dilatation transversaux / Querraumfugen / Juntas transversales de dilatación				
Spacing (i) unreinforced pavement (ii) reinforced pavement  Ecartement (i) béton non armé (ii) béton armé  Abstand (i) unbewehrt (ii) bewehrt  Separación (i) pavimento en masa (ii) pavimento armado  m	Reduction of section  Réduction de la section  Querschnittsschwächung  Reducción de espesor  mm or %	Construction method  Méthode d'exécution  Herstellungsverfahren  Método de ejecución	Type of sealer  Nature du produit de scellement  Art der Fugenfüllung  Tipo de producto de sellado	Sealing groove (i) width (ii) depth  Gorge de scellement (i) largeur (ii) profondeur  Fugenspalt (Aufwältung) (i) breite (ii) tiefe  Surco de sellado (i) ancho (ii) profundidad  mm	Spacing  Ecartement  Abstand  Separación  m	Width  Largeur  Breite  Ancho  mm	Type of filler  Nature du produit de scellement  Fugeneinlage  Tipo de material de relleno	Type of sealer  Nature du produit de scellement  Fugenfüllung  Tipo de producto de sellado	Sealing groove (i) width (ii) depth  Gorge de scellement (i) largeur (ii) profondeur  Fugenspalt (i) breite (ii) tiefe  Surco de sellado (i) ancho (ii) profundidad  mm
22	23	24	25	26	27	28	29	30	31
1 (i) 25 x slab thickness, max. 6,0; usually 5,5 (ii) not used	20-25% Usually ≥50 mm for 22 cm	Usually sawing	E Bituminous or neoprene	(i) 8 (ii) 20 (bituminous sealer) but usually joints, 2-3 mm wide, are left unsealed	Only at bridges (at least 2 at each side)	20	Wood	Bituminous or neoprene	(i) 20 (ii) 30
2 (i) 5 to 6	33%	Sawing	Hot poured	(i) 10 (ii) 30	A Only at special locations	20	Wood	Hot poured	(i) 30 (ii) 30
3 (i) 4-6	About 25%	Sawing	M Sealing mastic Modified hot asphalt	(i) 8 (ii) 10-15					
4 (i) 5 (ii) Only at day stops, etc.	25-30%	Sawing, maximum width 3 mm	Joints are not sealed	N	Only at special locations				
5 (i) 5	25-33%	Sawing	E	(i) 10 (ii) 25	A	16	E E.g. bituminous chipboard	E	(i) 20 (ii) 40
6 R (i) variable: 4-5,5; average: 5 (ii) not used	OC 20-25%	R Sawing P Wet-formed for low traffics	OC Elastomer-modified asphalt mastic, according to US Federal Specifications	(i) ≥5 (ii) ≥25	Only at special locations	10-15 CRC: 500, asphalt concrete with rubber aggregates	R Compressible material: expanded polystyrene, wood,...	OC Elastomer-modified asphalt mastic, according to US Federal Specifications	(i) 10-15 (ii) >5
7 (i) 20-23 x thickness (without dowels) 24-25 x thickness (with dowels) (ii) N	R 25-30% (without dowels) 30-33% (with dowels)	M, MR: sawing SR: vibrated	Bituminous	R (i) 12-20 (ii) ≥30	Every 10 transverse joints	≥20	OC E.g. wood Compressibility under a compressive stress of 5 N/mm <sup>2</sup> ≥50% Redeformation ≥50%	Bituminous or compressible filler	R (i) ≥20 (ii) 30-40
8 R (i) 4-6 5,0 as a rule permitted; 25 times thickness (ii) not used as a rule	R 25-30%	M, MR: sawing SR: sawing or vibrated	R Bituminous compound or plastic or rubber inserts	R (i) 8-15 depending on the crack width (ii) 25-35 depending on the sealing groove width	R Only at bridges but at least two to at every side	R Thickness of the joint filler: M,MR: 18 SR: 13	Softwood	Bituminous compound	R (i) 2 more than the filler thickness (ii) 1,5 times width
9 A (i) 5 or 6 with limestone (ii) 22 to 30 dependant on reinforcement and slab thickness	R D/4 to D/3	R Sawing or wet-formed (for winter work)	OC 1) Pitch/PVC hot-poured 2) Polysulphide cold-poured 3) Compression seals 4) Expanding cork	R (i) 13 (ii) 11 15 2) 13 3) 25 4) 50 to 60	A URC: 60 (if thickness ≥ 225 mm) 40 (if thickness < 225 mm) JRC: 66 to 90	R 25	OC Flexible cellular board or polyethylene foam	OC 1) Pitch-PVC hot-poured 2) Polysulphide cold-poured 3) Compression seals 4) Expanding cork	R (i) 30 (ii) 1) 25 2) 20 3) 40 4) 40
10 A (i) 4-7	R 25-30%	R Sawing	A Hot or cold poured sealing compound	A (i) 5-8 (ii) 30 including filling material	A Only at special locations	R 20	A Wood or other compressible material	A Hot or cold poured sealing compound	A (i) 20 (ii) 20-25
11 A (i) 3,50-5,00	R 33%	R Sawing or wet formed	R (if sealed) sealing compound	A (e.g. (i) 8 (ii) 20)	A Only at bridges	A (e.g. 10-30)	A M Neoprene MR/SR Softwood or prefoam	A MR/SR Sealing compound	A (e.g. (i) 10-30 (ii) 12-30)
12 R (i) 5-7 (ii) ≤20 (normally not used)	33%	R Sawing Normally 3 mm wide sawcut, unsealed	R When used: Bituminous compound or two components elastomeric sealant	R When used: (i) 8-10 (ii) 30	R Only against bridges and other special locations	R 20	R Preformed neoprene or other compressible materials	R Bituminous materials approved for sealing	(i) 20 (ii) 30
13 R M, MR (i) 4-5 (ii) not used	R M, MR 25-33%	R M, MR Sawing	R M, MR Hot poured sealing compound or mastic	R M, MR (i) 7-12 (ii) 25-35	A M, MR Only at special locations, e.g. near bridges, transition to other types of pav.	R M, MR 10-15	E M, MR Wood with bituminous compound or other	R M, MR Hot poured sealing compound or mastic	R M, MR (i) 7-12 (ii) 25-35
14 (i) 5 with dowels (M) Max 4 (1:6 skew) without dowels (MR, SR) (ii) Not used	R ≥25% slab thickness	R Sawing	R Hot-applied bituminous sealants or cold-applied two-components sealants (polysulphide based) or preformed neoprene profiles	R Hot-applied sealants (i) 7-10 (ii) 30-60 Cold-applied sealants: (i) 10-15 (ii) 30-50 Preformed neoprene profiles: (i) 4-8 (ii) 30-50	R Only at special locations (bridges and curves with radius <200 m)	R 15-18	R	R Hot-applied bituminous sealants or cold-applied two-components sealants (polysulphide based)	R (i) 20 (ii) Min. 30
15 (i) 5		R Sawing		(i) 8-10 (ii) 30	N	N	N		
16 (i) 5 (ii) generally not used		R Sawing	R Rubber bitumen	(i) 6-8 (ii) 20	Only at special locations	12-19	Synthetic material or wood		(i) 12-19 (ii) 25



JOINTS / JOINTS / FUGEN / JUNTAS

Load Transfer at Transverse Joints (i) Dowel diameter (ii) length (iii) spacing Dispositifs de transfert des charges aux joints transversaux (i) Diamètre (ii) longueur (iii) écartement des goujons Lastübertragungsmittel bei Querfugen (i) Dübel Durchmesser (ii) Länge (iii) Abstand Dispositivos de transmisión de carga en juntas transversales (i) Diámetro de los pasadores (ii) longitud (iii) separación		Longitudinal / Longitudinaux / Längsfugen / Longitudinales					
Contraction joints Joints de retrait Scheinfugen Juntas de contracción	Expansion joints Joints de dilatation Raumfugen Juntas de dilatación	Sawn (i) width / (ii) depth Sciés (i) largeur / (ii) profondeur Geschnitten (i) breite / (ii) tiefe Serradas (i) ancho / (ii) profundidad mm	Other types / Autres types / Andere Fugenausführungen / Otros tipos		Tie bars (i) diameter (ii) length (iii) spacing Barres d'ancrage (i) diamètre (ii) longueur (iii) écartement (i) Ankerdurchmesser (ii) -länge (iii) -abstand Barras de unión (i) diámetro (ii) longitud (iii) separación mm	Type of sealer Nature du produit de scellament Fugenfüllung Tipo de producto de sellado	Sealing grooves (i) width (ii) depth Gorge de scellement (i) largeur (ii) profondeur Fugenspalt (i) breite (ii) tiefe Surco de sellado (i) ancho (ii) profundidad mm
			Type Description du joint Art Tipo	(i) Width / (ii) Depth (i) Largeur / (ii) Profondeur (i) Breite / (ii) Tiefe (i) Ancho / (ii) Profundidad mm			
32	33	34	35	36	37	38	39
1 (i) 26 (ii) 500 (iii) Slow lane: 11 dowels Overtaking lane: 7 dowels	(i) 26 (ii) 500 (iii) Slow lane: 11 dowels Overtaking lane: 7 dowels	(i) 2-3 (ii) 25-30% of slab thickness	Construction joint	(i) 2-3 (ii) E	(i) 14 steel group IV, V 20 steel group I (ii) 700 steel group IV, V 1000 steel group I	E Bituminous or neoprene	(i) 8 (ii) 20 (bituminous) 40 (neoprene)
2 (i) 25 (ii) 600 (iii) 300	(i) 25 (ii) 600 (iii) 300	(i) 4 (ii) 70	Construction joint Keyed		(i) 12 (ii) 1000 (iii) 750	Hot poured or cold poured or neoprene	Hot and cold poured sealers: (i) 7 (ii) 30 Neoprene: (i) 4 (ii) 35
3		(i) 3 (ii) Min. 48				M Sealing mastic Modified hot asphalt	M (i) 8 (ii) 10-15
4 (i) 25 (ii) 600 (iii) 300 Dowels are coated against friction and corrosion Undowelled joints also used		(i) Maximum 3 (ii) 25-30%			(i) 12 (ii) 1000 (iii) 1000 Middle part coated against corrosion	Joints are unsealed	N
5 (i) min. 25 (ii) 500 (iii) 270-300	(i) 25 (ii) 500 (iii) 270-300	(i) 3-4 (ii) 25-33% thickness	Wet-formed joints (insertion of plastic strip)	Depth: 25-33% thickness	(i) 10 (ii) 800 (iii) 1000	E	E
6 R (i) 20-30 according to thickness (ii) > = 500 (iii) 300 (12 dowels per joint concentrated under wheel tracks)		OC (i) = < 8 (ii) 20-25% according to slab thickness	P Wet-formed joint created by the slipform paver	OC (i) 4-5 (ii) 20% slab thickness usually, 40-50	R (i) ≥ 10 (ii) 600 (iii) 750	OC Elastomer-modified asphalt mastic, according to US Federal Specifications	(i) ≥ 5 (ii) ≥ 25
7 (i) 25-28 (ii) 500 (iii) 300-600	(i) 25-28 (ii) 500 (iii) 300-600	R (ii) 35%	Wet-formed (plastic band filler)	(i) OC (ii) 35%	(i) ≥ 14 (ii) ≥ 600 (iii) ≤ 1200 in straight sections; closer in curves	Sawn joints: bituminous Wet-formed: plastic band filler	
8 R (i) 25 mm (ii) 500 mm (iii) M,MR: in the wheel tracks 250 mm; between the tracks and in the overtaking lane 500 mm. SR and hard shoulder: 500 mm or none	As in contraction joints	R (i) 6 (ii) 40-45% of slab thickness	P Drawn	(i) 0 (ii) 0	R (i) M,MR: 20 mm SR: 16 mm (ii) M,MR: 800 mm SR: 600 mm (iii) 3 each slab	R Bituminous compound or plastic or rubber inserts	R (i) 6 (ii) 10
9 R (i) Slab ≥ 240 mm thick 25 > 240 mm thick 20 (ii) 400 (iii) 300	R (i) Slab ≥ 240 mm thick 32 < 240 mm thick 25 (ii) 600 (iii) 300	P (i) 5 (ii) 1/4 to 1/3 slab thickness	1) Wet-formed 2) Butted	R (i) 5 (ii) 1) D/4 to D/3 2) 25 min.	R (i) 12 (ii) 1000 (iii) 600	OC Polyethylene foam strip or hot-poured compound or cold- poured compound or cork	R (i) 5 (ii) 25 min.
10 A (i) 22 (ii) 600 (iii) A	A (i) 30 (ii) 600 (iii) A	A (i) 5-8 (ii) 25-30% slab thickness	A Plastic strip inserted into the fresh concrete	A (i) 2 (ii) 0,25-0,30 thickness	R (i) 16 (ii) 800 (iii) 750	A Hot or cold poured sealing compound	R (i) 5 (ii) 30 including filling material
11 A (in general (i) 25 mm (ii) 500 mm (iii) 300 mm)	A (in general (i) 25 mm (ii) 500 mm (iii) 300 mm)	R (i) 3 (ii) 40%			A (in general (i) 16 mm (ii) 800 mm (iii) 3 per slab	A (e.g. sealing compound or massive rubber insert)	A (e.g. (i) 8 (ii) 20)
12 R (i) Min 25 (R) (ii) Min 400 (R) (iii) Normally 400	R (i) Min 25 (ii) Min 400 (iii) 400	(i) 3 unsealed (normal) or 3-5 sealed (ii) 1/3 slab thickness	R Construction joint		R (i) Min 10 mm (ii) Min 500 mm (iii) 1000 mm	When used: bituminous compound	When used: (i) 3-5 (ii) 1/3 slab thickness
13 R M, MR (i) 25-32 (ii) 350-500 (iii) 300	R M, MR (i) 25 (ii) 500 a 600 (iii) 300	R M, MR (i) 7-12 (ii) 25-33	P Preformed	E	R M, MR (i) 12 (ii) 1000 (iii) 700-800	R M, MR Bituminous compound	R M, MR (i) 7-12 (ii) 25-35
14 R (i) 25 (ii) 500 (iii) 300 at slow lane; 600 at overtaking lane	R (i) 25 (ii) 500 (iii) 300 at slow lane 600 at overtaking lane	R (i) N (ii) Min. 1/3 slab thickness			(i) 12 (ii) 1000 (iii) 1000		(i) 10 (ii) 30
15 (i) 20 (ii) 600 (iii) 300	N	(i) 3 (ii) 1/3 slab thickness			(i) 12 (ii) 1000 (iii) 1000		(i) 10 (ii) 30
16 (i) 22 (ii) 500 (iii) 500	(i) 22 (ii) 500 (iii) 500	(i) 3 (ii) 30	Between concrete and bituminous pavement	(i) 10 (ii) 21	(i) 14 (ii) 500 (iii) 1000	Rubber bitumen	(i) 6-8 (ii) 20

REINFORCEMENT / ARMATURES / BEWEHRUNG / ARMADURAS			CEMENT / CIMENT / ZEMENT / CEMENTO		CONCRETE / BÉTON / BETON / HORMIGÓN					
Continuous reinforcement / Armature continue Durchgehende Bewehrung / Armadura continua	Jointed reinforced pavements Specified or permitted	Type used	Restrictions governing use including Pfa	Strength specified / Résistance exigées / Vorgeschriebene Festigkeit / Resistencia especificada		Type of specimen and test method	Frequency of testing			
Specified or permitted % for each direction	Method of steel placement	Désignation	Restrictions particulières, y compris cendres volantes	Flexural	Other	Type des éprouvettes et méthode d'essai	Fréquence des essais			
Spécifiés ou permis pourcentage dans chaque direction	Méthode de placement des armatures	Verwendete Zementart	Besondere Vorschriften, einschließlich der Verwendung von Flugasche	A la flexion	Autres	Prüfkörper und Prüfverfahren	Häufigkeit der Prüfungen			
Vorgeschrieben oder gestattet; % für jede Richtung	Art der Bewehrungsverlegung	Tipo utilizado	Limitaciones en su empleo, Incluso cenizas volantes	A flexotracción	Otros tipos	Tipo de probeta y método de ensayo utilizado	Frecuencia de ensayos			
Especif. o permitidos; % de armadura en cada dirección	Método de colocación de las armaduras			N/mm <sup>2</sup>	N/mm <sup>2</sup>					
40	41	42	43	44	45	46	47	48		
1	N		Ordinary Portland cement PZ 275 (H) containing max. 20% slag	Blaine < 3500 cm <sup>2</sup> /g, 28 days flexural strength ≥ 6,0 N/mm <sup>2</sup> Pfa not used	Min. 5,5 at 28 days	Compressive Min. 40 upper layer Min. 35 lower layer	Compressive: 20 cm cubes, 7 days under water; 21 days air, 20 °C, 65% rel. humidity Flexural: 12 x 12 x 36 cm beams, storage under water, centrepoint loading	One set of 3 per 20000 m <sup>2</sup>		
2	Longitudinal 0,7% (0,67%) Transverse 0,08%	On metallic supports	None	None		Compressive 55 + 2 x standard deviation	Cores: section 100 cm <sup>2</sup> height 10 cm	1 core per 1000 m <sup>2</sup>		
3			Portland cement		Min. 4,5 at 28 days	P M Compressive strength 24-32 Tensile strength 2,3	R M Beams 15 x 15 x 70 cm or cylinders Ø 15 x 30 cm	R M 1 every 600 m <sup>3</sup>		
4	Longitudinal: 0,6-0,9 Transverse: 0,2-0,3	OC	N	Low alkali		N				
5	A	A	A	Ordinary Portland (Ground blast furnace slag allowed partly)	Pfa not used	7 at 28 days (91 days when slag is used)	Compressive 55 70 for wear resistant concrete	According to ISO 4012 and ISO 4013	Flexural strength: 1 specimen every 1000 m <sup>2</sup> , min. 3 per day Compressive strength: 1 specimen every 500 m <sup>2</sup> , min. 9 per day	
6	R Logitudinal: 0,67 (reinforcing bars) 0,3 (notched strips) P Transverse: related to construction method	OC	X	CPA and RPJ, class 45 P Others	R Cement according to French standards P Addition of Pfa permitted	Average flexural strength ≥ 5	R Characteristic splitting strength ≥ 2,4	Flexural strength: prismatic specimens, 20 x 20 x 80 cm (laboratory previous tests) Splitting strength: cylindrical specimens, Ø 15 x 30 cm (laboratory and control tests)	R 1 test every 300 m <sup>3</sup> Minimum: 2 tests per day	
7	N Not used			Portland cement PZ 35 PZ 40 PZ 45	Cement with the addition of ashes		Splitting tensile strength: 2,7 - 3,0 - 3,3 - 3,7 - 4,0 Compressive strength: ≥ 25 - ≥ 35 (5% quantile in both cases)	Cubes 15 x 15 x 15 cm Cores Ø 10 cm	B35: 1 cube every 40 m <sup>3</sup> , max. 6 per day B46: 2 cubes every 40 m <sup>3</sup> , max. 12 per day	
8	N Not used			R Z 35 (Portland and Iron- Portland cement) Z 45L (Blast Furnace cement)	Pfa blended cements not used R Cement has to meet the Ger- man DIN 1164 and the require- ments (fineness of grinding < 4000 cm <sup>2</sup> /g, EN 196-6, set behaviour) of the Federal Mi- nistry of Transport	R M, MR: 5,5 SR: 4,5 at 28 days	R Compressive strength M, MR: average 40 min. 35 SR: average 30 min. 25 at 28 days	R Flexural: beams 15 x 15 x 70 cm Compressive: cubes 20 x 20 x 20 cm or 15 x 15 x 15 cm	Specified for each project	
9	A Surface slabs: 0,6 (longitudinal) Roadbase slabs: 0,4 (longitudinal) 12 mm at 600 cs (transverse)	OC	A	4,2 to 6,5 Varies with slab thickness for a given traffic	Ordinary Portland (OPC) or OPC with ground granulated slag (OPC/ggbs) or OPC with Pfa (OPC/Pfa)	OPC/ggbs: ggbs < 50% OPC/Pfa: Pfa 15 to 35%	N	R Compressive 40	R Cube compression test BS 1881 Part 116	1 to 3 series of 3 specimens every day
10	R 0,69	R	Manual placement on supports fixed to subbase layer	Not used	R Portland 32,5 Pozzolanic 32,5	R Initial setting time > 2 hours at 30 °C C A content ≤ 8%	R ≥ 5,5 at 28 days	R Compressive strength: ≥ 50 at 28 days Splitting strength: ≥ 2,8 at 28 days	R Flexural: beams 15 x 15 x 60 cm Compressive: cubes 15 x 15 x 15 cm Splitting: cylinders Ø 15 x 30 cm	M, MR: min. 3 series of beams per day (min. 3 beams per series) SR: min. 2 series of beams per day (min. 2 beams per series)
11	A 0,67 longitudinal	OC	Not used	Not used	R Portland, Portland Fly Ash or Blast Furnace Slag complying with NEN 3350	X Blast Furnace Slag Cement in top layers of M and MR	N	A M: in general, B45 (characteristic cube strength at 28 days: 45) MR, SR: in general, B35	R Cubes 15 cm Compressive strength	Cubes: variable Cores: every 50 m
12	Normally not used If used: Longitudinal 0,75 of cross-section (C 40 concrete) Transverse 0,2 of cross- section (C 40 concrete)	Placed in centre of cross-section	Not used	Not used	Ordinary Portland Cement or modified Portland Cement (20% Pfa) or Offshore Cement (P30-4A)	R Min. 65% Portland clinker Max. 10% microsilica	Variable R: min. 4,3	Compressive strength: variable, depending on traffic (studded tires) 45-75 at 28 days Normally, 75-90 R: min. 40	10 cm cubes or Ø 15 x 30 cm cylinders or 15 x 15 x 75 cm beams (third point loading)	R Flexural: only in qualification test Compressive: qualification test and at work start and every 1000 m <sup>2</sup> or once a day
13	N	N	N	Ordinary Portland cement (CPN) Portland with Pfa (CPC)	R CPN 30-40 CPC 30	R M, MR 4,0-4,5 at 28 days mix design and control purposes	R E cylinders > ø1 cubes > ø2 Control purposes only; ø1 and ø2 are fixed according to lab. study formulation	R Beams 15 x 15 x 55 cm Third point loading	R 1 pair of cubes per 600 m <sup>2</sup> or 6 per day 1 tested at 7 days 1 tested at 28 days	
14	R Longitudinal reinforcement amount depending on concrete strength: HP-45 concrete: 0,7	N	Not permitted	Types I, II, III, IV, V (UNE 80 301 Standard)	R Mixes in plant of cement and active additions not allowed Initial setting time, min. 2 h (1 h when air temperature > 30 °C)	R HP-45 concrete: 4,5 (M, MR) HP-40 concrete: 4,0 (M, MR, SR) HP-35 concrete: 3,5 (MR, SR) Characteristic strength at 28 days (80 days when type V cements are used)	N	R Beams 15 x 15 x 60 cm Third point loading	R Flexural: 9 specimens per day Compressive: 12 specimens per day Splitting: 9 specimens per day	
15	Not used			Special cement	Pfa not used Silica fume not used	4,8 6 7	Splitting strength on cores		3 cores every 3000 m <sup>2</sup>	
16	0,5-0,6	Inserted automatically in the middle of slab thickness	N 2-5	Portland cement	No use of other cement types	5 for concretes with 300 kg/m <sup>3</sup> cement content 5,2 for concretes with 350 kg/m <sup>3</sup> cement content	Compressive 34 for concretes with 300 kg/m <sup>3</sup> cement content 38 for concretes with 350 kg/m <sup>3</sup> cement content	Compressive: cubes, 12 x 12 x 12 cm Flexural: beams, third-point loading method	1 test every 5000 m <sup>2</sup>	

CONCRETE / BÉTON / BETON / HORMIGÓN

FINE AGGREGATE / GRANULAT FIN / FEINE ZUSCHLAGE / ARIDO FINO

Max. water / cement	Minimum cement content specified	Workability (test method and frequency)	Mix proportions (by weight)	Air entrained concrete / Béton à air occlus / Luftporenbeton / Hormigón con aire occludo		Grading, if specified: percent by weight passing each sieve	Notes on fine aggregate, types, frequency of testing, etc.
				% air entrained (minimum and maximum)	Method of determining air content and frequency		
Max. eau / ciment	Teneur minimale en ciment prescrite	Maniabilité (méthode d'essai et fréquence)	Composition du mélange (en poids)	% air occlus (min. et max.)	Méthode de détermination de la teneur en air et fréquence des essais	La granulométrie si celle-ci est prescrite en % passant à travers chaque tamis	Notes relatives aux granulats, nature, fréquence des essais, etc.
Max. Wasserzementwert	Vorgeschriebener Mindestzementgehalt	Verarbeitbarkeit (Prüfverfahren und -häufigkeit)	Mischungsverhältnis (nach Gewicht)	geforderter Luftgehalt in % (min. und max.)	Verfahren und Häufigkeit der Luftporenprüfung	Wenn vorgeschrieben, Korngröße/verteilung: Durchgang durch Siebe in Gew % / Masse %	Bemerkungen zu feinen Zuschlägen, Art, Häufigkeit der Prüfungen usw.
Max. agua / cemento	Contenido mínimo de cemento especificado	Trabajabilidad (método de ensayo y frecuencia)	Proporciones de la mezcla (en peso)	% aire occludo (mínimo y máximo)	Método de determinación del contenido de aire occludo y frecuencia	Granulometría especificada: porcentaje en peso pasando por cada tamiz	Otras prescripciones sobre el árido fino, tipo, frecuencia de ensayos, etc.
49	50	51	52	53	54	55	56
1 Usually <0,43	A	Verdichtungsmass. (compaction degree), daily	N	3,5-5,0	Air-pressure meter, min. 3 times/day Microscopic determination of spacing factor at start of work	N	O/1 and 1/4 or O/4 with guaranteed grading Grading daily Sand for upper concrete must contain at least 1/3 siliceous constituents
2 0,45	375 kg/m <sup>3</sup>			None	None	None Percent passing 0,080 mm sieve: <5%	
3 M 0,45	N	N	N Per m <sup>2</sup> : cement 370 kg, water 150-160 l, 0/8 630-690 kg, 8/16 460-470 kg, 16/32 650-700 kg, air entraining agent	R M 3,5-6,5	R M Pressure type air meter; min. 1 every 2 hours		M Grading: 1 test every 1000 m <sup>3</sup>
4 0,40 Alternatively 0,25 with superplasticizer, increased amount of microsilica, and no air entrainment	325 kg/m <sup>3</sup> Alternatively fly ash, and reduced cement content			4-7	Microscopical evaluation of hardened concrete	N	N
5 0,42	350 kg/m <sup>3</sup>	Slump test and German flow table, min. 1 per day	E	2-4 No specified for wear resistant concrete	Air meter pressure method (ISO 4848)	E	Grading curve Specifications on content of: organic matter, silt
6 N	R 300-350 kg/m <sup>3</sup> P ≥ 250 kg/m <sup>3</sup>	Laboratory previous tests: workability meter LCL, 15-50 sec (NFP 18 452 Standard) Control tests: slump test ≤ 6 cm (NFP 18 451 Standard) Usually 1 test every 500 m <sup>3</sup> , min. 2 tests per day Reinforced control: 1 test every 100 m <sup>3</sup> , min. 4 tests per day	N	R 3-6	Pressure type air meter (NF 18 353 Standard) Usually, 1 test every 500 m <sup>3</sup> , min. 1 test per day Reinforced control: 1 test every 100 m <sup>3</sup> , min. 4 tests per day	According to NFP 18 101 Standard	Fineness modulus ± 0,3 Friability <15 (NFP 18 576 Standard) Cleanliness ≤ 0,10 (methylene blue test, NFP 18 592 Standard)
7 R Max. 0,46 without air entraining agent Max. 0,55 with air entraining agent	300 kg/m <sup>3</sup>	A Walz test, min. 12 times per day	N	R 4-6	Pressure air meter every 100 batches Min. 1 per day	Standard grading curve (0-4 mm) 0,25 mm 5-8 0,50 mm 9-18 1,00 mm 18-28 2,00 mm 25-37 4,00 mm 35-47	Grading frequency: every 400 t (min. 1 per week)
8 Variable, depending on specified compressive strength	R Min. 300 kg/m <sup>3</sup>	Thaulow's drop table concrete tester and slump test at least once per day	According to DIN 1045 and ZTV Beton, based on preliminary tests	R Without plasticizers: average 4,0. Min. 3,5 With plasticizers: average 5,0. Min. 4,5	Air meter (pressure compensation method) R Once an hour	R According to DIN 1045 M, MR: 1 mm < 27% 2 mm < 30%	R Content of cement and fine aggregates <0,25 mm: max. 450 kg/m <sup>3</sup> Requirements according to DIN 4226, TL-Min-S18 and RG-Min-S18 Grading of fine aggregates ≤ 2 mm: once a day
9 R 0,5	R 300 kg/m <sup>3</sup>	R Slump test, 1 every 200 m <sup>3</sup> , min. 2 per day Vebe	N Based on trial mixes	R 5 ± 1-5 for 20 mm aggregate 4 ± 1-5 for 40 mm aggregate	Pressure type air meter, min. 6 per day (BS 1881 Part 106)	N	Not more than 25% of CaCO <sub>3</sub> in top 50 mm of slab
10 R 0,46	R 300 kg/m <sup>3</sup>	R Test method not specified When slump test is used, slump: 2-6 cm Workability tests performed every time a series of beams for control of strength is made	A Based on preliminary tests cement / water / aggregates 1 / 0,45 / 6	R 5 ± 1	Pressure type air meter (ASTM C231, UNI 6385), 1 per hour	N Based on preliminary tests	Sand equivalent >80, 2 tests per day Passing 0,075 mm ≤ 2%, 2 tests per day Moisture content: every 360 m <sup>3</sup>
11 R M, MR: 0,45 SR: 0,50 Airport runways: 0,42	N 330 kg/m <sup>3</sup>	Slump test: every 100 batches Compacting factor test: every day	A Preliminary tests according to NEN 5950	A Generally, 3-5	R According to NEN 5961 (displacement method) or NEN 5962 (pressure type air meter) 1 test every 40 m <sup>3</sup> , 3 per day	R According to NEN 5905	A River sand
12 R 0,50	R 330 kg/m <sup>3</sup>	R Consistency: Walz compaction test, once a day	Based on required preliminary tests	R 4-6 for ordinary concrete (C40) Air not specified for high strength concrete >65 MPa	Air meter pressure method At least 2 times per day	Not specified, but approval is required for each project	
13 R 0,45	R 320 kg/m <sup>3</sup> for OPC 340 kg/m <sup>3</sup> for OPC/ggbs or OPC/pfa	R Compacting factor (BS 1881 Part 103): 1 per 300 m <sup>2</sup> or 6 per day	R Continuously graded O / 37,5 According to laboratory preliminary tests	P 4-6	Air meter pressure method, 1 test every 200 m <sup>3</sup> , min. 2 tests per day	n.* 4 95-100 n.* 8 65-90 n.* 16 50-70 n.* 30 40-57 n.* 50 10-30 n.* 100 2-10 n.* 200 0-5	R Grading: 1-2 tests every 500 m <sup>3</sup> Sand equivalent: 2-4 tests every 500 m <sup>3</sup> Water content: 1 test per day
14 A Based on preliminary tests 0,42-0,45	R ≥ 325 kg/m <sup>3</sup>	R UNI 7163, 1 per hour	N Based on preliminary tests Fraction passing through 0,016 mm sieve ≤ 450 kg/m <sup>3</sup> (R)	R Max. 6 In frost areas, min. 4	Pressure-type air meter Every time a series of beams for control of strength is made	R 5 mm 90-100 2,5 mm 65-90 1,25 mm 45-75 0,63 mm 27-55 0,32 mm 10-30 0,16 mm 2-10 0,08 mm 0-5	R Siliceous fraction: min. 30% Sand equivalent: min. 75 (min. 80 in frost areas) Variation of fineness modulus: max. 5%
15 N	N	N		Depending on concrete strength 4,8 N/mm <sup>2</sup> : 5,5 6,0 N/mm <sup>2</sup> : 4,0 7,0 N/mm <sup>2</sup> : 3,5	Pressure type air meter: 2 tests per day 2 cores every 3000 m <sup>2</sup> for frost salt test and microscopic quality control	N	N
16 0,38-0,43	300-350 kg/m <sup>3</sup>		According to Swiss specification SIA 162/1989	4-6	Pressure type air meter, 5-8 times per day	According to Swiss specification SIA 162/1989	According to Swiss specification SIA 162/1989

COARSE AGGREGATE / GROS GRANULAT / GROBE ZUSCHLÄGE / ARIOO GRUESO			CONCRETE MIXING / FABRICATION DU BETON / HERSTELLUNG DES BETONMISCHGUTES / FABRICACION DEL HORMIGON			PAVING AND FINISHING / MISE EN PLACE ET FINITION / EINBAU / PUESTA EN OBRA Y ACABADO		
Separate sizes used	Grading, if specified: percent by weight passing each sieve	Notes on coarse aggregate, types, frequency of testing, etc.	Plant mixing. If specified, mixing time (seconds), type of mixer and minimum output	Truck mixing / Malaxage en camion / Transportbeton / Fabricación en camión hormigonera		Placing temperature minimum or maximum		
Différentes dimensions utilisées	La granulométrie si celle-ci est prescrite en % passant à travers chaque tamis	Notes relatives aux granulats, nature, fréquence des essais, etc.	Durée du malaxage (en seconds), type de malaxeur et débit minimal	Specified or permitted	Prescriptions	Air temperature	Concrete temperature	
Gebräuchliche Korngruppen	Wenn vorgeschrieben, Korngrößenverteilung: Durchgang durch Siebe in Gew. % / Masse - %	Bemerkungen zu groben Zuschlägen, Art, Häufigkeit der Prüfungen usw.	Mischenlage. Wenn vorgeschrieben: Mischzeit in Sekunden, Mischerbauart und Mindestleistung	Prescrit ou autorisé	Prescriptions	Température de l'air	Température du béton	
Tamaños utilizados	Granulometría especificada: porcentaje en peso pasando por cada tamiz	Otras prescripciones sobre el árido grueso, tipos, frecuencia de ensayos, etc.	Planta de fabricación. Tiempo de amasado especificado (segundos), tipo de hormigonera y rendimiento mínimo	Vorgeschrieben oder gestattet	Vorschriften	Lufttemperatur	Betontemperatur	
				Especificada o permitida	Prescripciones	Temperatura ambiente	Temperatura del hormigón	
						°C	°C	
57	58	59	60	61	62	63	64	
1	4/8, 8/16 and 16/22	N	Grading daily Los Angeles: max. 20 PSV: ≥0.50	Min. 60 s	X	R: ±5 P: -3	min. ±5, 10 at air temperature of -3 max. 25 in warm weather	
2	2/7 7/20 20/32	None	PSV: ≥0.50		Prohibited	None	Minimum 1	None
3	M 0/4 or 0/8 8/16 16/32	M > max. 10% < max. 15%	R  M Crushed Grading: 1 test every 1000 m <sup>3</sup>		M Not permitted	R  M Correlation with concrete temperature	R  M Min. 5 Max. 25	
4	N	N	N	Concrete mixed until uniform mix is obtained	X	N	Minimum: +5 Maximum temperature will not be included in specifications, but planning will demand spring or autumn work, avoiding both summer and winter	N
5	E Dmax normally ≤32 mm	E	Frost resistant, dense, durable Testing LA value, brittleness, particle shape, fracture value and grading curve	OC	Not permitted	Min. +5	Max. 30 after casting	
6	N	According to NFP 18 101 Standard	R Polished stone value: ≥0.55 (only for exposed aggregates) Cleanliness: ≤0.5 (NFP 18 591) Shape coefficient: ≤20 Los Angeles coefficient: ≤16 Wet micro-Deval: ≤15 (NFP 18 572) Soundness: <50% (NFP 18 593)	Type of mixer: N Mixing time: >30 sec (NFP 18 305 Standard) Certified mixing plants included in aptitude relation	X	R 5-30 P 0-5 with protection	R 5-30	
7	4, 8, 11, 16, 22, 32 mm	Standard grading curve: 8 mm 50-62 16 mm 72-80 32 mm 100	Every 400 t (min. 1 per day)	Mixing time: 60 s	Only when using concrete with superplasticizer	N	5-26 without protection With protection, air temperatures up to -5 or over 25 can be allowed, but concrete temperature must be always under 30	≤30
8	R Min. required: M, MR: 0/2, 2/8, >8 mm or 0/4, 4/8, >8 mm SR: 0/4, >4 mm Max. size: 16, 22 or 32 mm	According to DIN 1045	R M, MR: Aggregates >8 mm: min. 50% crushed stone Crushed stone content of combined grading: min. 35% Requirements according to DIN 4226, TL-Mix-StB, RG-Mix-StB Grading of aggregates >2 mm: once per week	R Mixing time will be specified in the new ZTV Beton-StB (91?): min. 45 s	X Exception: mixing of superplasticizers into the mixed-in-plant concrete	Temperature <+5 and >+25: special precautions are to be taken Temperature <-3 or continuous frost: works have to be stopped	R Min. +5 during the first 3 days Max. +30 when paved	
9	OC Normally 40-20 mm or 20-10 mm or 10-5 mm (for repairs)	N	Natural gravel, crushed rock to BS 822 or blastfurnace slag to BS 1047 or crushed concrete with quality requirements of BS 882	OC	P	N Main sles P Kerbs and channels	R Min. 3	R Max. 30
10	3	N Based on preliminary tests	R, A Soft or weathered particles: ≤1% Particles with alkali reactive elements: ≤1% L.A. coefficient/Micro-Deval/PSV according to type of finishing and traffic Frequency of testing: 1 per day	R Min. output 120 m <sup>3</sup> /hour	N	N	R Tmin=2 When 2-5, mixing water heated E Tmax	N 26,7
11	R According to NEN 5905	R According to NEN 5905 and the 'RAW Standard 1990'	A River gravel Crushed material complying to the 'RAW Standard 1990' in the top layer Frequency of testing: according to NEN 5905 and the 'RAW Standard 1990'	N	E According to NEN 3502	NEN 3502	R Minimum +4 (mean daily temperature) A (in general: no concreting in winter months)	N
12	Not specified, but approval is required for each project			N	N		Min. 2	N
13	R M, MR According to pretended grading Min. 3 separate sizes	N	R M, MR L.A. : ≤30 mm Max. size : ≤37.5 mm Organic content : <0.5% % pass n.° 200 : <1% Sand equivalent : >80%	R M, MR Batch type min. 60 m <sup>3</sup> /h	N	N	R M, MR 5-30 depending on humidity and wind	N
14	R Min. 2 fractions	N	R Maximum size: 40 mm or 1/2 layer thickness Los Angeles: max. 35	R Mixing time: N Type of mixer: batching plant Min. output to allow a paver advance of 60 m per hour	R Only in SR or when pavement surface ≤5000 m <sup>2</sup>	R Max. drum filling: 2/3 total volume	N Depending on air temperature and humidity, precautions must be adopted (E)	R 10-30
15	N			N About 80 s	N		Min. +5	
16	According to Swiss specification SIA 162/1989	According to Swiss specification SIA 162/1989	According to Swiss specification SIA 162/1989	Mixing time between 60-120 s Various types of mixers Min. output depending on the mixing type. (N)	P Seldom used		5-30	5-26

PAVING AND FINISHING / MISE EN PLACE ET FINITION / EINBAU / PUESTA EN OBRA Y ACABADO

Paving method currently used Méthode de construction normalement employée Gebrauchliche Einbauverfahren Método de puesta en obra utilizado normalmente	Type of final finishing or surface texture Nature de la finition ou de la texture de surface Art des Fertigstellens der Oberfläche, Strukturierung Tipo de acabado o de textura superficial	Restrictions on time for finishing Limites de temps pour l'exécution des travaux de finition Zeitbeschränkung für die Fertigstellung Restricciones en el plazo para la terminación	Method of dowel placement Méthode de placement des goujons Dübeleinbau Método de colocación de los pasadores	Is a super-smoother used for longitudinal finishing? Une poutra lisseuse oscillante est-elle employée pour améliorer l'uni? Verwendung eines Längsglättlers? ¿Se utiliza una maestra oscilante para mejorar la regularidad superficial?	Surface tolerance / Tolérance de surface / Oberflächentoleranzen / Tolerancia de acabado		Texture depth or skidding resistance requirements Profondeur de la texture ou prescriptions sur la resistance au glissement Anforderungen an die Texturhöhe oder an die Grifffigkeit Profundidad de la textura o prescripciones sobre resistencia al deslizamiento
					Maximum variation permitted Ecart maximal autorisé Höchstzulässige Unebenheiten Máxima irregularidad permitida	Method of evenness correction or financial penalty Méthode de correction de l'uni ou pénalité Verfahren zur Beseitigung von Unebenheiten bzw. finanzielle Abzüge Método de corrección de la regularidad superficial o penalizaciones	
65	66	67	68	69	70	71	72
1 Slipform paver or super-plasticized concrete	Longitudinal texture or exposed aggregate	Upper layer must be compacted within 1-2 hours and 3 hours after compaction of lower layer	Vibrated into the fresh concrete	Yes	3 mm under 4 m straightedge	Grinding or financial penalty	E
2 Slipform paver	Exposed aggregate finishing	2 hours after mixing	On metallic cradles or vibrated into the fresh concrete	Mainly	4 mm under 3 m straightedge	Financial penalty Grinding permitted	SFCI ≥ 0.45 SFCM ≥ 0.50 measured at 80 km/h
3 M Slipform paver	M Grooving of fresh concrete (brushing)	M Immediately		M Yes	R M 5 mm under 4 m straightedge ± 10 mm from true level	M Grinding	M Sand patch test: min. 0,80 Coefficient of longitudinal friction (v = 60 km/h)
4 Slipform paving	Exposed aggregate surface	N	Dowel cradles, unless the contractor's paver is equipped to place the dowels with sufficient accuracy	Yes	Maximum number of irregularities at a random section 100 m long, measured by Viograph Size ≥ M and MR SR 10 mm 0 0 0 7,5 mm 0 2 2 6 mm 2 3 3 5 mm 3 5 5 3 mm 8 15 15	Surface grinding	Skidding resistance ≥ 0,4 at 60 km/h on clean, wet pavement Reduction with 20 km/h increase of speed within the range 60-90 km/h: ≤ 0,1 Texture depth required: ≥ 1 mm
5 Slipform paver	Transverse brushing	Max. 2 hours from mixing	Automatically inserted or fixed on cradles	Yes	5 mm under 5 m straightedge	Diamond grinding or financial penalty	2-3 mm
6 OC Slipform paver	OC Transverse texturing or chemical stripping, related to traffic and short term maintenance	Texturing: < 30 min after spreading Chemical stripping: brushing is performed 24 to 48 hours after spreading, according to air temperature	R On cradles	Not recommended due to very variable results	Control with APL 25 or 72 Tolerances: 80% < 4, 90% < 8 and 100% < 13	Diamond grinding and/or financial penalty	Sand patch test: > 1,5 mm
7 M, MR, runways: slipform paver MR, SR: fixed form paver Concrete with superplasticizer in small works	Brushing		On baskets	No	Max. unevenness in mm under 4 m straightedge M MR SR Single value 8,0 9-10 11 Average value 2,5 3-4 5	Planning through milling	speed (km/h) > 80 < 80 < 60 SRT single value 55 55 50 average value 60 60 55 Text. depth, mm single value 0,80 0,30 0,25 average value 0,80 0,50 0,35
8 Predominantly used: slipform paver Rarely used: fixed form equipment	R Finishing float (smoother) and burlap or transverse brushing	N For finishing R For two-layer placing: top concrete must be placed one hour after compaction of the base concrete in warm, dry weather, and two hours after in cool, damp weather	Vibrated into the fresh concrete by a dowel setting unit	Yes R For M,MR	R Max. ± 20 mm from true pavement surface. M, M4: ≤ 4 mm under 4 m straightedge SR: ≤ 6 mm under 4 m straightedge	Grinding or financial penalty	Several test methods used Texture: sand patch test or outflow meter or laser Skidding resistance: skid resistance tester (SRT) or Stugarter Reibungsmesser (SRM)
9 OC Fixed form train Slipform paver	R Transverse brushing, with wirebrush	R Within 3 hours of mixing or 2 hours between 25 °C and 30 °C concrete temperature	OC Pre-positioned or inserted into bottom layer	N	R ± 6 mm from design level Max. number of irregularities in 300 m: 4 mm 20 (M,MR) 40 (SR) 7 mm 2 (M,MR) 4 (SR)	R Grinding or bump cutting and retexturing	R 0,65-1,35 mm on opening to traffic
10 R Slipform paver	A Transverse brushing Chemical stripping Porous asphalt concrete	N	A Manual placement on cradles	N	R 3 mm under 3 m straightedge For C/PCP with porous asphalt Concrete course (PCP): APL: CARP 25-25 over 100 m length ARAN: MAS < 3mm/m over 200 m length 5 mm under 3 m straightedge	N Financial penalty	N For PCP
11 Slipform paver	A In general: super smoother followed by transverse brushing	A In general: within 3 hours after mixing	OC In general, mechanical insertion	Yes	R MMR 5 mm under 3 m straightedge SR 15 mm under 3 m straightedge	A In general: grinding or removal of slabs(s)	R Skidding resistance at 50 km/h (86% slip) ≥ 0,52 A Texture depth (e.g. 0,7 mm)
12 Slipform paver most common	Transverse brushing Surface texturing required	R Within 2 hours of mixing In cold weather 3 hours	Normally, automatic dowel placement	Normally	R 4 mm under 3 m straightedge Max 15 irregularities > 3 mm per 10 m lane	Grinding or financial penalty	N
13 R M, MR Slipform paver	R M, MR Transverse or longitudinal brushing	R 2 hours	R Inserted into fresh concrete by vibration or installed on metal supports	N, A M, MR	R M, MR 3 mm under 3 m straightedge	N	R Texture depth (sand patch test): > 1 mm, min. 0,6 mm
14 Slipform paver	R Usually, longitudinal texture (brushed or grooved) Also admitted transverse texture (grooved) or chemical stripping (plus chipping if fraction of siliceous particles of fine aggregate < 30%)	R Max 1 hour (2 hours if slow setting cements or retarders are used, or under favourable weather conditions)	R Inserted into fresh concrete (usual) or on cradles	Yes	R For design speed ≥ 100 km/h: 3 mm under 3 m straightedge viograph coefficient: average value 6 dm/m For design speed < 100 km/h: 4 mm under 3 m straightedge viograph coefficient: average value 7 dm/m	R Grinding	R Sand patch test: 0,7-1 mm (min. value 0,5 mm) 2 checks per day (5 if one of the results is lower than 0,5 mm)
15 Slipform paver	N		Mechanical insertion	No	R 3 mm under 3 straightedge	Grinding	R Friction coefficient: 0,55 (special test method at 70 km/h, 17% slip)
16 Slipform paver Fixed form paver	Brushing of newly laid concrete	The work is continuous	Mechanical insertion	Yes	R Transverse 1%	N Depending on the needed correction. Financial penalties are included	R 65 (with Pendel)

Initial protection / Protection initiale / Schutzmaßnahmen / Protección inicial		Curing / Cure / Nachbehandlung / Curado		To check / Pour contrôle de / Zur Überprüfung / Para control de		Penalty / Pénaalités / Abzüge / Penalizaciones	
Type normally used	Protected length or number of hours	Type normally used	Minimum number of days when curing compound is not used	Strength	Thickness	For deficient strength	For deficient thickness
Méthode habituellement employée	Longueur protégée ou nombre d'heures	Méthode habituellement employée	Nombre de jours minimum si un produit de cure n'est pas employé	Résistance	Épaisseur	Pour insuffisance de résistance	Pour insuffisance d'épaisseur
Gebrauchliche Maßnahmen	Geschützte Länge oder zeitliche Dauer	Gebrauchliche Arten	Mindestdauer, wenn kein Nachbehandlungsmittel verwendet wird	Festigkeit	Dicke	Für Minderfestigkeit	Für Minderdicke
Método utilizado habitualmente	Longitud protegida o número de horas	Método utilizado habitualmente	Mínimo número de días cuando no se utiliza un producto de curado	Resistencia	Espesor	Por falta de resistencia	Por falta de espesor
73	74	75	76	77	78	79	80
1	Curing compound applicable on fresh concrete Special curing compound if rain threatens		Curing compound applicable on fresh concrete Special curing compound if rain threatens		When cubes and beams are not satisfactory	0,02 x price/m <sup>2</sup> x area x x strength deficiency	
2	Curing compound Plastic membrane when exposed aggregate finishing + curing compound after brushing		White pigmented resin based curing compound		Yes (compressive strength)	Yes	$RR = 0,2 pS \left( \frac{R_{\text{e}} - RM}{2 SR} \right)^2$ SR = standard deviation S = surface p = unit price RM = average strength RR = penalty Ro: required strength $EE = pS \left( \frac{E_0 - EE}{E_0 - 0,8 E_{\text{nom}}} \right)^2$ $E_0 = 0,95 E_{\text{nom}} + 2$ Standard deviation
3	M Curing compound	M Min. 7 days	M Curing compound		M Recommendation: - compressive strength - tensile strength - splitting strength - tensile strength of top layer	R M Every 3000 m <sup>2</sup>	Yes Yes
4	Polyethylene membranes	Until the retarded mortar has been brushed off	25% cut-back bitumen in gasoline		N	Minimum thickness prescribed	Rejection Rejection
5	Mobile cover	About 50 m	Curing compound or water spray	7	One core every 1000 m <sup>2</sup>		Yes Yes
6	N Except for chemical stripping: air flexible protective sheet between spreading and brushing	24-48 hours according to air temperature (500-2000 m)	Curing compound certified by COPLA Standardization on progress	R 3-7 days according to air temperature and humidity	When insufficient results of control tests Strength must be at least equal to that obtained on cores extracted from a reference stretch and tested at the same age		Removal of slab(s) or guarantee of service life Removal of slab(s) or guarantee of service life
7	Curing tents	About 30 m	Plastic emulsion		One core every 150 m	One core every 150 m	N N
8	R M, MR: concrete laying and finishing under tents Protective tents or canopies immediately after finishing	N About 60-100 m E Protection is sometimes omitted	Spraying with curing compound immediately after texturing	Spraying with water at least 3 days Waterproof membranes and moist mats are permitted as well	R One core each 1000 m <sup>2</sup> and construction lane	R One core each 1000 m <sup>2</sup> and construction lane	R Financial penalty or removal of slab(s) R Financial penalty or removal of slab(s)
9	R Aluminised resin-based sprayed curing compound	N	R Aluminised resin-based sprayed curing compound	N	E For strength R For density 3 cores per 1200 m	E	Removal of slab(s) Removal of slab
10	R Polyethylene sheet (PCP)	24 hours	Curing compound	7 days	R Not less than 90% of specified strength	R Not more than 5 mm under specified thickness	R Reduction of 80% of unit price if extra tests required by engineer fall under 90% of specified strength R Between 5 and 15 mm: price reduction coefficient = (average thickness / (required thickness - 5)) <sup>2</sup> Between 15 and 25 mm: 20% Over 25 mm: removal of slab(s)
11	N		A Curing compound	N	A If specified: 12 cores every 10000 m <sup>2</sup> (compressive strength; if h < 100 mm, splitting strength)	A If specified: 12 cores every 10,000 m <sup>2</sup>	A If specified: removal of slab(s) A If specified: removal of slab(s)
12	Curing membrane (+ tent)	R Min. 6 h against sun, rain and wind	Curing membrane		R 1 core per 2000 m <sup>2</sup> Min. 3 cores for areas < 2000 m <sup>2</sup> Min. 5 cores for areas > 2000 m <sup>2</sup>	R 1 core per 2000 m <sup>2</sup> Min. 3 cores	Financial penalty or removal of slab(s) Financial penalty or removal of slab(s)
13	E Tents	E 1 h	R M, MR Curing compound	7 days	R M, MR Yes	R Yes	N N
14	R In hot weather, spraying with water In rainy weather, protective tents or plastic sheet or rain-resistant curing compound	R 50 m	Curing compound (min 200 g/m <sup>2</sup> )	R 3	R Only when strength of cast beams is < 90% of specified value	R Min. 2 per day (5 if one of them has a thickness lower than nominal value)	R Financial penalty or removal of slab(s) R Financial penalty or removal of slab(s)
15			Water curing	3-5	3 cores every 3000 m <sup>2</sup> for compressive strength 3 cores every 3000 m <sup>2</sup> for splitting strength 2 cores every 3000 m <sup>2</sup> for frost resistance	Yes	
16	Tent when fixed form paver is used	About 100 m	Curing compound, 200 g/m <sup>2</sup>	7 days	N Compression at 28 days	Not. Control is done before or during the construction	N Removal of slab(s) or financial penalty

PAVEMENT DRAINAGE / DRAINAGE DU REVETEMENT / ENTWÄSSERUNG DER BEFESTIGUNG / DRENAJE DEL PAVIMENTO		SHOULDERS FOR MOTORWAYS AND MAIN ROADS / BANDES D'ARRÊT D'URGENCE POUR AUTOROUTES ET ROUTES PRINCIPALES / STRANDSTREIFEN AN AUTOBAHNEN UND HAUPTSTRASSEN / ARCENES DE ATPISTAS, Y CTRAS. PLES.		OFFICIAL SPECIFICATIONS / PRESCRIPTIONS OFFICIELLES / VORSCHRIFTEN / PRESCRIPCIONES OFICIALES	
Is a drainage system provided for the water infiltrated under the concrete slabs? Un système de drainage pour évacuer l'eau s'infiltrant sous le revêtement est-il employé? Wird ein Entwässerungssystem zur Ableitung des Wassers unter der Betondecke vorgesehen? ¿Se dispone algún sistema de drenaje del agua infiltrada bajo el pavimento de hormigón?	Method employed Méthode utilisée Angewandte Systeme Método utilizado	Concrete shoulders Thickness B.A.U. en béton Epaisseur Betonstendstreifen Dicke Arcenes de hormigón Espesor mm	Other types Autres types Andere Ausführungen Otros tipos	Authority issuing Administration compétente Herausgeber Organismo rector	Year of latest version and date of supplements Date de la dernière édition et date des suppléments Jahr der letzten Ausgabe und Daten der Nachträge Año de la última versión y fecha de los suplementos
81	82	83	84	85	86
1	Yes	Lateral drainage or drainage under transverse joints	Same thickness as carriageway	Austrian Highway Research Board RVS 8.06.32 «Deckenarbeiten-Betondecke -Deckenherstellung»	1990
2	A	Permeable shoulder foundation	A 200 CRCP 230 PC	A 50 mm bituminous surfacing 150 mm treated subbase or granular subbase or porous lean concrete	Ministry of Public Works 1988
3			240	Government standards and specifications set by investor	1988
4	Yes	A	A	A	The Danish Road Directory 1984
5	Yes	Well-drained gravel layer under the subbase	Same thickness as pavement	Asphalt shoulders (more used)	No official specifications for concrete pavements
6	R Lateral drainage P Permeable layer under concrete slabs	Permeable marginal strip: porous concrete or pervious granular material, according to traffic Permeable geotextile: sheets or strips	Equal to pavement thickness, but often using less resistant concrete	Related to traffic Hydraulic binder treated layers on unbound granular materials (often permeable)	1 Direction des Routes-CTG Fascicule 28-Execution des chaussées en béton de ciment 2 SETRA-LCPC-Catalogue des structures types de chaussées neuves 3 SETRA-LCPC-Directive pour la réalisation de chaussées en béton de ciment 4 Norme NF 98 170 Chaussées en béton de ciment-Execution, suivi et contrôles (in progress)
7	N		Like traffic lane		1989
8	R According to RAS-drainage, but no special system for concrete roads as a rule	E Several systems tested: longitudinal and transverse drains, fleeces, geotextile	R As the traffic lane	M, MR: other types normally not used MR, SR: unbound granular material	Bundesministerium für Verkehr (Federal Ministry of Transport) Design: RS10 1986, suppl. 1989 Pavement: ZTV Beton 1978, suppl. 1980, 1982 and 1990 Sub-base: ZTVV-SiB 1981 ZTVT-SiB 1986
9	Yes	A Crossfall to sub-base and longitudinal drain R Polythene sheet under layer	A Same as carriageway	X	Department of Transport, England; Scottish Development Department; Welsh Office; DOE Northern Ireland 6th Edition 1986 Supplement 1988 (Appendix L) (7th Edition due end of 1990)
10	R Yes	R For CPC: porous concrete For JPCP: longitudinal drainage	For PCP: porous concrete, 220	N	Consiglio Nazionale delle Ricerche (CNR) Azienda Nazionale Strade (ANAS) Società Autostrade SpA CNR: 1972 ANAS: 1976 Autostrade: 1989
11	N		Same thickness as concrete pavement	N	1) «Richtlijnen voor het ontwerpen van autosnelwegen (ROA)», 1975 (Guidelines for the design of motorways) 2) «Richtlijnen voor het ontwerpen van niet-autosnelwegen (RONA)», 1984 (Guidelines for the design of non-motorways) 3) «RAW Standard 1990», 1990 NEN Standards 1) 1975 2) 1984 3) 1990
12	R Yes	R Draining on both sides Draining material are required in subbase	Same as pavement	Asphalt concrete on penetrated base	Norwegian Public Roads Administration 1980 Official specifications under revision. Considerable changes will be proposed
13	R Yes	R M, MR Crossfall > 2% Porous concrete associated with drainage layer material or slotted pipes	A 150-250 depending on slab thickness	A Bituminous layer on granular or cement treated layers	Junta Autónoma de Estradas (J.A.E.) 1985 1988, supplements
14	N Usually in case of undowelled joints	E Usually marginal permeable strip (lean concrete or unbound granular) (frequently combined with longitudinal slotted pipes)	R Same thickness as concrete slab in a 40 cm wide marginal strip. Rest of shoulder: 150 mm	R Bituminous surfacing plus cement-treated base or soil-cement or permeable unbound roadbase material	Ministerio de Obras Públicas y Urbanismo «Pliego de Prescripciones Técnicas Generales para Obras de Carreteras y Puentes PG-4» (Chapter 550), 1990 «Instrucción 6.1. y 6.2.-IC sobre secciones de firme» 1989
15	No		Not used	Asphalt shoulders	Road Administration 1990
16	No		Not used	Bituminous surfacing	VSS-specifications For concrete, SIA specifications Specifications have been revised during the last years on various parts. Last revision referred to concrete: 1989



**Innovation Through Partnerships**

PRINTED BY—  
Federal Highway Administration  
U.S. Department of Transportation  
400 Seventh Street, SW.  
Washington, D.C. 20590

Publication No. FHWA-SA-93-012

HT A-20/12-92(6M)E