



TRAFFIC SIGN DESIGN, PLACEMENT, AND APPLICATION GUIDELINES

**PREPARED BY
Traffic and Safety
Transportation Systems Management Operations (TSMO) Division**

Revised 11/28/23

"Serving and connecting people, communities, and the economy through transportation."

TABLE OF CONTENTS

TABLE OF CONTENTS.....	i
INTRODUCTION.....	1
DEPARTMENT FUNCTIONS AND RESPONSIBILITIES.....	1
<i>PERMANENT SIGNING PROJECTS.....</i>	<i>1</i>
<i>EXPERIMENTAL TRAFFIC CONTROL DEVICES.....</i>	<i>3</i>
<i>QA/QC PROCESS TEMPLATE.....</i>	<i>4</i>
<i>TRAFFIC SIGNING QA/QC PROCEDURE.....</i>	<i>4</i>
NEED FOR SIGNING GUIDELINES.....	4
1. SIGNING BASICS.....	5
SIGNING PRIORITIES.....	5
SIGNING PRINCIPLES.....	6
SIGN SPACING.....	7
SIGN SUPPORTS.....	7
2. SIGN DESIGN.....	10
<i>STANDARDIZATION.....</i>	<i>10</i>
<i>SIGN COMBINATIONS.....</i>	<i>10</i>
REGULATORY SIGNS.....	11
<i>SIZE OF REGULATORY SIGNS.....</i>	<i>11</i>
<i>ALL WAY STOP AND CROSS TRAFFIC DOES NOT STOP CONDITIONS.....</i>	<i>12</i>
<i>REFLECTIVE STRIPS ON SIGN POSTS.....</i>	<i>13</i>
<i>SPEED LIMIT SIGNS.....</i>	<i>13</i>
<i>LANE-USE CONTROL SIGNS.....</i>	<i>13</i>
<i>NO TURN ON RED SIGNS.....</i>	<i>14</i>
<i>TWO-WAY, LEFT-TURN ONLY SIGNS.....</i>	<i>15</i>
<i>NO PASSING CONTROL SIGNS.....</i>	<i>15</i>
<i>PASSING LANE TRAFFIC CONTROL SIGNS.....</i>	<i>16</i>
<i>NO PASSING CONTROL AT RAILROAD CROSSING.....</i>	<i>16</i>
<i>RAILROAD CROSSBUCK SIGNS.....</i>	<i>16</i>
<i>WINTER PARKING RESTRICTIONS SIGNS.....</i>	<i>17</i>
<i>NO CAMPING OR OVERNIGHT PARKING SIGNS.....</i>	<i>17</i>
<i>LOCAL PARKING ORDINANCE SIGNS.....</i>	<i>17</i>
WARNING SIGNS.....	18
<i>ADVANCED CROSSROAD / SIDE ROAD SIGNS.....</i>	<i>20</i>
<i>RAILROAD ADVANCE SIGNS.....</i>	<i>20</i>
<i>ADVANCE WARNING SIGNS AND ADVANCE HORIZONTAL ALIGNMENT SIGNS.....</i>	<i>20</i>
<i>CHEVRON ALIGNMENT SIGNS.....</i>	<i>25</i>
<i>REFLECTIVE STRIPS ON SIGN POSTS.....</i>	<i>26</i>
<i>ADVANCED SNOWMOBILE AND ALL TERRAIN VEHICLE (ATV) CROSSING SIGNS.....</i>	<i>26</i>
GUIDE SIGNS.....	27
<i>ADVANCE GUIDE/EXIT DIRECTION SIGNS.....</i>	<i>27</i>
<i>SUPPLEMENTAL GUIDE SIGNS.....</i>	<i>27</i>

NON-FREEWAY GUIDE SIGNS	28
CONTROL CITIES FOR DIRECTIONAL SIGNING.....	29
STREET NAME AND ADVANCE STREET NAME SIGNS	30
TRAVEL INFORMATION RADIO STATION SIGNS	31
RECREATIONAL SIGNS.....	31
HISTORICAL MARKER SIGNS.....	32
MISCELLANEOUS INFORMATION SIGNS.....	32
CARPOOL LOT SIGNS	32
REST AREA / WELCOME CENTER SIGNS.....	33
ROADSIDE PARKS AND SCENIC TURNOUTS.....	35
SNOWMOBILE USE ON COUNTY ROADS SIGNS	35
SLOGAN SIGNS	36
MEMORIAL / DEDICATED HIGHWAY SIGNS	36
EMERGENCY SERVICES SIGNS	36
MDOT SUPPLIED SIGNS.....	37
OBJECT MARKERS.....	37
3. SIGN PLACEMENT	39
<i>FREEWAY RAMPS.....</i>	39
<i>CONVENTIONAL ROAD ADVANCE SIGNING TO INTERCHANGES.....</i>	42
<i>FREEWAY ADVANCE SIGNING TO INTERCHANGES.....</i>	43
<i>OVERHEAD ARROW-PER-LANE AND DIAGRAMMATIC GUIDE SIGNS</i>	45
<i>AFTER INTERCHANGES / ROUTE CHANGES / MAJOR HIGHWAY JUNCTIONS</i>	45
<i>JUNCTION ASSEMBLY SIGNS</i>	46
<i>SPEED LIMIT SIGNS.....</i>	47
<i>RESERVED PARKING FOR PERSONS WITH DISABILITIES.....</i>	47
<i>STOP AHEAD AND SIGNAL AHEAD SIGNS</i>	47
<i>DIRECTIONAL CROSSOVERS AND DIVIDED HIGHWAYS</i>	48
<i>RAILROAD EXEMPT SIGNING.....</i>	48
<i>NO ENGINE BRAKE SIGNS</i>	48
<i>WEIGH STATION</i>	49
<i>ROUNDBOUT.....</i>	49
<i>MISCELLANEOUS SIGN PLACEMENT.....</i>	49
<i>INCIDENT MANAGEMENT ROUTE SIGNING</i>	52
4. TRAFFIC CONTROL ORDERS AND DETERMINATIONS.....	54
<i>CHANGEABLE "YOUR SPEED" SIGNS</i>	54
5. SCHOOL, PEDESTRIAN, AND NON-MOTORIZED SIGNING	56
SCHOOL SIGNS.....	56
<i>ADVANCE SIGNING.....</i>	56
<i>CROSSING SIGNING.....</i>	57
<i>SIGN COLOR AND PLACEMENT.....</i>	57
<i>REFLECTIVE STRIPS ON SIGN POSTS</i>	57
<i>SCHOOL CROSSING ESTABLISHMENT.....</i>	57
<i>SCHOOL BUS STOP WARNING SIGNS.....</i>	57
PEDESTRIAN SIGNS	57
<i>ADVANCE SIGNING.....</i>	57
<i>CROSSING SIGNING.....</i>	57
<i>SIGN COLOR.....</i>	58
<i>REFLECTIVE STRIPS ON SIGN POSTS</i>	58
TRAIL CROSSING SIGNS.....	58

<i>ADVANCE SIGNING</i>	58
<i>CROSSING SIGNING</i>	58
<i>SIGN COLOR</i>	59
<i>REFLECTIVE STRIPS ON SIGN POSTS</i>	59
BICYCLE SIGNS	59
<i>ADVANCE SIGNING</i>	59
<i>CROSSING SIGNING</i>	59
<i>ON THE ROAD SIGNING</i>	59
<i>PLACEMENT INFORMATION</i>	60
<i>PROHIBITIONS</i>	60
<i>SIGN COLOR</i>	60
<i>REFLECTIVE STRIPS ON SIGN POSTS</i>	60
6. LOGOS, TODS, & ADOPT-A-HIGHWAY	61
SPECIFIC SERVICE (LOGO) SIGNING	61
TOURIST ORIENTED DIRECTIONAL SIGNS (TODS).....	61
ADOPT-A-HIGHWAY SIGN REPLACEMENT	62
7. OVERHEAD SIGN STRUCTURES.....	63
<i>USE</i>	63
<i>STRUCTURE CRITERIA</i>	64
<i>PRIORITY</i>	65
<i>DESIGN</i>	65
 APPENDIX A – Figures and Tables	
Interchange Crossroad Guide Signing for One Direction	
One-Lane-Approach	
Multi-Lane-Approach	
Partial Cloverleaf Interchange	
Cloverleaf Interchange Crossroad	
Retroreflective Sign Sheeting Material Guidelines	
Sign Panel and Sign Face Guide	
Freeway Clearview Letter Sizes	
Non-Freeway Clearview Letter Sizes	
Process for Invoicing and Reimbursement	
Bridge Sign Connection Cheat Sheet	
DDI	
Entrance Ramp	
Exit Ramp	
Crossing Area	
Arrival and Departure	
SPUI	
Entrance	
Crossing Area/Arrival and Departure	
Exit	
 APPENDIX B – Sign Layouts	
Guidelines for Sign Combinations	

- Lane-Use Control Signs
- No Passing Control at Railroad Crossings
- Roadway Delineation
- Advisory Speed Signs for Ramps with Limited Visibility
- Determination of Advisory Speed on Curves
- Signing for Directional Crossovers
 - Single Left Directional Crossover
 - Dual Left Directional Crossover
 - Single Left Directional Crossover Located Opposite a Street
 - Dual Left Directional Crossover Located Opposite a Street
- Signing for Bidirectional Crossover
- Signs at Divided Highway Intersections
- Carpool Lot
- Traffic Control Plan for Passing Lanes
- Example Signing for Freeway Weigh Stations
 - With Bypass Lane
 - Without Bypass Lane
- Example Signing for Non-Freeway Weigh Stations
- Example Approach Signing
 - Junction of Two Non-Freeway Trunklines
 - Intersection of Non-Freeway Trunkline and Other Roadway
- Minimum Advance Placement
 - Distance for Signing Required in Condition A Scenario
 - Distance for Curve Signing Required in Condition B
- Typical Rest Area/Welcome Center Signing

APPENDIX C – Arrow-per-Lane Guidelines

- Case 1 Multi-Lane Exits with an Option Lane
- Case 2 Multi-Lane Exits with an Option Lane
- Case 3 Multi-Lane Exits with an Option Lane
- Case 4 Multi-Lane Exits with an Option Lane
- Truss Elevation Type E

APPENDIX D – Roundabout Signing Guidelines

- Roundabout Signing Guidelines
- Example Signing
 - Roundabout Approach
 - Roundabout Interior
 - Roundabout Departure
 - Roundabout at a Freeway Interchange
 - Roundabout with Right-Turn Bypass Lane

APPENDIX E – Incident Management Route Signing

- Incident Management Route Signing

INTRODUCTION

All freeway and non-freeway sign design, placement, and application shall adhere to the latest editions of the following:

- Michigan Vehicle Code (MVC) and other applicable Michigan State Statutes as part of Michigan Compiled Law (MCL)
- *Michigan Manual on Uniform Traffic Control Devices* (MMUTCD)
- Guidelines for Signing on State Trunkline Highways
- Guidelines for Traffic Control in School Areas
- Michigan Standard Highway Signs (SHS)
- Sign Support Standard Plans and Special Details
- Traffic and Safety Notes
- Standard Specifications for Construction
- Road and Bridge Standard Plans and Special Details

In addition to the above documents, these guidelines are intended to provide additional guidance to designers on the appropriate design, placement, and application of freeway and non-freeway signing.

DEPARTMENT FUNCTIONS AND RESPONSIBILITIES

The Michigan Department of Transportation (hereinafter referred to as Department) has the primary responsibility to develop, maintain, and operate a statewide trunkline highway system designed to move traffic from one destination to another in a safe, efficient, and expeditious manner. Erecting and maintaining highway traffic signs on the state highway system are a part of this responsibility and a requirement in Section MCL 257.609.

Standards for the design and application of all highway traffic signs erected on public highways are specified in the *Michigan Manual on Uniform Traffic Control Devices* (MMUTCD) which, in turn, is required by Section MCL 257.608 to conform to national standards on highway signing.

PERMANENT SIGNING PROJECTS

The design and placement of permanent signing as part of a department designed construction project is accomplished by one of the four methods discussed below. For consultant designed projects, all signing will be designed by the consultant and included in the construction project. At the time of the scoping meeting, the Region Traffic and Safety Representative will determine which method is to be employed. The four methods and important points to keep in mind for each method are outlined below.

- I. Signing Included with the Construction Contract
 - a. The Region/TSC Staff or Consultant will prepare signing plans and quantities.
 - b. The plans, quantities, and estimate will be incorporated in the proposal package by the project manager.

- II. Signing by Separate Signing Contract
 - a. The Traffic Signing Unit Manager will determine the appropriate funding source for the work.
 - b. The Traffic Signing Unit will prepare plans, quantities, and a cost estimate for freeway and non-freeway signing projects.
 - c. The Traffic Signing Unit will prepare contract documents for both freeway or non-freeway signing projects and forward appropriate material to Design for contract letting.

- III. Signing by Transportation Work Authorization (Force Account) to State Forces or Contract Agencies – Costs Charged to Routine Maintenance
 - a. This method should be limited to small projects with minimal signing and only if one of the other three methods cannot be used, since maintenance funds are limited.
 - b. The Region/TSC Traffic & Safety Representative will prepare and issue a Region/TSC traffic work authorization.

There are many instances during roadway construction (Method I) wherein county roads and city streets are modified from the initial state. Some roads are terminated, others are rebuilt as grade separations with the accompanying built-in sight restrictions, others are terminated at services drives, and still others are reconstructed in the initial form but with the freeway either over or under. In the latter case, the initial traffic signs and pavement markings are obliterated during construction.

In order to maintain statewide uniformity and also to restore, as part of the project, the local system or in some cases complete the local system to operational use, the following procedure is followed:

1. Signing and pavement marking for newly constructed service drives will be done either by Region work authorization or as part of the freeway project.
2. On newly constructed grade separations with built-in sight restrictions, the necessary signs and markings for no passing zones will be authorized by either Region work authorization or as part of the freeway project.
3. Signs will be provided for roads permanently terminated at the freeway right-of-way limit.
4. Crossroads which are reconstructed to the original state will have traffic signs and pavement markings, in accordance to the Michigan Manual on Uniform Traffic Control Devices, restored.

NOTE: The department should maintain the traffic signs and pavement markings identified above until jurisdiction is returned or transferred to a local road agency.

Normally, the department is responsible only for the erection and maintenance of traffic signs placed along state trunkline highways. It is frequently desirable, however, to provide certain guide signs along county roads or city streets on their approaches to freeway interchanges. To define limits of responsibility more clearly for the erection and maintenance of such signs, the following information is provided.

On freeways, the department is responsible for the erection and maintenance of all signing along the freeway and along freeway ramps. On non-trunkline crossroads in the immediate vicinity of freeway interchanges, the department is responsible for the erection and maintenance of signs which provide route and destination information pertaining directly to the freeway. Such signs, although technically located off the state trunkline highway system, are still the responsibility of the department. The extent of such signing shall be limited to standard junction approach signing. The full junction sequence may be applied to unnumbered crossroads where traffic operating conditions approximate those encountered on trunkline highways. Where these signs have been authorized and placed by contract or departmental work order, they must be maintained in good operative condition, the same as signs located directly along freeways.

An attorney general opinion points out that maintenance of sign installations along a non-trunkline road or street which are needed to provide direction to motorists seeking access to a freeway would in no way obligate the department to provide additional traffic signal or roadway maintenance along the local route. All other signs on these non-trunkline crossroads are the responsibility of the local jurisdiction.

On streets and roads cut off by limited access highways, the DEAD END (W14-1) and NO OUTLET (W14-2) signs should be erected as specified in the Michigan Manual on Uniform Traffic Control Devices. A copy of the traffic work authorization should be sent to the local roadway agency along with an explanation that they are responsible for maintenance of the signs.

EXPERIMENTAL TRAFFIC CONTROL DEVICES

Continuing advances in technology will produce changes in the highway, the vehicle, and in the proficiency of the motorist. To address these advances and ensure new traffic control devices will meet the needs of the department and the motorist, an experimentation process is in place. This process, as outlined in Part 1 of the MMUTCD, requires the department to request permission from the Federal Highway Administration (FHWA) to experiment. This request must include a planned evaluation of the device to provide a meaningful evaluation. Further details of the request can be found in the MMUTCD.

All proposals for new traffic control devices or new applications for standard devices are welcome. To ensure statewide uniformity, all requests need to be coordinated with Lansing Traffic and Safety before submittal to FHWA.

QA/QC PROCESS TEMPLATE

The Traffic and Safety Project manager is responsible to determine the QA/QC process when developing a project. A reference to the QA/QC review process table can assist the Project Manager in this determination to ensure that a project follows the general outline of plan development per Road Design Manual.

TRAFFIC SIGNING QA/QC PROCEDURE

It is the responsibility of Traffic and Safety to perform QA/QC reviews of the entire signing contract. The Project Manager and/or Technical Assistant must perform a system of checks/reviews to verify all requirements of the plan/proposal package prior to submittal to the Specifications and Estimates Unit. Specific procedures and requirements to perform QA/QC are described in Chapter 14 of the Road Design Manual, the Program/Project Management System and in the Quality Assurance/Quality Control Process Guide for Project Managers.

NEED FOR SIGNING GUIDELINES

Enactment of the Highway Advertising Act of 1972 (Act 106 of the Public Acts of 1972) and its subsequent amendments have placed severe restrictions on billboard advertising, thus increasing demand on the Department to place additional directional information signs within highway right-of-way. In order to respond to all sign requests in a fair and consistent manner, the State Transportation Commission recognizes the need to establish signing guidelines that will address all aspects of highway signing while maintaining a safe and logical sequence of informational displays along state trunkline highways. Further information on Act 106 of the Public Act of 1972 and its impacts can be found in the Department's Highway Advertising Manual.

Although the aforementioned MMUTCD contains standards for design and application of traffic control devices, it does not contain specific criteria on the following subjects for all signs: (1) allowable sign messages, (2) qualifications which allow placement of highway signs for various facilities and/or activities, or (3) priority (ranking) of the various sign groups on the basis of highway user needs which, in turn, should determine the selection process for sign installation.

The Guidelines for Signing on State Trunkline Highways address these subjects and provide criteria by which to evaluate all highway signing requests consistently and equitably and to ensure information with little value to general highway users is not displayed.

1. SIGNING BASICS

SIGNING PRIORITIES

Basic concepts of traffic engineering recognize the primary functions of traffic control signs are to warn, regulate, and guide traffic. Sign spacing and the amount of information displayed have an impact on the driver's ability to read and respond to sign messages in an expected, predictable manner.

Accordingly, the primary function of traffic control signs is to enable drivers to react promptly, naturally, and safely to the traffic and design conditions encountered, to inform on regulations and use of streets and highways, to warn of unexpected highway conditions which require extra care driving, and to provide guidance to major destinations.

Secondary functions of traffic control signs are to advise drivers of various services normally required to complete an extended journey (emergency services, motorist services, public transportation), and of supplemental services, such as recreational facilities, places of interest, and attractions.

Traffic control signs can be classified into eight basic sign groups. Following is the order of priorities adopted by the national committees of the American Association of State Highway and Transportation Officials and Institute of Transportation Engineers for these sign groups, and a brief description of the function of each sign group:

<u>Group No.</u>	<u>Sign Type</u>
1.	REGULATORY SIGNS - Inform the driver of traffic or regulations concerning vehicle operation on the highway (i.e., stop, yield, speed limit signs, etc.).
2.	WARNING SIGNS - Advise the driver of unexpected highway conditions which require extra care driving (i.e., curve, Stop Ahead, Chevron signs, etc.).
3.	NAVIGATIONAL GUIDE SIGNS - Identify the route or routes the driver may follow to complete a trip, including directions and distances to cities and other destinations (standard guide signs, i.e., route markers, distance and destination, exit direction, etc.). Advise the driver of destinations accessible other than those shown on standard guide signing (i.e., township supplemental freeway signing).
4.	EMERGENCY SERVICES SIGNS - Advise and direct the driver to facilities providing emergency services or assistance. Such facilities include hospitals providing emergency medical treatment and state, county, or local enforcement agencies.
5.	MOTORIST SERVICES SIGNS - Advise and direct the driver to basic

services normally needed to complete a long trip (i.e., gas, food, lodging, and camping, tourist information centers, welcome centers, and rest areas).

6. PUBLIC TRANSPORTATION SIGNS - Advise and direct the driver to facilities that provide commercial and public passenger travel service (i.e., airports, train stations, bus stations, vehicle ferry docks).
7. TRAFFIC GENERATOR SIGNS - Advise and direct the driver to activities, facilities, or special points of interest which attract a significant number of people who are unfamiliar with the local area and/or access routes.
8. GENERAL INFORMATION SIGNS - Advise the driver of information which may be of interest and in most instances a geographic reference, although not directly necessary for travel (i.e., political boundary limits, landmarks, Historic Site, Adopt-A-Highway, Heritage Routes, Memorial Signing, Tourist Oriented Directional Signs (TODS), Community Wayfinding Signing, etc.).

Within a certain distance in advance of an interchange or intersection, signing needs will be evaluated and signs installed in descending priority, providing a minimum standard spacing between signs is maintained, thus avoiding informational overload and potential driver confusion.

It may be necessary to rank signs within a single priority group. An example of this situation would be where there are more qualifying traffic generators than can be accommodated under the established guidelines. In this circumstance, the qualifying generators will be ranked according to attendance and those exceeding the warrants the most will be given priority.

SIGNING PRINCIPLES

The design (shape, size, and color) of traffic signs used in Michigan conforms, as nearly as possible, to national sign standards. Uniform use and standardization of traffic signs is desirable to ensure instant recognition and uniform interpretation by all drivers.

A traffic sign should be installed only if it fulfills a specific need. In order to be effective, a sign should have attention value, a clear simple message, be well maintained, and be located so drivers have adequate time to see, comprehend, and respond appropriately.

Information overload may result from too many signs, nonessential signs, insufficient spacing between signs, excessive lines of legend, inadequate conspicuity or legibility, or a combination of these factors.

Regulatory and warning signs should be installed only where mandated or warranted so their effectiveness will not be diminished by excessive use.

Guide signs should be installed when they are essential to the motorist or beneficial to a significant number of drivers.

In general, guide signs along a highway are necessary for motorists who are unfamiliar with the route and need guidance to reach their destinations. The most important guide signs are those which provide guidance to major metropolitan areas and/or highway routes or places of national prominence.

Signs serving other destinations (excluding cities, villages, routes, etc.) are classified as supplemental guide signs. Sign priority groups 4 through 8 are considered supplemental guide signs. Supplemental guide signs are secondary to principal signing needs (groups 1 through 3) and should be used sparingly.

SIGN SPACING

Sign installation will depend on whether there is sufficient longitudinal space to accommodate new sign installation without violating the minimum allowable spacing between signs. Minimum spacing between standard guide signs should not be less than 800 feet on rural freeways and 600 feet on urban freeways. For non-freeways, the minimum spacing is 350 feet in rural areas and 200 feet in urban areas. This minimum spacing between principal guide signs will not be violated for the purpose of signing to traffic generator facilities.

On the state trunkline system, there are limits for the placement of signs pertaining to freeway interchanges and non-freeway intersections. For freeways, the limit for signs in advance of an interchange is the allowable advance guide signing distance for that interchange or two miles maximum. For interchanges spaced closer than two miles, the first sign may be placed closer than the two miles maximum but should not overlap signing for the previous interchange. This is what is known as allowable advance guide signing distance.

For non-freeways, the limit for signs in advance to an intersection is 2,500 feet or not beyond a previous intersection, whichever distance is less.

SIGN SUPPORTS

All signs within Department right-of-way shall be mounted on supports in accordance to the Department's Sign Support Standards. These supports are designed to maintain rigidity against wind forces and other non-impact loads but, for roadside installations, will yield when struck by a vehicle. For overhead cantilever and truss signs, supports within the clear zone must be protected by guardrail, barrier, or an energy absorbing system. The crashworthy characteristics of sign supports decreases the potential for injury or fatal crashes if a vehicle were to strike the appropriate sign support or its protecting device.¹

Reflective strips shall be added to the posts of the following signs:

- Regulatory - AUTHORIZED VEHICLES ONLY, and DO NOT ENTER and WRONG WAY signs on ramps shall have reflective strips installed on the posts. Reflective strips are also installed if the intersection meets the warrants of "All

¹ [SIGN – 150 Sign Support Selection Charts](#)

Way Stop and Cross Traffic Does Not Stop Conditions”.²

- Warning – W1 series signs, and midblock Pedestrian, Bike, Trail, and School Crossings shall have reflective strips installed on the posts. Stop Ahead symbols and Yield Ahead symbols shall have reflective strips if reflective strips are used on the STOP and YIELD signs.

The sheeting of the reflective panel must match the background color of the sheeting of the sign mounted on the post, except for YIELD and DO NOT ENTER signs where the reflective strip shall be red.

Wood and steel are the two materials used for roadside sign supports. Wood posts come in two sizes; 4-inch x 6-inch and 6-inch x 8-inch and must be drilled perpendicular to the traffic flow, as illustrated in the typical plans, to allow the post to break away when struck.³

Steel posts are either U-channel (commonly known as 3 lbs/ft posts) or square tubular post. U-channel posts are the commonly used support for small roadside signs due to its ease of installation.⁴ Square tubular steel post breakaway systems are primarily intended for use in urban areas, channelization islands, enhanced mile markers, exit gore signs, and other specified locations requiring multiple sign panel installations.⁵

Steel column breakaway posts are used for larger roadside sign installations. The breakaway feature is accomplished by adding a slotted plate to the top of the foundation post, another slotted plate to the bottom of the sign post, and by cutting the post just below the sign panel and adding a hinge system. The bottom plates are then bolted together at a specified torque. When struck, the post slips off the foundation at the bottom, and rotates around the hinge plate below the sign panel. This allows the vehicle to safely pass under the sign after impact.⁶

For installation of signs over the roadway, span wire, bridge mounts, cantilevers, and trusses are used. Selection of the appropriate overhead support will depend on the available room, roadside or bridge structure, utility conflicts, and the message being displayed.⁷

When choosing which type of material to use for a ground mounted sign installation, there are three resources available. Standard Sign Installations⁸ specifies support type for commonly used signs, the Standard Route Marker Installations special detail⁹ specifies the support for route marker clusters, and the Sign Support Selection Chart¹⁰ gives a general support type for signs with differing dimensions.

² [SIGN – 145 All Way Stop and Cross Traffic Does Not Stop Conditions](#)

³ [SIGN – 210 Wood Posts](#)

⁴ [SIGN – 200 Steel Posts](#)

⁵ [SIGN – 207 Perforated Steel Square Tube Sign Breakaway System](#)

⁶ [SIGN – 220 Steel Column Break-Away \(W\)](#)

⁷ [SIGN – 160 Cantilever Sign Support Selection](#)

⁸ [SIGN – 100 Standard Sign Installations](#)

⁹ [SIGN – 110 Standard Route Marker Installations](#)

¹⁰ [SIGN – 150 Sign Support Selection Charts](#)

Special attention should also be given to the suitability of utility poles or light standards to serve as sign supports. Utility poles and light standards in most urban areas are not the property of the Department. Permission to install signs on these supports should be requested of the utility company and/or community prior to sign installation.

2. SIGN DESIGN

STANDARDIZATION

The basic requirements of a highway sign are that it be legible to those for whom it is intended and that it be understandable in time to permit a proper response. Desirable attributes include:

- High visibility by day and night; and
- High legibility (adequately sized letters or symbols, and a short legend for quick comprehension by an approaching road user).

Standardized colors and shapes are specified so several classes of traffic signs can be promptly recognized. Simplicity and uniformity in design, position, and application are important. Design Uniformity shall include shape, color, dimensions, legends, borders, and illumination or retroreflectivity. Requirements for retroreflective sign sheeting materials, sign panels, and guide sign legends can be found in Appendix A.[11](#), [12](#), [13](#), [14](#)

SIGN COMBINATIONS

While it is preferable to erect traffic signs individually (except where one sign supplements another or where guide signs must be grouped), it is sometimes advantageous to group traffic signs to reduce the number of installations. A sign that is mounted back-to-back with a STOP or YIELD sign shall stay within the edges of the STOP or YIELD sign. If necessary, the size of the STOP or YIELD sign should be increased so that any other sign installed back-to-back with a STOP or YIELD sign remains within the edges of the STOP or YIELD sign. Appendix B provides guidance on what traffic signs can or cannot be combined with other traffic signs.[15](#)

[11](#) Appendix A-6: [Sign Type and Corresponding Material Type](#)

[12](#) Appendix A-7: [Sign Panel, Face Type and Corresponding Reflectivity](#)

[13](#) Appendix A-8: [Freeway Clearview Letter Sizes](#)

[14](#) Appendix A-9: [Non-Freeway Clearview Letter Sizes](#)

[15](#) Appendix B-2: [Combining Traffic Signs](#)

REGULATORY SIGNS

Table 1. Standard Regulatory Sign Sizes

Sign	Sign Code	Non-Freeway		Expressway	Freeway
		Single Lane	Multi Lane		
Stop	R1-1	30 x 30	36 x 36	36 x 36	-
Yield	R1-2	36 x 36 x 36		48 x 48 x 48	60 x 60 x 60
All Way	R1-3P	30 x 12	36 x 15	-	-
Speed Limit	R2-1	24 x 30	30 x 36	36 x 48	48 x 60
Combined Speed Limit (2 speeds)	R2-4a	-		-	48 x 96
Combined Speed Limit (3 speeds)	R2-4b	-		-	144 x 60
Turn Prohibition	R3-1, 2, 3, 4, 18	30 x 30	36 x 36	36 x 36	-
Lane Must Turn	R3-7L, R3-7R	30 x 30	36 x 36	-	-
Advanced Intersection Lane Control	R3-8	30 x 30		30 x 30	-
	R3-8a, 8b, 8m, 8n,	48 x 30		48 x 30	-
	R3-8e, 8f, 8g	36 x 24		36 x 24	-
Two-Way Left Turn Only (overhead)	R3-9a	36 x 48		-	-
Two-Way Left Turn Only (post-mounted)	R3-9b	24 x 42		-	-
Do Not Pass	R4-1	24 x 30		-	-
Pass With Care	R4-2	24 x 30		-	-
Slower Traffic Keep Right	R4-3	24 x 30		36 x 48	48 x 60
Keep Right	R4-7, 7a, 7b	24 x 30		36 x 48	-
Keep Right Except to Pass	R4-16	24 x 30		36 x 48	48 x 60
Do Not Enter	R5-1	36 x 36		36 x 36	48 x 48
Wrong Way	R5-1a	36 x 24		36 x 24	42 x 30
		Independent use 42 x 30		Independent use 42 x 30	
One Way	R6-1R, 1L	36 x 12	54 x 18	54 x 18	54 x 18
No Parking	R8-3a	18 x 24		24 x 30	-

- Notes: 1. Larger signs may be used when appropriate
2. Dimensions in inches are shown as width x height.

SIZE OF REGULATORY SIGNS

Sign size dimensions prescribed in the sign size tables shall be used unless engineering judgment determines that other sizes are appropriate. The number of lanes for which traffic will face will determine if a non-freeway single lane or multi-lane sign size will be used. The exception is stop signs. A road is considered a multi-lane if it has more than one lane moving in the same direction. A multi-lane approach has two or more lanes moving towards the intersection, including turning lanes. A three-lane road with one lane in each direction and a center two-way left turn lane is considered a multi-lane roadway. If the side road has a single lane approach to the trunkline, then non-

freeway single lane sign sizes shall be used for all signs (see stop signs for possible exceptions) approaching the trunkline. If the side road approach is multi-lane to the trunkline, the multi-lane sign size will be used for all signs approaching the trunkline from the multi-lane side road.

Where the posted speed limit is 35 mph or less on a multi-lane roadway, other than for a STOP sign, the minimum size shown for the Single Lane column in Table 1 may be used. Where a regulatory sign, other than a STOP sign, is placed on the left-hand side of a multi-lane roadway in addition to the installation of the same regulatory sign on the right-hand side of the roadway, the size shown in the Single Lane column in Table 1 may be used for both the sign on the right-hand side and the sign on the left-hand side of the roadway.

Where side roads intersect a multi-lane street or highway with a speed limit of 45 mph or higher, the minimum size of the STOP signs facing the side road approaches, even if the side road only has one approach lane, shall be 36 x 36 inches.

Where side roads intersect a multi-lane street or highway with a speed limit of 40 MPH or lower, the minimum size of the STOP signs facing the side road approaches shall be as shown in the Single Lane or Multi-lane columns of Table 1 based on the number of approach lanes on the side street approach.

ALL WAY STOP AND CROSS TRAFFIC DOES NOT STOP CONDITIONS

The Stop Sign (R1-1), All Way Plaque (R1-3P), and Stop Ahead Sign (W3-1) shall be installed per SIGN-145¹⁶ for rural non-freeways of 55 MPH or greater with all way stop conditions.

The Stop Sign (R1-1), Cross Traffic Does Not Stop Plaque (W4-4P), and Stop Ahead Sign (W3-1) shall be installed per SIGN-145-A for rural non-freeways of 55 MPH or greater with two way stop conditions when one or more of the following criteria have been met:

1. The crossroad (under stop control):
 - a. National Functional Classification of Major Collector or greater, or
 - b. has a cross section of 3 lanes or more, or
 - c. has all way stop control intersection(s) in advance of the state Trunkline
 - d. intersection
2. Intersection:
 - a. Overhead flashing beacon(s) in place, or
 - b. both roadways have similar ADTs, or
 - c. a pattern of correctable crashes, or
 - d. when available sight distance indicates potential confusion for drivers

¹⁶ [SIGN – 145 All Way Stop and Cross Traffic Does Not Stop Conditions](#)

REFLECTIVE STRIPS ON SIGN POSTS

All AUTHORIZED VEHICLES ONLY, and DO NOT ENTER and WRONG WAY signs on ramps shall have reflective strips installed on the posts. The sheeting of the reflective panel must match the background color of the sheeting of the sign mounted on the post, except for YIELD, if used, and DO NOT ENTER signs where the reflective strip will be red. Reflective strips are also installed if the intersection meets the warrants of “All Way Stop and Cross Traffic Does Not Stop Conditions”.¹⁷

SPEED LIMIT SIGNS



R2-4a



R2-1

For freeways posted greater than 65 mph, use the R2-4a speed limit sign with truck speed limit after all interchanges or locations except as noted below. Use appropriate speed limit values for each location. For freeways posted 70 mph or 75 mph, the truck speed is 65 mph. For all other posted speed limits, the truck speed is the same as the posted speed limit. The minimum speed is 55 mph on all freeways. For freeways posted 65 mph or lower, use the R2-1 speed limit sign displaying the appropriate speed on the sign (48" x 60").

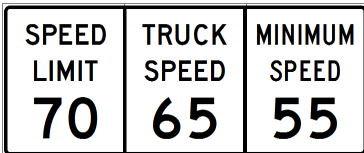

R2-4b

Use the R2-4b speed limit sign at entrances to the state, at the beginning of a freeway, and after freeway splits or merges where the freeway posted speed limit is 70 mph or 75 mph. For such locations where the freeway is posted 65 or lower, use the R2-4a speed limit sign with a truck speed limit the same as the speed limit. For freeways posted 55 mph, use the R2-1 speed limit sign displaying 55 on the sign.

For non-freeway, the 24-inch by 30-inch Speed Limit (R2-1) sign shall be used for all single lane roadways and multi-lane roadways with a speed limit of 35 mph or less. For multi-lane roadways with a speed limit of 40 mph or more, a 30-inch by 36-inch sign shall be used. This does not preclude the case of a 36-inch by 48-inch size sign when engineering judgment indicates the larger size is needed for effectiveness. On all roadways speed limit signs should be placed at least every ten miles.

LANE-USE CONTROL SIGNS

RIGHT (LEFT) LANE MUST TURN RIGHT (LEFT) signs are intended for use at roadside locations to prevent entrapment and help motorists select the appropriate lanes. In each case, one sign is required at the mandatory turn location and additional signs may be placed in advance at the beginning of the taper.

Where increased turning capacity is desired, turns may be permitted from the lane

¹⁷ SIGN – 150 Sign Support Selection Charts

adjacent to the mandatory turn lane. The DOUBLE TURN ARROW sign shall be used for this operation.

In a few cases, a separate lane may have been constructed to serve left or right-turning vehicles at more than one intersection. In this instance, supplemental street/road name panels may be used with RIGHT (LEFT) LANE MUST TURN RIGHT (LEFT) signs at advance locations where confusion may result from the use of RIGHT (LEFT) LANE MUST TURN RIGHT (LEFT) signs alone. Such supplemental panels should be placed below RIGHT (LEFT) LANE MUST TURN RIGHT (LEFT) signs and have the same width and color.¹⁸

NO TURN ON RED SIGNS

Although turn-on-red may be prohibited, it should not be arbitrarily disallowed. Engineering judgment, after carefully analyzing traffic conditions at the location, should be the basis for a turn-on-red prohibition. A prohibition should be considered only after its need has been fully established and less restrictive measures have been ruled out. At some locations, conditions may require only part-time prohibition of turn-on-red.

Installation of a NO TURN ON RED (R10-11) sign should be considered when an engineering study finds one or more of the following criteria exist:

1. Intersections have sight distance restrictions to the left which inhibit right turns from that approach.
2. More than three right turn-on-red crashes reported in a 12-month period for the approach.
3. A signalized intersection with a railroad crossing and pre-signal within 100 feet shall have a NO TURN ON RED sign if one of the following conditions exist:
 - a. Insufficient clear storage distance for a design vehicle between the signalized intersection and the railroad crossing.
 - b. The highway-rail crossing does not have gates.

When used, the NO TURN ON RED sign shall be located above or adjacent to the traffic signal or as close as possible to the point where the turn is made, or at both locations. One or more of the signs should be visible to a driver intending to turn, at the point where the turn is made. If possible, far right installations should be considered to supplement the near right signs. Overhead illuminated NO TURN ON RED signs may be considered when conditions such as high pedestrian concentrations, predominant crash patterns, multi-phase signals, and limited sight distance exist.

Alternatives to NO TURN ON RED signs include, but are not limited to the following:

1. If capacity issues exist, but there still is a safety concern with right turns and the opposing left turns, a disappearing NO RIGHT TURN ON RED case sign can be installed where there is an opposing left-turn phase. This case would

¹⁸ Appendix B-7: [Lane Use Control Signs](#)

- require an exclusive right-turn lane.
2. Install right-turn-on-green arrow with supplemental NO TURN ON RED signs. This would only apply at locations where there is a left-turn phase on the cross street. This case would require an exclusive right-turn lane.

The Traffic Signals Unit should be contacted to assist in evaluating the above alternatives before proceeding.

For further factors to be considered when evaluating the need for the NO TURN ON RED sign, see Section 2B.54, MMUTCD.¹⁹

TWO-WAY, LEFT-TURN ONLY SIGNS

Suggested spacing of the roadside CENTER LANE sign should be approximately a continuous 1/4 mile in urban areas, and a continuous 1/2 mile in rural areas. The sign size depends on the prominence of other highway and commercial signs, and on roadway width. Presence of readily visible pavement markings is important when roadside signs are used.

There are conditions, such as dense traffic, high percentage of commercial vehicles, roadside parking, or insufficient space for ground-mounted signs, where span-mounted overhead TWO-WAY LEFT ONLY and BEGIN CENTER LANE signs should be considered. In situations where the continuous left-turn lane is not in the center of the roadway, CENTER LANE signs cannot be used because the legend on the sign refers to the center lane. If the two-way turning lane is not in the center of the roadway, then overhead span wire signs should be placed at the beginning of the two-way turning lane or a ground mounted R3-9 series sign may be used if an overhead span wire is not feasible.²⁰

NO PASSING CONTROL SIGNS

NO PASSING ZONE and DO NOT PASS signs should be placed at the beginning of sight restricted zones, where there are added lanes, at lane drops, and on passing relief lanes where there is a solid yellow pavement marking or double yellow pavement markings. The PASS WITH CARE sign should be placed at the end of the no passing zone.

In setting no passing zones, the posted speed limit shall be used to determine the appropriate sight distance from Table 3B-1. Gaps at or below the distances as shown in Table 3B-1, Minimum Passing Sight Distances for No-Passing Zone Markings, MMUTCD should be closed.^{21 22}

In establishing the above-referenced no passing zones, discretion and engineering judgment should be exercised. There may be specific situations and/or locations where

¹⁹ [MMUTCD Part 2B – Regulatory Signs, Barricades and Gates \(2B-53 page 53\)](#)

²¹ [MMUTCD Part 3B – Table 3B-1 Table 3B-1. Minimum Passing Sight Distances for No-Passing Zone Markings \(Sect 3B.02 page 352\)](#)

²² Appendix F: [No Passing Zones](#)

adjustments to the distances/values given in MMUTCD Table 3B-1 are warranted. In some cases, where prior experience and observation have shown that operating speeds below the posted speed limit can routinely be anticipated, shorter minimum passing sight distances may be justified. Examples of such locations may include extended upgrades where heavy vehicles have difficulty maintaining the posted speed, or areas with a high prevalence of slow-moving commercial vehicles and/or farm equipment. Conversely, in other cases, where it is known that operating speeds tend to be greater than the posted speed limit, longer minimum passing sight distances may be justified.

PASSING LANE TRAFFIC CONTROL SIGNS

Where passing lanes have been constructed to accommodate trucks and/or slower moving vehicles, signing and pavement markings should be installed. The DO NOT PASS WHEN OPPOSING TRAFFIC PRESENT sign is no longer used. Instead, the triple arrow diamond warning sign should be placed facing the single lane traffic.^{23, 24}

NO PASSING CONTROL AT RAILROAD CROSSING

Where the railroad signs or tracks coincide with (or are very near) the limits of the no passing zone, the NO PASSING ZONE and DO NOT PASS signs should be placed approximately 250 feet in advance of the Railroad Advance symbol sign. The PASS WITH CARE sign should be placed approximately 100 feet beyond the crossing.

When a sight-restricted no-passing zone occurs in combination with a railroad crossing, the no passing control signs should be placed per the sight restriction and not just placed approximately 250 feet in advance of the Railroad Warning symbol sign, and approximately 100 feet beyond the tracks. Passing control signs should not be mounted on the same supports as the railroad crossing signs, nor should they be placed so closely to the railroad crossing signs as to obstruct the view of them.

RAILROAD CROSSBUCK SIGNS

At signalized railroad grade crossing locations, all CROSSBUCK, NUMBER OF TRACKS, and STOP ON RED SIGNAL signs, whether they are initial sign installations or replacements, are to be replaced by the appropriate railroad company.

At non-signalized railroad grade crossing locations, all CROSSBUCK, STOP, or YIELD, and NUMBER OF TRACKS signs, whether they are initial sign installations or replacements, are not to be replaced on Department construction contracts.

The Department needs to acquire a permit from the Railroad Authority for any work within the railroad right of way. Any request for permits should be referred to the

²³ Appendix B-21: [Traffic Control Plan for Passing Lanes at Variant Locations](#)

²⁴ Appendix B-22: [Traffic Control Plan for Passing Lanes at Same Location](#)

Railroad Grade Separations Engineer in the Infrastructure Development Section of the [Office of Rail](#).

WINTER PARKING RESTRICTIONS SIGNS

The Winter Parking Restrictions sign can be used on state and county highways when appropriate. Winter Parking Restriction signing is not mandatory and only those counties with a history of significant snow fall should use this sign. The parking restriction will be effective during the winter months noted in the local ordinance for the municipality from December 1 to March 31 and may restrict parking for different hours and different dates in different counties. When installed, the sign will be located at the corporate limits of the county on all state trunklines and county primary highways. A modified version of the sign could be used at village or city limits where local ordinances are in place for winter parking restrictions.

When a request for the Winter Parking Restriction sign is received from a county, the Region/TSC Traffic and Safety Representative will determine the county's cost for installing the sign and post. All maintenance costs, thereafter, shall be the Department's expense. The Region/TSC will contact Region Finance Personnel and follow the process for invoicing and reimbursement.²³

NO CAMPING OR OVERNIGHT PARKING SIGNS

The NO CAMPING OR OVERNIGHT PARKING sign may be used at rest areas, welcome centers, roadside parks, scenic turnouts, and crash investigation sites. Use as appropriate where there is a history of motorists using these facilities as campgrounds.



LOCAL PARKING ORDINANCE SIGNS

Incorporated communities that enact ordinances restricting all night parking are required by the MVC to post appropriate signs along highways at their corporate limits.

All local ordinance signs required by the MVC to be located along state trunkline highways shall be installed and maintained by state forces.

Where freeway interchanges are located within a corporate limit, local ordinance signs may be installed at one of the following locations:

1. Along the freeway mainline in urban areas
2. Along all exit ramps
3. On the crossroad near the interchange

Choice of location should be based upon the number and length of exit ramps, as well as to the number of spacing of interchanges.

WARNING SIGNS

Table 2. Standard Warning Sign Sizes (page 1 of 2)

Sign	Sign Code	Non-Freeway	Expressway	Freeway
Horizontal Alignment	W1-1, 2, 3, 4, 5	36 x 36	36 x 36	48 x 48
One-Direction Large Arrow	W1-6	48 x 24	48 x 24	60 x 30
Two-Direction Large Arrow	W1-7	48 x 24	48 x 24	60 x 30
Chevron Alignment	W1-8	24 x 30	36 x 48	Ramp 45-55 mph 36 x 48 Ramp 40 mph or less 24x30
Combination Horizontal Alignment/ Intersection	W1-10, 10a, 10b, 10c, 10d, 10e	36 x 36	36 x 36	48 x 48
Hairpin Curve	W1-11	36 x 36	36 x 36	48 x 48
Truck Rollover	W1-13	36 x 36	36 x 36	48 x 48
270 Degree Loop	W1-15	36 x 36	36 x 36	48 x 48
Intersection Warning	W2-1, 2, 3, 4, 5, 6, 7, 8	36 x 36	36 x 36	-
Advanced Traffic Control	W3-1, 2, 3	36 x 36	36 x 36	48 x 48
Reduced Speed Limit Ahead	W3-5	36 x 36	36 x 36	48 x 48
XX MPH Speed Zone Ahead	W3-5a	36 x 36	36 x 36	48 x 48
Reduced Speed Zone Ahead	W3-5b	36 x 36	36 x 36	48 x 48
Merging Signs	W4-1, 2, 3	36 x 36	36 x 36	48 x 48
Cross Traffic Does Not Stop (plaque)	W4-4P, 4aP, 4bP	30 x 15	36 x 18	-
Entering Roadway Merge	W4-5	36 x 36	36 x 36	48 x 48
Entering Roadway Added Lane	W4-6	36 x 36	36 x 36	48 x 48
Road Narrows	W5-1	36 x 36	36 x 36	48 x 48
Narrow Bridge	W5-2	36 x 36	36 x 36	48 x 48
Divided Highway	W6-1	36 x 36	36 x 36	-
Divided Highway Ends	W6-2	36 x 36	36 x 36	-
Two Way Traffic	W6-3	36 x 36	36 x 36	-
Triple Arrow	W6-5	36 x 36	36 x 36	48 x 48
Hill	W7-1, 1a	36 x 36	36 x 36	48 x 48
Bump or Dip	W8-1, 2	36 x 36	36 x 36	48 x 48
Bridge Ices Before Road	W8-13	36 x 36	36 x 36	48 x 48
Left (Right) Lane Ends	W9-1	36 x 36	36 x 36	48 x 48
Lane Ends Merge Left (Right)	W9-2	36 x 36	36 x 36	48 x 48

Table 2. Standard Warning Sign Sizes (page 2 of 2)

Sign	Sign Code	Non-Freeway	Expressway	Freeway
RR Grade Crossing Advance	W10-1	36 dia.	36 dia.	-
RR Grade Crossing Side Road (crossroad)	W10-2	36 x 36	36 x 36	-
RR Grade Crossing Side Road (T right or left)	W10-3	36 x 36	36 x 36	-
RR Grade Crossing Side Road (T intersection)	W10-4	36 x 36	36 x 36	-
Bicycle	W11-1	36 x 36	36 x 36	-
Pedestrian	W11-2	36 x 36	36 x 36	-
Deer Crossing	W11-3	36 x 36	36 x 36	48 x 48
Farm Vehicle	W11-5, 5a	36 x 36	36 x 36	-
Snowmobile	W11-6	36 x 36	36 x 36	-
Emergency Vehicle	W11-8	36 x 36	36 x 36	-
Truck	W11-10	36 x 36	36 x 36	-
Horse Drawn Vehicle	W11-14	36 x 36	36 x 36	-
Bicycle/Pedestrian	W11-15	36 x 36	36 x 36	-
Trail Crossing	W11-15a	36 x 36	36 x 36	-
Double Arrow	W12-1	36 x 36	36 x 36	-
Low Clearance (with arrows)	W12-2	36 x 36	36 x 36	48 x 48
Low Clearance	W12-2aP	24 x 18	36 x 24	48 x 30
Low Clearance (overhead)	W12-3	72 x 21	72 x 21	96 x 24
Low Clearance (overhead with arrow)	W12-3a	102 x 36	102 x 36	136 x 30
Advisory Speed (plaque)	W13-1P	24 x 24	24 x 24	30 x 30
Advisory Exit or Ramp Speed	W13-2, 3	24 x 30	36 x 48	-
Advisory Exit or Ramp Speed (freeway)	W13-6, 7	-	-	48 x 84
No Passing Zone (pennant)	W14-3	48 x 48 x 36	48 x 48 x 36	-
Share the Road (plaque)	W16-1P	18 x 24	24 x 30	-
XX Feet (plaque)	W16-2P	24 x 18	24 x 18	-
XX Miles (2-line plaque)	W16-3P	30 x 24	30 x 24	-
XX Miles (1-line plaque)	W16-3aP	30 x 12	30 x 12	-
Next XX Feet (plaque)	W16-4P	30 x 24	30 x 24	-
Supplemental Arrow (plaque)	W16-5P, 6P	24 x 18	24 x 18	-
Downward Diagonal Arrow (plaque)	W16-7P	36 x 18	36 x 18	-
Advance Street Name (1- line plaque)	W16-8P	Varies x 12 Varies x 15	Varies x 12 Varies x 15	-
Advance Street Name (2- line plaque)	W16-8aP	Varies x 18 Varies x 21	Varies x 18 Varies x 21	-
Ahead (plaque)	W16-9P	36 x 18	36 x 18	-
When Flashing (plaque)	W16-13P	24 x 18	24 x 18	-
Freeway Ends XX Miles	W19-1	-	-	180 x 60
Freeway Ends	W19-3	-	-	48 x 48

Notes: 1. Larger signs may be used when appropriate.
2. Dimensions in inches are shown as width x height.

ADVANCED CROSSROAD / SIDE ROAD SIGNS

A crossroad or side road symbol may be used in advance of an intersection to indicate the presence of an intersection and the possibility of turning or entering traffic that may be a hazard to trunkline traffic.

A black on yellow advanced road name sign plaque may be used to supplement the advanced crossroad or side road sign. C-series highway font shall be used for the plaque with lower case letters and initial upper-case letters. Clearview font shall not be used for the plaque. The black on yellow road name sign shall not be used with a green and white advance road name sign.

RAILROAD ADVANCE SIGNS

The Department is responsible for placing and maintaining advance signing at all railroad at-grade crossings on the state trunkline system. The Department is responsible for signing of a railroad at-grade crossing on a side road. If the side road railroad is within 100 feet of the trunkline there shall be either a crossroad or side road railroad sign. On divided roadways the signs shall be placed on each side of the roadway for both directions of traffic.²⁶



ADVANCE WARNING SIGNS AND ADVANCE HORIZONTAL ALIGNMENT SIGNS

Advance warning signs used for complex maneuvers, where the driver must use extra time to adjust speed and change lanes, should be placed per column A in Table 3. The types of signs that fall into this category are listed in Table 4. For a lane drop situation use the distances listed in Table 3. If there is not enough distance per Table 3 adjust sign placement per Minimum Advance Placement Distance for Signing Required in Condition A Scenario.²⁷

Advance traffic control signs such as the Stop Ahead, Yield Ahead, or Signal Ahead shall be installed on an approach to a primary traffic control device that is not visible for a sufficient distance to permit the road user to respond to the device.

They may also be used for additional emphasis of the primary traffic control device, even when the visibility distance to the device is satisfactory.^{28, 29} The signs should be placed per Table 3. An advance street name plaque may be installed below an advance traffic control sign.

²⁶ MMUTCD: [Part 8](#) (Page 14) [MMUTCD Section 8B.06 Grade Crossing Advance Warning Signs](#)

²⁷ Appendix B-28: [Minimum Advance Placement Distance for Signing Required in Condition A Scenario](#)

³¹ Appendix B-26: [Example Approach Signing at Junction of 2 Non-Freeway Trunklines](#)

³² Appendix B-27: [Approach Signing for Non-Freeway Intersections](#)

Table 3. Minimum Advance Sign Placement Distance (ft)

Posted Speed (mph)	Condition A ¹	Condition B (mph)														
		0 ²	5 ³	10 ³	15 ³	20 ³	25 ³	30 ³	35 ³	40 ³	45 ³	50 ³	55 ³	60 ³	65 ³	70 ³
25	325	155	125	100 ⁴	100 ⁴	100 ⁴										
30	460	200	150	115	100 ⁴	100 ⁴	100 ⁴									
35	565	250	185	125	115	100 ⁴	100 ⁴	100 ⁴								
40	670	305	225	150	135	125	120	115	100 ⁴							
45	775	360	280	200	185	175	160	150	125	100 ⁴						
50	885	425	350	275	250	225	215	200	175	150	100 ⁴					
55	990	495	425	350	335	325	300	275	240	200	175	150				
60	1100	570	510	450	425	400	375	350	315	275	240	200	150			
65	1200	645	585	525	515	500	475	450	415	375	315	275	215	150		
70	1250	695	675	625	615	600	575	550	515	475	425	375	315	250	150	
75	1350	730	745	710	705	695	685	675	640	600	550	500	425	350	275	200

NOTES:	
1	Typical conditions are locations where the road user must use extra time to adjust speed and change lanes in heavy traffic because of a complex driving situation. Typical signs are Merge and Right Lane Ends. For other examples of signs for this condition, see "Condition A, Complex Maneuvers" in Table 4.
2	Typical condition in the warning of a potential stop situation. Typical signs are Stop Ahead, Yield Ahead, Signal Ahead, and Intersection Warning signs. For other examples of signs for this condition, see "Condition B, Stop Condition" in Table 4.
3	Typical conditions are locations where the road user must decrease speed to maneuver through the warned condition. Typical signs are Turn and Curve signs with advisory speed plaques. For other examples of signs for this condition, see "Condition B, Decelerate to Indicated Advisory Speed" in Table 4.
4	The minimum advance placement distance is listed as 100 feet to provide adequate spacing between signs.

Warning signs should not be placed at distances more than twice the minimum shown in Table 3. If signs must be placed at more than twice the minimum distance they should be accompanied by a supplementary plaque.

Some signs that are listed under the Stop Condition section in Table 4 are marked with a double asterisk **. These signs may be used for a segment of roadway rather than a specific point. If signing for a specific point the sign should be placed at least the minimum distance back from that point. If signing for a segment of roadway, such as a Bear Crossing symbol with a Next 5 Miles plaque, the signs should be placed at each end of the segment, not in advance.

Warning signs that are listed for a stop condition should be placed so that they are visible before a curve, or a steep slope or hill. If a sign that may require a driver to stop suddenly is placed where it is only visible in the middle of a curve or on a steep slope or hill the driver may be adversely affected. Refer to the MMUTCD for the specific use of each sign listed in Table 4.

Advisory speed plaques shall not be used on signs that are listed as a stop condition in Table 4.

In order to inform drivers of changes in the horizontal alignment of a roadway, it may be necessary to place Turn, Curve, Reverse Turn, Reverse Curve, or Winding Road signs in advance of such changes. Some changes in horizontal alignment are obvious and no signs may be needed. Other changes in alignment, however, may be more pronounced or hidden from view. In these cases, advance warning signs may be necessary.

Table 4. Part 1. Applicable Warning Signs

Placement Condition	Category	Sign Code	Sign or Plaque
A	Complex Maneuvers	W4-1	Merge
		W4-2	Lane Ends
		W4-3	Added Lane
		W4-5	Entering Roadway Merge
		W4-5P	NO MERGE AREA
		W4-6	Entering Roadway Added Lane
		W4-7	THRU TRAFFIC MERGE LEFT
		W9-1*	RIGHT LANE ENDS
		W9-2*	LANE ENDS MERGE LEFT
		W9-7	RIGHT LANE EXIT ONLY AHEAD
B	Stop Condition	S1-1	School
		W1-10	Horizontal Alignment
		W1-10a	Combination Horizontal Alignment Curve/Cross Road
		W1-10b	Combination Horizontal Alignment Curve/Fork
		W1-10c	Combination Horizontal Alignment Curve/Skewed Side Road
		W1-10d	Combination Horizontal Alignment Reverse Curve/Side Road
		W1-10e	Combination Horizontal Alignment Reverse Curve/Cross Road
		W2-1	Cross Road
		W2-2	Side Road
		W2-3	45 Degree Side Road
		W2-4	T Symbol
		W2-5	Y Symbol
		W2-6	Circular Intersection
		W3-1	Stop Ahead
		W3-2	Yield Ahead
		W3-3	Signal Ahead
		W3-6	DRAW BRIDGE
		W5-3	ONE LANE BRIDGE
		W7-4dP	SAND
		W7-4eP	GRAVEL
		W8-5aP	ICE
		W8-5cP	EXCESS OIL
		W8-13	BRIDGE ICES BEFORE ROAD
		W8-14	FALLEN ROCKS
		W8-18	ROAD MAY FLOOD
		W10-1	Rail Grade Crossing Advance Warning
		W10-2	Rail Grade Crossing Advance Warning Cross Road
		W10-3	Rail Grade Crossing Advance Warning Side Road
		W10-4	Rail Grade Crossing Advance Warning T
		W10-5	Low Ground Clearance Rail Grade Crossing
		W10-5P	LOW GROUND CLEARANCE

*See Figure 24 Minimum Advance Placement Distance for Signing Required in Condition A Scenario

Table 4. Part 2. Applicable Warning Signs

Placement Condition	Category	Sign Code	Sign or Plaque
B	Stop Condition	W11-1	Bicycle Traffic
		W11-2	Pedestrian Traffic
		W11-3**	Deer traffic
		W11-4**	Cattle Traffic
		W11-5**	Farm Machinery Traffic
		W11-5a**	Farm Machinery Traffic
		W11-6**	Snowmobile Traffic
		W11-7**	Equestrian Traffic
		W11-8	Emergency Vehicle
		W11-9	Handicapped
		W11-10	Truck Crossing
		W11-10a	TRUCK CROSSING
		W11-11	Golf Cart Crossing
		W11-12P	EMERGENCY SIGNAL AHEAD
		W11-14**	Horse and Buggy Traffic
		W11-15	Combination Bike and Pedestrian Crossing
		W11-15P	TRAIL X-ING
		W11-15a	TRAIL CROSSING
		W11-16**	Large Animal-Bear
		W11-17**	Large Animal-Sheep
		W11-18**	Large Animal-Bighorn Sheep
		W11-19**	Large Animal-Donkey
		W11-20**	Large Animal-Elk
		W11-21**	Large Animal-Moose
		W11-22**	Large Animal-Wild Horse
		W11-23**	ORV Crossing
		W14-1	DEAD END
		W14-1a	DEAD END w/ arrow
		W14-2	NO OUTLET
		W14-2a	NO OUTLET w/arrow
	W14-2b	ROAD ENDS	
	Decelerate to Indicated Advisory Speed	S4-5	School Speed Reduction
		S4-5a	XX MPH SCHOOL ZONE AHEAD
		W3-5	Speed Reduction
W3-5a		XX MPH SPEED ZONE AHEAD	
W13-1P		Advisory Speed	
W13-2		EXIT Advisory Speed	
W13-3		RAMP Advisory Speed	
W13-6		EXIT Advisory Speed	
W13-6a		EXIT Advisory Speed	
W13-7		RAMP Advisory Speed	
W13-7a	RAMP Advisory Speed		

** Signs that may mark the beginning of a segment. See guidance for placement.

Warning signs that are likely to be used with advisory speed plaques are Turn, Curve, Reverse Turn, Reverse Curve, Winding Road, Hairpin Curve, Truck Rollover, and 270 Degree Loop. Refer to the MMUTCD for the specific use of each sign listed. The sign should be placed as shown in Appendix B-31.³⁰

If the Combination Horizontal Alignment Advisory Speed sign (W1-1a and W1-2a) is to be used, it shall be used as a supplement to the advanced Turn or Curve sign and is to be placed at the beginning of the turn or the curve. The advisory speed displayed should be determined using the following recommended engineering practices.

The Advisory Speed (W13-1P) plaque may be used to supplement many warning signs to indicate the advisory speed for a condition.

The use of the Advisory Speed plaque for horizontal curves shall be in accordance with the information shown in Table 5 below. The Advisory Speed plaque shall also be used where an engineering study indicates a need to advise road users of the advisory speed for other roadway conditions. If used, the Advisory Speed plaque shall carry the message XX MPH. The speed displayed shall be a multiple of 5 mph. Except in emergencies or when the condition is temporary, an Advisory Speed plaque shall not be installed until the advisory speed has been determined by an engineering study.

The Advisory Speed plaque shall only be used to supplement a warning sign and shall not be installed as a separate sign installation.

The advisory speed shall be determined by an engineering study that follows established engineering practices.

Among the established engineering practices that are appropriate for the determination of the recommended advisory speed for a horizontal curve are the following:

1. An accelerometer that provides a direct determination of side friction factors.
2. A design speed equation.
3. A traditional ball-bank indicator using the following criteria:
 - a. 16 degrees of ball-bank for speeds of 20 mph or less,
 - b. 14 degrees of ball-bank for speeds of 25 to 30 mph,
 - c. 12 degrees of ball-bank for speeds of 35 mph and higher.

The 16, 14, and 12 degrees of ball-bank criteria are comparable to the current AASHTO horizontal curve design guidance. Research has shown that drivers often exceed existing posted advisory curve speeds by 7 to 10 mph.

4. Field method for the determination of advisory speed on curves.³¹

The advisory speed should be determined based on free-flowing traffic conditions. Because changes in conditions, such as roadway geometrics, surface characteristics, or

³⁰ Appendix B-29: [Minimum Advance Placement Distance for Curve Signing Required in Condition B: Decelerate to Indicated Advisory Speed](#)

³¹ Appendix B-12: [Determination of Advisory Speeds on Curves](#)

sight distance, might affect the advisory speed, each location should be evaluated periodically or when conditions change.

For freeway ramps with a speed reduction of 40 MPH or more, a ground mounted warning sign, as required in Table 5, should be supplemented with an overhead warning sign and an exit gore warning sign plaque.³² A high crash history may also warrant the additional warning signs. Rest area ramps should include a warning sign for speed also.

All horizontal alignment signs shall have reflective panels added to the sign supports. This refers to all signs in the W1 series. Follow the recommendations in 12SP810M.³³ Information on construction can be found in Section 810 of the Standard Specifications for Construction.³⁴

Table 5. Horizontal Alignment Sign Selection

TYPE OF HORIZONTAL ALIGNMENT SIGN	DIFFERENCE BETWEEN SPEED LIMIT AND ADVISORY SPEED				
	5 mph	10 mph	15 mph	20 mph	25 mph or more
Turn, Curve, Reverse Turn, Reverse Curve, Winding Road, and Combination Horizontal Alignment/Intersection	Recommended	Required	Required	Required	Required
Advisory Speed Plaque	Recommended	Required	Required	Required	Required
Chevrons and/or Directional large Arrow	Optional	Recommended	Required	Required	Required
Ground Mounted Exit Speed and Ramp Speed on exit ramp	Optional	Optional	Recommended	Required	Required

Note: Required means that the sign and/or plaque shall be used, recommended means that the sign and/or plaque should be used, and optional means that the sign and/or plaque may be used.

CHEVRON ALIGNMENT SIGNS

Chevron Alignment signs are intended as a supplement to the standard delineator treatment and as an alternate or supplement to the One Direction Large Arrow sign. When used, Chevron Alignment signs shall be installed on the outside of curves or turns where run-off-roadway crashes are frequent and additional emphasis on delineation is desired. When a One Direction Large Arrow sign is used in combination with Chevron Alignment signs, the One Direction Large Arrow sign should be placed in line with and

³² Appendix B-10: [Advisory Speed Signs for Freeway Ramps](#)

³³ [Michigan DOT Special Provisions](#)

³⁴ [Michigan DOT Standard Specifications for Construction](#)

at approximately a right angle to approaching traffic. The Chevron Alignment signs are to be properly spaced preceding and following the One Direction Large Arrow sign. On non-freeways a One Direction Large Arrow sign should always be used (and placed in target position) when using a series of chevrons.

Chevron alignment signs need to be positioned to provide 500 feet of visibility. At minimum, the motorist must have a continuous view of two signs with low beam headlights along the curved alignment until the change in alignment eliminates the need for Chevron alignment signs. The near edge of the sign should be located a minimum of three feet from the shoulder hinge point, three feet from the face of straight-faced curb, or three feet from the back of guardrail posts or other positive barrier. The three-foot lateral offset is only a minimum dimension. Signs should be offset as far as practical, up to 17 feet from the edge of pavement except when located behind guardrail or other positive barrier where the three-foot offset is desirable.³⁵

REFLECTIVE STRIPS ON SIGN POSTS

All W1 series signs, and midblock Pedestrian, Bike, Trail, and School Crossings shall have reflective strips installed on the posts. Stop Ahead and Yield Ahead, if used, and if reflective strips are used on the STOP and YIELD signs³⁶, shall have reflective strips. The sheeting of the reflective panel must match the background color of the sheeting of the sign mounted on the post.

ADVANCED SNOWMOBILE AND ALL TERRAIN VEHICLE (ATV) CROSSING SIGNS

When requested by a governmental agency, an advance crossing sign should be placed at Michigan Department of Natural Resources and Environment (MDNRE) sanctioned trail crossings with sight distances less than intersection sight distance for the posted speed of the roadway. See the department's Sight Distance Guidelines for further information on intersection sight distance.

For crossings exhibiting a crash pattern, the Region Traffic and Safety Representative should contact the MDNRE to determine if the crossing can be relocated or modified to address the crash pattern. For those locations exhibiting a crash pattern where no revisions can be made, the advance crossing sign should be placed to inform motorists of possible crossings or entries into the roadway.

Advance warning signs may also be placed on engineering judgment upon a joint review by MDOT and MDNRE. Advance warning signs used may be the Snowmobile warning sign, the ATV warning sign, or if a combined snowmobile and ATV trail, the TRAIL CROSSING text sign.

Snowmobile³⁷ and ATV³⁸ trail maps are available from the Michigan Department of Natural Resources and Environment website.

³⁵ Appendix B-9: [Roadway Delineation](#)

³⁶ [SIGN-145: All Way Stop and Cross Traffic Does Not Stop Conditions](#)

³⁷ [DNR Snowmobile Trails](#)

³⁸ [DNR ATV Trails](#)

Use the appropriate advance warning sign as follows:

<u>Trail</u>	<u>Sign</u>
Snowmobile Only	W11-6 (Snowmobile Symbol)
ATV Only	W11-23 (ATV Symbol)
Snowmobile/ATV (multiple uses)	W11-15a (Trail Crossing Legend)

GUIDE SIGNS

ADVANCE GUIDE/EXIT DIRECTION SIGNS

When the difference in length between the exit panel and the Advance Guide/Exit Direction sign is 3 feet or less, increase the width of the exit panel to match that of the Advance Guide/Exit Direction sign and right justify the legend. Where necessary, the exit panel may match the length of the Advance Guide/Exit Direction sign to cover the arms or box of the overhead sign structure. The minimum sign height for a type E cantilever is 6.5 feet.

The following govern design of overhead exit direction signs:

1. All signs shall carry the exit number (if used), the route number, cardinal direction, and destination with an appropriate upward slanting arrow.
2. The message "EXIT ONLY" in black on a yellow panel shall be used on the overhead exit direction sign to advise drivers of a lane drop situation.
3. The use of an advisory speed sign, E11-1e (Exit) or E11-1f (Ramp), on the overhead exit direction sign is limited to an extreme speed reduction of 40 mph or more below the posted speed limit of the mainline or a documented history of rollover or run-off-the-roadway crashes. The use of overhead advisory speed limit signs is supplemental to the Exit or Ramp Advisory Speed signs.
4. For freeway interchanges with no return entrance ramp(s), the message "NO RE-ENTRY _____ BOUND" (black on a yellow panel) shall be used on the Advance Guide and Exit Direction signs.

SUPPLEMENTAL GUIDE SIGNS

Supplemental guide signs are used to guide motorists who are seeking a specific traffic generator facility. Installation of supplemental signs may be justified when visitation or attendance volumes are high and a significant percentage of motorists seeking a traffic generator are unfamiliar with its location and access routes. Supplemental guide signs are not intended to advertise or promote a facility, or to increase its visitation or attendance volumes. "As per the Federal Manual on Uniform Traffic Control Devices, both Specific Service (Logo) Signs and Tourist Oriented Directional Signs (TODS) provide business identification and directional information for essential motorist services

and for businesses deriving a major portion of income and/or visitors from motorists not residing in the immediate area respectively. Both sign programs are mandated by Michigan statute.”

Supplemental guide signs can reduce the effectiveness of other essential signing. For this reason, the Department has established minimum warrants for such signing which considers such factors as area population, attendance, interchange complexity, distance from the highway, and the importance of the destination or facility. For warrants, see the Guidelines for Signing on State Trunkline Highways.

Veterans Administration hospitals and clinics shall be signed for if a request is received from the individual facility. A supplemental guide sign for a veterans’ cemetery may be placed on a federal-aid highway according to the Veterans’ Memorial Preservation and Recognition Act of 2003.

Placement of supplemental guide signs for a traffic generator should be limited to the closest state highway providing the most direct and appropriate access. Signing which would require a motorist to travel on the crossroad beyond another state highway and/or through a community is not allowed. Supplemental signs shall not be installed in advance of an interchange connecting two freeways or at an intersection of two non-freeways unless otherwise permitted by the Guidelines for Signing on State Trunkline Highways.

Supplemental guide signs for traffic generators located within a community should not be installed outside the corporate limits of that community. A motorist traveling from a rural area must first be guided to the community before having need for traffic generator signing. The standard guide signing for communities currently serves this primary function. An exception to this rule may be made for freeways when it becomes necessary to differentiate between multiple interchanges serving the same community. In that case, supplemental guide signs may be allowed outside the corporate limits in order to guide traffic to the most efficient access route to a facility. Refer to the section on Traffic Generator Signing for more specific information.

NON-FREEWAY GUIDE SIGNS

When there is more than one destination on a sign, the closest destination lying straight ahead shall be at the top of the sign or assembly, and below it the closest destinations to the left and to the right, in that order. If more than one destination is displayed in the same direction, the name of a nearer destination shall be displayed above the name of a destination that is further away. The longest length destination shall be centered, and if there is more than one destination, the smaller destination(s) shall be justified according to Table 6. Examples of arrow and legend placement for guide signs can be found in the Michigan Standard Highway Signs (SHS) Book.

Table 6. Non-Freeway Directional Guide Sign Arrow Placement and Legend Justification

Number of Destinations Per Arrow	Arrow Placement		Legend Justification	
	Thru or Left	Right	Thru or Left	Right
One	Left side If a thru arrow is above a left arrow, center the thru arrow over the left arrow	Right side	Left side	Right side
Two	Left side One shared arrow placed between destinations as shown in the SHS manual	Right side One shared arrow placed between destinations as shown in the SHS manual	Left side	Right side
One destination requiring two lines of legend	Left side One shared arrow placed between lines of legend as shown in the SHS manual	Right side One shared arrow placed between lines of legend as shown in the SHS manual	Centered	Centered

CONTROL CITIES FOR DIRECTIONAL SIGNING

A maximum of three destinations are permitted on the Destination and Distance sign. Only one sign shall be placed prior to the next interchange. If there are two destinations, the top one should be the next city or village on the route. The bottom line should be the next control city (either major or minor). If there are three destinations used, the top is always the nearest, the second is the nearest city or village or the nearest minor control city, and the third line is the nearest major control city.³⁹

The distance shown on the sign should be to a well-defined central area or central business district where one exists. In other cases, the layout of the community should be considered in relation to the highway being signed and the decision based on where it appears that most drivers would feel that they are in the center of the community in question.

The next major control city shall remain the same on all successive signs throughout the length of the route until that destination is reached. There are circumstances, however, under which more than one distance point may properly be designated; for example,

³⁹ [Guidelines for Signing on State Trunkline Highways, page 21](#)

where the route divides at some distance ahead to serve two destinations of similar importance. If these two destinations cannot appear on the same sign, alternating the two names on succeeding signs may be justified. On a route continuing into another state, destination(s) in the adjacent states should be shown.

STREET NAME AND ADVANCE STREET NAME SIGNS

Street name signs (D3-1) located at the point of a street/highway intersection are the responsibility of the local governmental agency having jurisdiction at the location. When placed above stop signs, the D3-1 shall be mounted six inches above the stop sign and use upper and lower-case letters. D3-1 street name signs should be placed on their own supports, if possible.

On arterial highways in rural areas, Advance Street Name signs (D3-2) should be used in advance of all signalized intersections and in advance of all intersections with exclusive turn lanes. They may also be used at major paved crossroads. In urban areas, Advance Street Name signs should be used in advance of all signalized intersections on major arterial streets, except where signalized intersections are so closely spaced that advance placement of the signs is impractical. The lettering for names of streets shall be lower-case with initial upper-case letters. The road name shall be supplemented with a description, such as NEXT INTERSECTION, 2ND INTERSECTION, NEXT SIGNAL, etc. The supplemental description is required for rural arterials with traffic signals or exclusive left turn lanes and urban major arterials with traffic signals.



Advance Street Name signs may be used at the discretion of the Region or TSC at other locations than those noted above such as rural major paved crossroads, major county roads, arterials, and major collectors. The supplemental text, NEXT INTERSECTION or 2ND INTERSECTION, is optional if the region or TSC chooses to sign the intersection. Directional arrow(s) shall be placed to the right or left of the street name as described in Table 6. An arrow shall not be used for typical intersections with a crossroad on two approaches with the same street name. When the intersecting road is a crossroad with a different road name on either side of the trunkline or T-intersection arrow(s) shall be used next to each line of legend (street name). For these applications Type A arrows shall be used. Roadway types and locations can be found on National Functional Classification maps⁴⁰.

Black on yellow crossroad signs may be used instead of green advanced street name signs on non-freeways only. The black on yellow crossroad sign may be combined with an advanced street name plaque. The plaque is black on yellow and uses C-series highway font with lower case letters and initial upper-case letters. Clearview font shall

⁴⁰ [National Functional Classification Maps](#)

not be used for the plaque. The black on yellow crossroad warning and advance street name sign shall not be used with the white on green advance road name sign.

Placement and maintenance of all advance road name signs on state trunkline highways are the responsibility of the Department. The name chosen for display on any road name sign shall be the one officially designated by the county or the municipality having jurisdiction at the location.

If roadway conditions cause the Stop Ahead or Signal Ahead sign (for junctions having such signs) to be located beyond 1,000 feet, the JCT assembly may be eliminated, and a W16-8 plaque with the Junction name can be placed below the advanced warning sign.

TRAVEL INFORMATION RADIO STATION SIGNS

As an aid to motorists, municipalities and/or other governmental agencies often broadcast travel information on a local, limited distance, radio station. Signing for these stations may be provided by the Department if the following criteria are met:

- Travel information only (no music or advertising) is broadcasted.
- The station operates 24-hours a day, seven days a week, all year long. If the station operates only on a seasonal basis, the signs shall be removed during the off season at the cost of the requestor. Reinstallation of the sign will also be at the cost of the requestor. The Department will be responsible for removal and installation upon receipt of payment from the requestor. The above noted work will be scheduled and done by the Department.
- The request for signing comes from a municipality or other governmental agency.

Travel Information Radio Station Signing should be placed on trunkline approaches to the area of interest at the outer range of broadcast signal. Placement is limited to one sign per approach and shall be installed after the station is in operation. Per the MMUTCD only the numerical indication of the radio frequency and band shall be used to identify the radio station. No more than three frequencies shall be shown on one sign.

RECREATIONAL SIGNS

Signs should be erected at the request of the facility. Recreation signs are to be placed as space allows for DNR recognized parks and trails. The location shall be within 20 miles of the trunkline.

National parks⁴¹ are also permitted by the same guidelines as state facilities.

⁴¹ [National Parks in Michigan](#)

When symbols are used in recreational signs they should be placed in the face of the sign. The name of the facility should be shown above the symbols. A maximum of three symbols should be used. Priority should be given to activities that generate the greatest park traffic.



PUBLIC ACCESS should not be used as a sign legend. If there is a public access boat launch, instead use the name of the location and the boat launch symbol. For facility information, visit the MDNR's Boating Information System⁴².

HISTORICAL MARKER SIGNS

Historical Marker signs may be signed on non-freeways if the local governmental agency and/or local historical organization assumes the cost of fabrication, installation and maintenance of the signs ([Michigan Historical Markers](#)). Please refer to the Guidelines for Signing on State Trunkline⁴³ for more details.

MISCELLANEOUS INFORMATION SIGNS

Miscellaneous Information Signs are for identifying control points for activities that are clearly in the public interest. These include the Library symbol sign and Recycling Collection Center symbol signs.

CARPOOL LOT SIGNS

A Carpool Parking sign shall be used as a guide sign for carpool lots. This sign is only used for lots operated by the Department.⁴⁴

If traffic or geometric conditions, such as proximity to freeway ramps, do not permit locating the Carpool Parking signs in advance of the parking lot driveway, the two signs may be mounted on a single sign support at the driveway.

Within Department carpool parking lots, one of the two carpool parking sign options shall be used. For lots not served by a local transit authority, use the D4-4 sign. For lots served by a local authority, use their symbol on the D4-4a sign.

“Click It Or Ticket” seat belt signs are placed in carpool parking lots (24”). On Department construction contracts, these signs are fabricated by MDOT and the pay item used is “Installing MDOT Supplied Sign, Type III.”

⁴² [MDNR Boating Information System](#)

⁴³ [Guidelines for Signing on State Trunkline](#)

⁴⁴ Appendix B-20: [Carpool/Park-and-Ride Lots](#)

REST AREA / WELCOME CENTER SIGNS

Table 7. Sign Placement for Rest Area Freeway Exit Ramps

SIGN TYPE	SIGN CODE	LOCATION
Advance Guide with Next Area ___ Miles	D5-1 Series	One mile in advance of an exit.
Advance Guide/Exit Direction	D5-2	At the beginning of the deceleration lane. If the deceleration lane is less than 300', place 100' - 200' in advance of the ramp taper.
Advance Guide/Exit Gore	D5-2a	17' from edge of freeway pavement, 6' from edge of paved shoulder.
MALI Number	I13-2	On right support of Rest Area Exit Gore sign.
Directional Parking (Car/Car with trailer/Truck split)	R5-16	At the Rest Area gore.
Advisory speed	W13-30	500' (typical) from Car and Car w/Trailer/Truck split.
Do Not Enter	R5-1	Each side of ramp at gore facing parking area, opposite of traffic direction.
Wrong Way	R5-1a	Below each Do Not Enter (R5-1) sign on the same supports.

For the Advance Guide Sign location, the distance should always be measured from the 2-foot point of the exit gore. When the recommended distance is not practicable, the distance shown should be to the nearest 1/4 mile. Also, the Advance Guide, Exit Direction, and Exit Gore signs shall display an identical legend. Typical Rest Area/Welcome Center signing is shown in Appendix B.⁴⁵

For non-freeway rest areas, roadside parks, and scenic turnouts, a sign is placed 1/2 mile in advance and at the entrance for each direction. "Click It Or Ticket" seat belt signs are placed along Rest Area, Scenic Area, Roadside Park, and Welcome to Pure Michigan exits (42"). On Department construction contracts, these signs are fabricated by MDOT and the pay item used is "Installing MDOT Supplied Sign, Type II."

⁴⁵ Appendix B-30: [Typical Rest Area/Welcome Center Signing](#)

Table 8. Sign Placement for Rest Area Freeway Entrance Ramps

SIGN TYPE	SIGN CODE	LOCATION
Click It or Ticket	I13-1b	Along freeway entrance ramp prior to Merge sign.
Merge	W14-1	17' from edge of freeway pavement, 6' from edge of paved shoulder. Assume Merge sign is mainly used by freeway thru traffic, therefore, does not need to place two signs at any freeway entrance.
MALI Number	I13-2	On right support of Merge sign.
Turn Prohibition	R3-2	15' offset from edge of ramp pavement, 60' in advance of Merge Sign.*

* Offsets are noted if there is no guardrail. If guardrail is present, the minimum offset shall be 3' from back of guardrail posts.

Table 9. Additional Signs for Rest Area/Welcome Centers

	Sign Message	Sign Code
Optional	No Parking Symbol	R8-3
	One Way	R6-1
	Area May Be Under Surveillance	Special Detail
	Yield	R1-2
	State Police Parking	Special Detail
	Scenic Overlook	D6-1
	Welcome to Pure Michigan	I2-5 (MDOT Supplied Sign)
Required	Bus Parking	Detail A
	Dumping of Household Refuse Prohibited PA. 106 1963	Detail B
	Littering Property or Water Prohibited 324.89002 Act 451 of 1994	Detail B

ROADSIDE PARKS AND SCENIC TURNOUTS

Table 10. Sign Placement for Roadside Parks and Scenic Turnouts

SIGN TYPE	SIGN CODE	LOCATION
Advance Guide	D6-2	½ mile in advance of site in both directions.
Advance Guide/Exit Direction	D6-1/D6-3	At the beginning of the deceleration lane. If the deceleration lane is less than 300', place 100'-200' in advance of the ramp taper.

SNOWMOBILE USE ON COUNTY ROADS SIGNS

The purpose of these signs is to inform motorists entering a county or municipality on state highways that snowmobile routes are available. Snowmobiles may be operated on a highway in a county road system that is not normally snowplowed for vehicular traffic and on the plowed right-of-way or shoulder when no right-of-way exists on a snowplowed highway in the county road system, outside the corporate limits of a city or village that is designated and marked for snowmobile use by the county road commission. Upon the request of a county road commission that has designated all county roads outside the corporate limits of a city or village for snowmobile use, the Department shall erect, at the county road commission's expense and shall maintain in accordance with the MMUTCD, the snowmobile route sign together with the supplemental panel (7) stating "permitted on right-of-way or shoulder of all . . . (county name) roads – MCL 324.82119" at the county line on all state trunkline highways and county roads.

1. Local Requirements – A county is required to designate and mark all county roads outside of incorporated areas before the county road commission may request erection of snowmobile signs on state trunklines.

On officially designated city or village snowmobile routes, the snowmobile route sign unit should be erected at the corporate limits with supplemental panels to inform motorists and snowmobilers they are on a designated snowmobile route (Snowmobile and Route Begins panels).

Along the routes, the snowmobile route sign should be erected with appropriate directional panels to indicate the correct routing. All installation and maintenance costs of local snowmobile signs, except those on state trunklines entering counties, cities, or villages with snowmobile routes, will be the responsibility of the local governments.

2. State Trunklines – After a county has adopted an ordinance designating snowmobile routes and signed the routes as outlined above, the Department will install, upon request, the sign and supplemental panel (7) on state highways at the county or municipal entrances. The legend utilized on supplemental panel 7 should be PERMITTED ON RIGHT-OF-WAY OR

SHOULDER OF ALL (county name) COUNTY ROADS MCL 324.82119.

SLOGAN SIGNS

Local slogan signs should be removed at the end of service life and replaced, if requested, at the cost of the owners. This is typically performed when the parent sign is replaced but may be removed after one year. These signs should only be placed beneath boundary signs.

MEMORIAL / DEDICATED HIGHWAY SIGNS

Memorial / Dedicated Highway signs are designated in the state statute. The cost for installation and maintenance of the sign shall be paid for by the group requesting the sign. Contact information for the organization requesting the signs shall be submitted to the region traffic and safety representative.

In the past, Memorial / Dedicated Highway Signs have used a green background and a white legend. All such signs shall now use a brown background and a white legend. One sign in each direction shall be placed at the beginning of the dedicated highway segment. If requested, an additional sign shall be permitted for Memorial / Dedicated Highways over 50 miles and at increments of 50 miles thereafter. The signs should not appear on navigational guide signs, interfere with other necessary signs, or compromise safety or traffic flow.

In corridor signing projects the existing green background Memorial / Dedicated Highway signs shall be replaced with brown background signs.⁴⁶

EMERGENCY SERVICES SIGNS

Emergency service signs advise and direct the driver to facilities providing emergency service or assistance. Such facilities include hospitals providing emergency treatment and state, county, or local enforcement agencies. Emergency services signs are installed to benefit and assist motorists in emergency situations; they not intended for purposes of advertising or promoting a facility. The General Application for Guide Signing must be completed and submitted to the appropriate MDOT office.⁴⁷ For more details, see the Emergency Services Signs section of the Guidelines for Signing on State Trunklines.⁴⁸

⁴⁶ [Guidelines for Memorial Highway Signing](#)

⁴⁷ [Form 1501 – General Application for Guide Signing](#)

⁴⁸ [Guidelines for Signing on State Trunklines, page 25](#)

All Hospital signs shall have white legend on a blue background. The signs are listed below.

- Hospital Symbol sign (D9-2)
- Non-Freeway with Symbol, Name and Arrow (D9-2a, b, c)
- Freeway with Symbol, Name and NEXT RIGHT (E3-1(1.9))
- Freeway with Symbol, Name and EXIT XXX (E3-1(1.9a))
- Motorist Services signs (fingerboard) (E11-15c)

A "hospital highway zone" means a portion of state trunk line highway maintained by the state transportation department that has a posted speed limit of at least 50 miles per hour and has 2 or fewer lanes for travel in the same direction, traverses along property owned by a hospital, contains an ingress and egress point from hospital property, and extends not more than 1,000 feet beyond the boundary lines of hospital property in both directions in a municipality. The speed limit may be reduced by up to 10 miles per hour.⁴⁹

MDOT SUPPLIED SIGNS

On Department construction contracts, the following signs are to be fabricated by MDOT. The pay item used is "Installing MDOT Supplied Sign, Type _____." Use the appropriate sign panel and sign face designation from Section 919 of the Standard Specifications for Construction for Sign, Type _____:

- Welcome to Michigan/Pure Michigan
- Great Lakes Circle Tour
- Pure Michigan Byway
- Adopt A Highway, Adopt A Landscape, Adopt A Trail, Adopt An Area
- Click It Or Ticket (I13-1, I13-1a, b)
- State Police with symbol (I10-1)
- Sheriff with symbol (I10-2)

Unless otherwise noted, the construction contractor shall be responsible for transporting all signs designated as "Installing MDOT Supplied Sign, Type _____" from the Statewide Central Sign Shop.

OBJECT MARKERS

Objects to be marked are described in Part 2 of the MMUTCD. Type 3 markers are recommended for use on state trunkline highways.

Type 3 markers, by virtue of their inclined stripes directed toward the path that traffic should follow, are intended for use adjacent to the roadway and, when used in this fashion, fulfill two functions: 1) warn about the presence of an object and 2) direct traffic to a safe path.

⁴⁹ [MCL 257.627](#)

Detailed guidelines are given in the following “Guidelines for Use of Object Markers”.

1. Lateral Distance -

- a. On state trunkline highways, the lateral distance within which objects should be marked is the “usable” shoulder width up to a maximum of eight feet from the edge of the outer through traffic lane. The “usable” width of shoulder is that which can be used when a driver makes an emergency or parking stop. This criterion is applicable on both the right and left sides of the roadway.
- b. On two-way roadways more than four lanes, markers are not necessary for objects located on the driver’s left side.
- c. When there is a continuous vertical curb, objects do not normally need to be marked except where an isolated object is in target position and located within two feet of the curb face. Sections with low or sloped curbs (with or without paved shoulders) should be treated as roadways with shoulders.

2. Minimum Bottom Height -

The minimum height is four feet above the edge of the paved roadway. When the object marker warns of an object which by its nature requires a higher mounting, the mounting height may be increased.

3. Marker Location -

The marker should be positioned so that the nearest edge of the marker panel and that part of the object closest to the pavement are in line, except as noted in 5a.

4. Presence of Guardrail or Crash Cushion -

- a. Any object encroaching into the minimum lateral clear distance described in 1 (Lateral Distance) should be marked, regardless of the presence of a guardrail or a crash cushion.
- b. Guardrail approach terminals (Types 1, 2, and 3) and crash cushions shall be marked.

5. Other Applications -

- a. At transitions from a flush shoulder to a curbed section, a marker may be placed with its nearest edge two feet behind the face of curb at the beginning of the curbed section.
- b. Markers may be used at lane drops where there are fixed-objects to be marked.
- c. At locations where the Region/TSC Traffic and Safety Representative may judge a marker is necessary if the application reasonably conforms to the principles outlined in this guideline.

3. SIGN PLACEMENT

The total time needed to perceive and complete a reaction to a sign is the sum of the times necessary for Perception, Identification (understanding), Emotion (decision making), and Volition (execution of decision), and is called the PIEV time. The PIEV time can vary from several seconds for general signs to 6 seconds or more for signs requiring high road user judgment. Table 3, Minimum Advance Warning Sign Placement Distance, lists suggested warning sign placement distances for two conditions. This table is provided as an aid for determining warning sign location.

FREEWAY RAMPS

Freeway exit ramp signing is dependent upon the length of the exit ramp to a crossroad. The final location of any sign is based upon engineering judgment and topographical constraints. Use the suggested locations depicted in Table 11 and Table 12 as a guideline.

Table 11. Sign Placement on Freeway Exit Ramps

LENGTH (Of ramp)	SIGN TYPE	LOCATION (from crossroad centerline)
≥ 1500'	Motorist Services	200'
	Destination	350'
	Route Marker	500'
	Stop/Signal Ahead	750' 1 at each side of ramp
< 1500'	Motorist Services	200'
	Destination & Route Marker	350'
	Stop/Signal Ahead	500' (or 1/2 length of ramp) 1 at each side of ramp

Table 12. Required Freeway Exit Ramp Signs

SIGN TYPE	LOCATION
Wrong Way / Do Not Enter 50	<p>1 Wrong Way along with 1 Do Not Enter at crossroad on both sides of ramp turned 20° from crossroad to face possible wrong way vehicles</p> <p>1 Wrong Way along with 1 Do Not Enter at the target position of the ramp</p> <p>1 Wrong Way and 1 Do Not Enter behind both Stop/Signal Ahead signs</p> <p>1 Wrong Way placed behind the Exit Gore Sign</p> <p>Note: All Exit Ramp Wrong Way signs and Do Not Enter/Wrong Way signs use a 4' bottom height and shall be installed with red reflective strips on the posts</p>
One Way	2 signs placed back to back at the crossroad on both sides of a two-way road or 1 on each side of a one- way road
MAI number	Placed on the right Stop sign or Do Not Enter sign if intersection is not stop controlled and one on the Exit Gore Sign
Stop (stop control only)	1 on each side at the spring point of the curb

Motorist Services signs (fingerboards) on exit ramps shall be placed as follows:

BLUE	<p>GAS, DIESEL, FOOD, LODGING, CAMPING (if not covered by Logo signing)</p> <p>HOSPITAL</p> <p>STATE POLICE</p> <p>SHERIFF</p>
BROWN	<p>STATE PARK</p> <p>RECREATION AREA</p> <p>ANY OTHER BROWN SIGNS</p>
GREEN	<p>AIRPORT</p> <p>FAIRGROUNDS</p> <p>BUS STATION, TRAIN STATION</p> <p>ANY OTHER GREEN SIGNS</p>

The following govern application of overhead exit direction signs for Freeway:

1. At multi-exit interchanges, the sign should be located at the 2-foot point directly over the exiting lane for the first exit. At the same location and normally over the right-hand through lane, an overhead advance guide sign

[50 SIGN-120 – Roadside Sign Locations & Support Spacing](#)

for the second exit should be located. Only for those conditions where the through movement is not evident should a confirmatory message (Pull Thru sign) be used over the left lane(s) to guide motorists traveling through an interchange. Pull Thru signs shall not otherwise be used. In the interest of sign spreading, three signs on one structure are not recommended.

2. Overhead exit direction signs should be used for the second exit. If the second exit is beyond an underpass, the sign would ordinarily be mounted on the face of the overhead structure. When the freeway is on an overpass, the exit direction sign should be on a cantilever support over the exit lane at the gore point.

The order of freeway entrance ramp signing is essentially the same for all length of ramps. The R5-12a is the preferred sign that is placed at the beginning of an entrance ramp. There will be variances depending on judgment and topographical constraints.

Table 13. Sign Placement for All Freeway Entrance Ramps

SIGN TYPE	LOCATION
No Pedestrians Bicycles Motorcycles Under 125cc	50' from right spring point on ramp flare or 50' beyond 2' point on slip ramp.
Turn Prohibition	15' offset from edge of ramp pavement, 60' in advance of Merge sign.
Merge	17' from edge of freeway pavement, 6' from edge of paved shoulder.
MALI Number	On right support of Merge and Motor Vehicles Only signs.

Note: Offsets are noted if there is no guardrail or positive barrier. If guardrail is present, the minimum offset shall be 3' from back of guardrail posts.

Additional signs maybe necessary for freeway entrance and exit ramps, depending on the geometry of the ramp curve, for example:

- Chevrons and/or One Direction Large Arrow shall be used at any location where motorists must reduce their speed 15 mph or more below the posted speed limit of the mainline to negotiate a ramp curve.
- A Ramp Advisory Speed sign should be used at any location where motorists must reduce their speed 20 mph or more below the posted speed limit of the mainline to negotiate a ramp curve. Each curve on a ramp should be considered separately to determine if an advisory speed sign is needed for that curve. 'RAMP' is used when entering a limited access roadway from a surface street and 'EXIT' is used when leaving a limited access roadway, even if the exit goes

from freeway to freeway. Confirm a ramp advisory speed with the Region/TSC Traffic and Safety Representative.

- The use of an advisory speed on the exit gore sign is limited to an extreme reduction in speed of 40 mph or more below the posted speed limit of the mainline or a documented history of rollover or run-off-the-roadway crashes. The use of advisory speed limit signs on the exit gore is supplemental to the Exit or Ramp Advisory Speed signs.

CONVENTIONAL ROAD ADVANCE SIGNING TO INTERCHANGES

The signing sequence for an approach to a trunkline to trunkline non-freeway intersection shall follow Table 14. The advanced route turn assembly shall be used if the route does not continue straight through the intersection. When signing for destinations at intersections, refer to Guidelines for Signing on State Trunkline Highways - Designation of Destinations.⁵¹ Destinations should be the next major control city (or next minor control city if there is no major control city on route).

Table 14. Non-Freeway Approach for Trunkline to Trunkline Intersection

TYPE	NO TURN REQUIRED TO REMAIN ON ROUTE	TURN REQUIRED TO REMAIN ON ROUTE
Trunkline to Trunkline Intersection	Junction Assembly	Junction Assembly
	Directional Assembly	Advanced Route Turn Assembly
	D1 Series Guide Sign	D1 Series Guide Sign
	Far-side Directional Assembly (optional)	Directional Assembly
		Far-side Directional Assembly (optional)

The distances in Table 15 are approximate and require field verification. Adjustments to sign spacing should be made as necessary. When signing for destinations at interchanges, refer to Guidelines for Signing on State Trunkline Highways - Designation of Destinations. Destinations should be the next major control city (or next minor control city if there is no major control city on route).

⁵¹ [Guidelines for Signing on State Trunkline Highways](#)

Table 15. Sign Placement on Conventional Road Approach to Freeway Interchanges

CROSSROAD TYPE	SIGN TYPE	LOCATION
Major (One Lane) 52	Junction	1000' from Entrance Direction sign
	Destination	500' from Entrance Direction sign
	Entrance Direction (Trailblazer)	At 1 st entrance ramp
	Advance Route Turn Assembly	Before interchange
	Entrance Direction (Trailblazer)	At 2 nd entrance ramp
Major (Multi-Lane) 53 54	Junction	1000' from Entrance Direction sign
	Advance Direction (both directions of travel)	1 sign 800' from Entrance Direction sign (for 1 st entrance ramp) 1 sign 400' from previous Advance Direction (for 2 nd entrance ramp)
	Entrance Direction (Trailblazer)	At 1 st entrance ramp
	Advance Route Turn Assembly	Before interchange
	Entrance Direction (Trailblazer)	At 2 nd entrance ramp
Non-Freeway Trunkline (One Lane)	Junction	700' from 1 st Directional Assembly
	Directional Assembly	At 1 st entrance ramp
	Directional Assembly	At 2 nd entrance ramp

FREEWAY ADVANCE SIGNING TO INTERCHANGES

There are three interchange types:

Major - Freeway to freeway, multi-lane arterials, or state highways

Intermediate – Interchanges that are not covered under major or minor

Minor – Interchanges where local traffic is very light with exit volumes lower than 100 vehicles per day

All three interchange types utilize the Advance Guide and Exit Direction signs.

The Advance Guide and Exit Direction signs shall display the same destination information. Two destinations and the directional copy are as much as most drivers can comprehend. Not more than two destination names or street names should be shown. Directional copy, not exceeding three lines, may include symbols, route numbers, arrows, cardinal directions, and exit instruction. Destinations to the left are listed first followed by those to the right. All Exit Number (E1-5P), Left Exit Number (E1-5bP), and LEFT (E1-5aP) shall not be incorporated in the legend of an Advanced Guide, Exit

[52](#) Appendix A-2: [Typical Interchange Crossroad Signing](#)

[53](#) Appendix A-4: [Typical Interchange Crossroad Signing for Major Multi-Lane Partial Cloverleaf \(PARCLO\) Approach](#)

[54](#) Appendix A-5: [Typical Interchange Crossroad Signing for Major Multi-Lane Cloverleaf Approach](#)

Direction, or Preferential Lane Entrance Direction sign. Rather, these signs plaques shall be placed above and abutting the signs to which they apply, with their left or right edges aligned with those of the sign for left- and right-side movements, respectively. Road names are listed above city names. The location of these and other signs pertaining to the sign placement advance to freeway interchanges are depicted in Table 16.

Table 16. Sign Placement on Freeway Approach to Interchanges

SIGN TYPE	LOCATION
Advance Guide	Major Interchange - 2 miles and 1 mile in advance of exit * Intermediate and Minor Interchanges - 1 mile in advance of exit *
Exit Direction	At beginning of deceleration lane. - If distance from beginning of deceleration lane to gore is less than 300', place Exit Direction sign 100' – 200' in advance of the beginning of ramp taper. For overhead truss and cantilever installations, place the Exit Direction sign as close as possible to 2' point of exit gore. - When guardrail is necessary to protect motorists from the overhead sign structure, it shall be placed in accordance with the Roadside Design Manual.
Exit Gore	17' from edge of freeway pavement, 6' from edge of paved shoulder.
MALI Number	On right support of Exit Gore sign.

Note: Offsets are noted if there is no guardrail. If guardrail is present, the minimum offset shall be 3' from back of guardrail posts.

* Measure distance from 2' point of exit gore. When the recommended distance is not practicable, the distance shown should be to the nearest 1/4 mile. For interchanges spaced closer than the distance given, the first sign may be placed closer than the maximum but should not overlap the signing for the previous interchange.

In addition to the required guide signs listed in Table 16, there are supplemental guide signs that can be used in advance of interchanges. These ancillary signs, listed in Table 17, include Navigational Guide, Motorist Services / Emergency Services, Public Transportation, and Traffic generator signs, all of which should be placed between the Advance Guide and Exit Direction signs if there is sufficient longitudinal space available. The warrants established in the Guidelines for Signing on State Trunkline Highways shall be met for installation of supplemental guide signs.

Table 17. Advance Minor and Major Interchange Guide Signs

SIGN TYPE	LOCATION
Supplemental Guide – Navigational Guide Signs (destinations not shown on standard guide signing such as townships or cities) GREEN	Between Advance Guide and Exit Direction Signs if longitudinal space is available
Motorist Services / Emergency Services - BLUE	
Public Transportation – Airports, train stations, bus stations, vehicle ferry docks GREEN	
Traffic Generator Signs - Parks and Recreational Areas BROWN	
Traffic Generator Signs - Universities, Colleges, Arenas, Fairgrounds (with county name), Stadiums 1GREEN	

OVERHEAD ARROW-PER-LANE AND DIAGRAMMATIC GUIDE SIGNS

Overhead Arrow-per-Lane and Diagrammatic guide signs shall only be used for major and intermediate multi-lane exits that include an option lane. They shall not to be used for roadway splits or single lane exits, unless the freeway alignment warrants a diagrammatic sign to convey the uniqueness of the freeway alignment to the motorist.

The Overhead Arrow-per-Lane guide signs shall be used for all new installations and truss replacements on multi-lane exits that include an option lane. The sign located at the exit shall be located at the point where the exiting lanes begin to diverge from the through lanes and not at or near the theoretical gore. The Arrow-per-Lane guide signs shall consist of an arrow over every lane and show the EXIT and ONLY panels adjacent to the lane arrow that must exit.^{55 56}

Pull through signs may continue to be used if the truss is being retained at the gore location.

AFTER INTERCHANGES / ROUTE CHANGES / MAJOR HIGHWAY JUNCTIONS

The order of signing after an interchange, route change, or major highway junction is generally the same for both freeways and non-freeways; such as route marker, speed limit, and distance. For two lane freeways a KEEP RIGHT EXCEPT TO PASS sign is used. For freeways with three or more lanes an ALL TRUCKS USE RIGHT 2 LANES sign is used. The KEEP RIGHT EXCEPT TO PASS or ALL TRUCKS USE RIGHT 2 LANES sign can be omitted when the distance to the next interchange is one mile or less. The aforementioned signing order can be seen in further description in Table 18.

⁵⁵ Appendix A-5: [Typical Interchange Crossroad Signing for Major Multi-Lane Cloverleaf Approach](#)

⁵⁶ Appendix C: [Arrow Per Lane](#)

Table 18. Sign Placement after Freeway Interchanges and Non-Freeway Intersections

INTERCHANGE TYPE	SIGN TYPE	LOCATION	
		Freeway	Non-Freeway
All	Route Marker	500' (+/-) from end of ramp	Urban: 100' (+/-) from the center of the intersection Rural: 150' (+/-) from the center of the intersection
	Speed Limit	1500' (+/-) from end of ramp (also used at the end of a speed reduction zone)	Urban: 200' (+/-) from the center of the intersection Rural: 350' (+/-) from the center of the intersection
	Destination / Distance (used after a major interchange)	2500' (+/-) from end of ramp	Urban: 350' (+/-) from the center of the intersection Rural: 450' (+/-) from the center of the intersection
Two Lane Freeway	Keep Right Except to Pass	3500' (+/-) from end of ramp (Place on left side if possible)	N/A
Three or More Lane Freeway	All Trucks Use Right 2 Lanes	3500' (+/-) from end of ramp (Place on left side if possible)	N/A

JUNCTION ASSEMBLY SIGNS

A Junction assembly consists of a Junction auxiliary sign and a route sign. The route sign shall carry the number of the intersected or joined route. The Junction assembly shall be installed in advance of every intersection where a numbered non-freeway trunkline route is intersected or joined by another numbered non-freeway trunkline. In urban areas, it shall be installed in the block preceding the intersection, and in rural areas it shall be installed at least 400 feet in advance of the intersection. In rural areas, the minimum distance between the Destination sign and the Route Turn assembly shall be 200 feet, and the minimum distance between the Route Turn assembly and the Junction assembly shall be 200 feet.

In urban areas where speeds are low, the Junction assembly should not be installed more than 300 feet in advance of the intersection. Where prevailing speeds are high, greater spacing should be used.

Where two or more routes are to be indicated, a single Junction auxiliary sign may be used for the assembly and all route signs grouped in a single mounting, or a Combination Junction sign should be used.

As an incentive to local road agencies to consider trailblazer signing, the department will furnish route markers with the necessary supplemental panels for initial installations, as well as for replacement signs needed in the future. Local officials will install and maintain trailblazer assemblies at locations they deem necessary.

SPEED LIMIT SIGNS

The 24-inch by 30-inch Speed Limit (R2-1) sign shall be used for all single lane roadways. For multi-lane roadways a 30 inch by 36-inch sign shall be used. This does not preclude the case of a 36 inch by 48-inch size sign when engineering judgment indicates the larger size is needed for effectiveness.

1. Statewide: Signs displaying the statewide speed limit should be located beyond major state trunkline highway junctions, at the end of reduced speed zones, and at state trunkline highway entrances to the state. If none of the above conditions are met, then signs should be placed at least every ten miles.
2. Reduced Speed Zones Determined by Traffic Control Order: The first speed limit sign shall be placed at the point of change from one speed limit to another or as near there as possible. Additional sign locations within a zone should include positions just beyond major streets or highways if practical.

RESERVED PARKING FOR PERSONS WITH DISABILITIES

A RESERVED PARKING for person with disabilities (R7-8) sign shall be used for each parking space reserved for use by disabled persons per Section MCL 257.674(S)."

Where parking spaces that are reserved for persons with disabilities are designated to accommodate wheelchair vans, a VAN ACCESSIBLE (R7-8P) plaque shall be mounted below the R7-8 sign. The R7-8 sign shall have a green legend and border and a white wheelchair symbol on a blue square, all on a white background. The R7-8P plaque shall have a green legend and border on a white background.

STOP AHEAD AND SIGNAL AHEAD SIGNS

Unless noted otherwise within these guidelines, Stop Ahead signs should only be used when there is limited sight distance or significant crash history. A Stop Ahead sign should be a minimum of 36". The Stop Ahead and the stop sign it is being used with should be the same size.

Unless noted otherwise within these guidelines, Signal Ahead signs are to be used where there is limited sight distance, a significant crash history, or at the first signal approached when entering an urban area. Many existing Signal Ahead signs are obsolete because the urban area they are used for has expanded beyond the limits of the sign.

DIRECTIONAL CROSSOVERS AND DIVIDED HIGHWAYS

Medians 30 feet or less in width – do not require STOP/YIELD signs

Medians greater than 30 feet but less than 60 feet in width – use YIELD or STOP

Medians greater than 60 feet in width – use STOP sign

A route marker may not be placed above the optional guide sign. If both a route marker and a directional guide sign are desired, then the route portion must be integrated into the directional guide sign.^{57 58}

RAILROAD EXEMPT SIGNING

Railroad Exempt signs are to be used only at industrial or spur line railroad crossings.

This sign allows vehicles covered under Section MCL 257.669 to not stop at these types of railroad crossings. School busses are still required to stop at these locations according to Section MCL 257.1857.

NO ENGINE BRAKE SIGNS

The department does not allow NO ENGINE BRAKE or NO JAKE BRAKE signs on state trunklines. The reason for this position is the inability to enforce the sign. The Michigan State Police (MSP) has indicated that trucks are NOT prohibited from having, and therefore, using compression (engine) brakes. The MVC does address exhaust noise levels, which is not a compression (or engine) brake but is related to vehicle condition. It is MSP opinion that they cannot enforce these signs because the use of engine or Jake brakes is not in violation of State Law. Compression brakes that are working properly will be within tolerances for the state noise law. Any local ordinance prohibiting the use of engine or Jake brakes will be improper. It is almost impossible for an officer to prove in court that a driver was using his “engine brakes” and not simply letting off the accelerator.

A municipality can pass a noise ordinance identical to the MVC noise laws. Any noise ordinance that is different from the MVC noise law is not valid. Any sign that could legally be posted would have to indicate that NOISE LAWS STRICTLY ENFORCED (or similar language).

The Department will permit municipalities, within their jurisdiction, to install NOISE LAWS STRICTLY ENFORCED signs within Department right-of-way upon approval through the permit process. An “Individual Application and Permit” (Form 2205) must be completed by the municipality and returned to the appropriate MDOT Transportation Service Center (TSC) or Region Office for processing. The municipality requesting the signs shall be solely responsible for all work and costs associated with the sign fabrication, sign supports, installation and all future maintenance including removals. The location of the signs shall be approved by the Region Traffic and Safety

⁵⁷ Appendix B-13: [Signing for Directional Crossovers](#)

⁵⁸ Appendix B-18: [Signs at Divided Highway Intersections](#)

representative before fabrication begins. The Department retains the right for determining the final locations of all signs.

Through the permit for the local noise law sign, the Department has the authority to determine that the municipality is actually enforcing the local noise law statute.

Putting up signs seldom addresses the situation if enforcement is not possible. If enforcement was determined to be possible, the Department could entertain a request to have signing placed along state trunklines.

WEIGH STATION

The signing sequence for the entrance and exit to a weigh station is to be done according to the layouts in the Appendix.⁵⁹ Weigh station signing layouts at the scales differ by weigh station design and should be replaced “in kind.”

ROUNDABOUT

Signing on roundabout approaches through the roundabout exit should follow the signing sequence found in Appendix D.⁶⁰

MISCELLANEOUS SIGN PLACEMENT

The following tables have suggested sign placement for other miscellaneous signs for freeways only, Table 19, and non-freeway only, Table 20 and all types of roadways, Table 21.

⁵⁹ Appendix B-23: [Example Signing for Weigh Stations](#)

⁶⁰ Appendix D: [Roundabout Signing Guidelines](#)

Table 19. Miscellaneous Sign Placement on Freeways

SIGN TYPE	APPLICATION	LOCATION
Road Name	<p>For all crossroads without an exit for rural freeways.</p> <p>For urban freeways, road name signs may be used on all crossroads.</p>	<p>For crossroads over the freeway, connect sign to overpass, with the left edge of sign over right edge of right shoulder.</p> <p>For crossroads under the freeway, place in median before crossroad.</p>
Reference Location Signs (Enhanced Milepost Markers)	Required on all freeways	<p>D10-4 for rural freeways - 1 mile spacing</p> <p>D10-5 for urban freeways - 0.2 mile spacing</p> <p>+/- 50' from actual mile point</p> <p>Use 20' offset unless installed back to back in the median.</p> <p>All milepost markers shall have a green background.</p>
Authorized Vehicles Only	At median crossovers	<p>For medians 70' and greater in width, place each sign beyond the entrance of the crossover 30' from the edge of pavement at 45° to the freeway.</p> <p>For medians less than 70' wide, place 2 signs back to back in the center of the median at 45° to the freeway. Place the 2 signs on the west side of the crossover for east/west freeways and on the south side of the crossover for north/south freeways.</p>

Table 20. Miscellaneous Sign Placement on Non-Freeways

SIGN TYPE	APPLICATION	LOCATION
Parking Prohibition	Indicated by the TCO.	Urban – 100’ minimum, 300’ maximum Rural – 300’ minimum, 500’ maximum
Center Turn Lane	When roadway design depicts a 2-way left turn center lane.	-
Emergency Vehicles	Use with EMERGENCY SIGNAL AHEAD (W11-12p) supplemental plaque	In advance of all emergency-vehicle traffic signals
Prevention of Shoulder Driving	Region or TSC may authorize if shoulder driving is a problem	1 mile maximum spacing for rural, but closer spacing for urban settings with many intersections and driveways
Watch for Merging Traffic	Crossroads of tight diamond interchanges	In advance of crossroad bridge
Deer Crossing	Locations of known movements or at a location with a high deer crash history	As defined by the Region/TSC

Table 21. Miscellaneous Sign Placement on All Types of Roadways

SIGN TYPE	APPLICATION	LOCATION
Bridge Clearance	<p>All bridges with actual under clearance of 16' or less. (Bridge Design Manual, 7.01.08)</p> <p>Show dimensions 2" less than actual.</p> <p>The sign message SHALL NOT read more than: "15 FT 10 IN"</p>	<p>Bridge connection with left edge of sign over left edge of right lane.</p> <ul style="list-style-type: none"> - If a guide sign is located on the bridge over the right lane, the Bridge Clearance Sign should be located left of the guide sign. <p>The Bridge Clearance Sign should not be placed over a lane line.</p> <p>When 2 or more bridges are spaced at intervals of 300' or less, place the Bridge Clearance Sign only on the first structure.</p> <ul style="list-style-type: none"> - Use the lowest clearance to determine the dimension shown on the sign.
Bridge Ices Before Road	<p>All bridges and overpass structures 50' or more in length with posted speeds of 45 mph or higher. Where posted speeds are less 45 mph the sign is optional.</p> <ul style="list-style-type: none"> - For 3 or more lanes, dual signs may be used. 	<p>Per Table 3: Minimum Advance Warning Sign Placement Distance, Condition B, 0 mph.</p> <p>Where 2 or more structures are spaced 1,320' or less, 1 sign should be used prior to the first bridge, and the legend "BRIDGES ICE BEFORE ROAD" shall be used.</p>
Political Boundary	<p>City and county boundaries with township and sovereign tribal government boundaries upon request.</p>	<p>At or near point where boundary intersects the trunkline. The political entity to be signed must be shown on the state map.</p>
Landmark	<p>River, creek, and lake.</p>	<p>At or near point where landmark intersects the trunkline.</p>
Speed Reduction	<p>Should be used when there is a drop in speed of 15 mph or more.</p> <p>W3-5 is the preferred sign.</p>	<p>Per Table 3: Minimum Advance Warning Sign Placement Distance, Condition B, Decelerate to Indicated Advisory Speed.</p>
Flooded Roadway	<p>Used temporarily for pump and catch basin failures</p>	<p>Per Table 3: Minimum Advance Warning Sign Placement Distance, Condition B, 0 mph.</p>

INCIDENT MANAGEMENT ROUTE SIGNING

The proper placement of incident management route signing is crucial in the successful implementation of an Incident Management Plan for closure of a roadway due to an emergency. To ensure uniformity on diversion routes, the appearance of incident management route signing shall be in accordance with the current edition of the *Michigan Manual on Uniform Traffic Control Devices* (MMUTCD). All route sign

auxiliaries shall match the color combination of the route sign they supplement except the EMERGENCY auxiliary sign (M4-7f). The EMERGENCY auxiliary shall be a black legend and border on a fluorescent orange background sign mounted on top of the route assembly. See the current edition of the department's Standard Highway Signs book for a layout of this sign.

Placement of Incident Management Route signs can be done either through permanently installed or temporary signing. Details for the placement of incident management route signing can be found in Appendix E.⁶¹ For freeway diversion routes, permanently installed signing is recommended. For non-freeway, permanent signs should be considered on the following factors:

- Key routes
- High ADT roadways with documented repeated incidents
- Roadway utilizing long detours

Permanently installed fold down signs are not recommended due to the limited resources available to implement the plan and close the signs after the incident. In addition, maintenance issues regarding these types of signs do not lend them to be used as standard signing.

The location of Incident Management Route Signing shall follow the MMUTCD requirements in Part 2D except the confirming assembly. Additional information is also available in Appendix D of Traffic Sign Design Placement and Application Guidelines. Due to the occurrence of overlapping incident management routes, the motorist may be faced with a route turn and a straight through confirming message. Therefore, the confirming assembly should be placed 500 feet to 1,000 feet beyond the intersection to minimize motorist confusion at key decision points. The frequency of confirming assemblies should be limited to major intersection/key crossroads and at a frequency determined by the Region Traffic and Safety Representative to ensure continuity of the diversion route. Examples of Incident Management Route Signing are illustrated on page three, four and five of Appendix E. Refer to Region and TSC specific incident management route signing plans.

The Region Traffic and Safety Representative should discuss the proposed incident management route with the local road authority representatives, potentially affected by these routes, to ensure that they are agreeable to what is being proposed. Written permission should be obtained from the local agency to use non-trunkline roads in the proposed incident management route. Features, such as, but not limited to, the roadway geometrics, structure under clearances, and weight limits, should be considered when determining the proposed incident management route. Consideration should be given to developing unique routes for each direction of travel. Unique routes may improve traffic operations by minimizing potential left turning issues. The Region Traffic and Safety Representative should remain in contact on a regular basis with the local agency to determine if adjustments are needed to the incident management route because of local road construction.

⁶¹ Appendix E: [Incident Management Route Signing](#)

4. TRAFFIC CONTROL ORDERS AND DETERMINATIONS

Traffic Control Order (TCO) documents provide the legal basis for certain traffic regulations instituted on state trunkline highways. Such documents are made legal when co-signed by the directors of MDOT and MSP or their delegated signatory authority. Included in the regulations requiring TCOs are reduced speed zones and parking restrictions. Temporary traffic regulatory restrictions can also be instituted on a state trunkline highway when a temporary traffic control order is signed by MDOT. For more information on the Traffic Regulations Guidelines please contact MDOT signing unit or the local Traffic & Safety Engineer at the MDOT Region or TSC office.

TCOs are issued following a traffic engineering investigation conducted jointly by MDOT and MSP representatives. Although not required by law, a representative from the affected local agency should be invited to participate in the investigation.

For reduced speed zones governed by a TCO, the first speed limit sign shall be placed at the point of change from one speed limit to another or as near there as possible. Additional sign locations within a zone should include positions just beyond major streets or highways if practical. Signs should be placed approximately every quarter mile.

TCOs shall be checked as part of any signing design upgrade project and rescinded if they are no longer needed. TCOs can be found in the Traffic Control System (TCS) which is available on the MILogin for Workers website.⁶² At the unsignalized intersection of two or more state trunkline highways, or a state trunkline highway and a road under local jurisdiction, representatives from MDOT and MSP, acting jointly, will determine which traffic, if any, shall be given preference (right-of-way). Where a road under local jurisdiction meets a state trunkline highway the Michigan Vehicle code states that the local road shall stop for the trunkline. A stop determination is required to change this operation. A Traffic Control Determination (TCD) provides the legal basis for traffic preference when co-signed by the directors of MDOT and MSP or their delegated signatory authority. Placement of a stop, yield, or merging traffic sign shall be in accordance with the Michigan Vehicle Code⁶³ and the *Michigan Manual on Uniform Traffic Control Devices* (MMUTCD). For more information on TCOs, TCDs and other studies, please contact MDOT Signing Unit.

CHANGEABLE “YOUR SPEED” SIGNS

As a means to control speeds along select state trunklines, a local governmental agency may request, through the permit process, to deploy permanent changeable “YOUR SPEED” sign per each direction provided that the following criteria is met. Please note that the use of this device alone will not deter speeding. Other means such as law enforcement and/or properly set speed zones will minimize speeding. Portable

⁶² [MILogin for Workers](#)

⁶³ [Michigan Vehicle Code](#)

speed trailers, which can provide the same information as the changeable “YOUR SPEED” sign, should be encouraged prior to the installation of a permanent type sign.

Criteria:

1. If the most current speed study is older than two years, the local governmental agency must request a formal speed study from Michigan Department of Transportation (MDOT) and the Michigan State Police (MSP). MDOT/MSP will evaluate the existing speed limit.
 - If the speed zone appears to be inappropriate, then modify the existing speed limit through the speed study process. Contact MDOT Signing Unit for more information on speed studies.
 - If the speed zone is set properly, the local governmental agency may complete a permit application for the placement of a permanent changeable “YOUR SPEED” sign.
2. The local governmental agency is responsible for cost of materials, installation, maintenance, and all other associated costs. These signs must be placed on their own crash-worthy support. They are not to be placed with permanent MDOT traffic signs.
3. As part of the permit, the municipality shall agree to follow up speed studies conducted by the department at six and twelve months after the installation of the changeable “YOUR SPEED” sign. If the studies do not show a significant decrease in speed of more than 5 MPH, the department reserves the right to remove all changeable “YOUR SPEED” signs.
4. The installation is limited to one permanent changeable “YOUR SPEED” sign per each direction.

The design of the changeable “YOUR SPEED” sign shall meet the requirement of the current Michigan Manual on Uniform Traffic Control Devices. The permanent sign supports shall meet MDOT’s Sign Support Standards. The display of the “YOUR SPEED” sign should be limited to no higher than the 20 MPH above the posted speed limit to discourage motorists from attempting to post a high readout.

5. SCHOOL, PEDESTRIAN, AND NON-MOTORIZED SIGNING

Table 22. Standard School, Pedestrian, and Shared Use Sign Sizes

Standard Sign Sizes			
Sign/Plaque	Sign Code	Conventional Road	Oversized
School Advance Warning	S1-1	36 x 36	48 x 48
Bicycle Crossing	W11-1	36 x 36	48 x 48
Pedestrian Crossing	W11-2	36 x 36	48 x 48
Reduced Speed School Zone Ahead	S4-5, S4-5a	36 x 36	48 x 48
School Speed Limit XX When Flashing	S5-1	36 x 72	48 x 96
End School Zone	S5-2	36 x 48	36 x 48
Speed Limit (School Use)	R2-1	36 x 48	48 x 60
X:XX to X:XX AM X:XX to X:XX PM	S4-1P	36 x 18	48 x 24
School	S4-3P	36 x 12	48 x 16
When Flashing	S4-4P	36 x 18	48 x 24
Mon-Fri	S4-6P	36 x 18	48 x 24
XXX Ft	W16-2aP	36 x 18	48 x 24
Diagonal Arrow	W16-7P	36 x 18	48 x 24
Diagonal Arrow (optional size)	W16-7P	36 x 18	48 x 24
SHARE THE ROAD	W16-1P	18 x 24	24 x 30
Ahead	W16-9P	36 x 18	48 x 24
Shared Use Path	W11-15	36 x 36	48 x 48

- Notes: 1. Larger signs may be used when appropriate
2. Dimensions in inches are shown as width x height.

SCHOOL SIGNS

ADVANCE SIGNING

The School Advanced warning sign and AHEAD plaque should be used in advance of unexpected crossings.

The School Advanced warning sign and AHEAD plaque shall be used in advance of a designated crossing.

CROSSING SIGNING

The School Crossing sign and diagonal downward pointing arrow plaque shall be used at crossings of designated school crosswalks. The School Crossing sign and arrow plaque shall not be installed on approaches controlled by a STOP sign. The School Crossing sign and arrow plaque should not be installed at approaches controlled by a traffic signal.

SIGN COLOR AND PLACEMENT

All school area signs and plaques shall be fluorescent yellow-green.⁶⁴ Refer to School Area Traffic Control Guidelines for sign placement and more information.⁶⁵

REFLECTIVE STRIPS ON SIGN POSTS

All School Crossing signs shall be installed to have reflective sign strips on the posts. The color of the reflective sign strips shall be fluorescent yellow-green.

SCHOOL CROSSING ESTABLISHMENT

The establishment of a school crossing on state trunkline shall be based upon a traffic and engineering study conducted by the Department, in consultation with the superintendent of the school district.

SCHOOL BUS STOP WARNING SIGNS

School bus stops should not be signed. Section MCL 257.1855 sets distance requirements for bus stops to ensure the minimum stopping distance is available on non-freeways posted up to 55 mph. The act does not legally allow school bus stops with inadequate visibility to be in place. Department staff should coordinate with the school to relocate the stop for sight distance issues. School Bus Stop warning signs should not be used to address violators of the school bus flashing red lights.

PEDESTRIAN SIGNS

ADVANCE SIGNING

The warning sign and AHEAD plaque should be used in advance of unexpected crossings that are not school crossings.

The warning sign and AHEAD plaque shall be used in advance of a designated crossing.

CROSSING SIGNING

The warning sign and diagonal downward pointing arrow plaque shall be used at designated mid-block crossings. The warning sign and arrow plaque shall not be

⁶⁴ [MMUTCD: Figure 7B-1](#)

⁶⁵ [School Area Traffic Control Guidelines](#)

installed on approaches controlled by a STOP sign. The warning sign and arrow plaque should not be installed at approaches controlled by a traffic signal.

Yield Here To (Stop Here For) Pedestrians signs shall be used if yield (stop) lines are used in advance of a marked crosswalk that crosses an uncontrolled multilane approach. The signs shall only be used where the law (local regulation or ordinance) specifically requires that a driver yield. The legend LOCAL LAW may be displayed at the top of the signs if applicable.

Stop Here For Pedestrians signs shall be used if stop lines are used in advance of a marked crosswalk at a signalized trunkline intersection or on local streets where the law (local regulation or ordinance) specifically requires that a driver stop. The legend LOCAL LAW may be displayed at the top of the signs if applicable.

If yield (stop) lines and Yield Here To (Stop Here For) Pedestrians signs are used in advance of a crosswalk that crosses an uncontrolled multi-lane approach, they should be placed 20 to 50 feet in advance of the nearest crosswalk, and parking should be prohibited in the area between the yield (stop) line and the crosswalk.

Yield (stop) lines and Yield Here To (Stop Here For) Pedestrians signs should not be used in advance of crosswalks that cross an approach to or departure from a roundabout.

SIGN COLOR

The standard color for the warning sign and associated plaques is fluorescent yellow. The advance sign, the crossing sign, and the supplemental plaque color shall match.

REFLECTIVE STRIPS ON SIGN POSTS

All Pedestrian signs shall be installed to have reflective strips on the posts. The color of the reflective sign strips shall be fluorescent yellow.

TRAIL CROSSING SIGNS

ADVANCE SIGNING

The warning sign and AHEAD plaque should be used in advance of unexpected crossings.

The warning sign and AHEAD plaque shall be used in advance of a designated trail crossing.

CROSSING SIGNING

The warning sign and diagonal downward pointing arrow plaque shall be used at designated mid-block crossings. The warning sign and arrow plaque shall not be installed on approaches controlled by a STOP sign. The warning sign and arrow plaque should not be installed at approaches controlled by a traffic signal.

The Bicycle and Pedestrian symbol sign or TRAIL CROSSING sign may be used. The supplemental plaque, TRAIL X-ING, may be used with the bicycle and pedestrian symbol sign.

See ADVANCE SNOWMOBILE AND ALL TERRAIN VEHICLE (ATV) CROSSING SIGNS for snowmobile and ATV crossings.

SIGN COLOR

The standard color for the warning sign and associated plaques is fluorescent yellow. The advance sign, the crossing sign, and the supplemental plaque color shall match.

REFLECTIVE STRIPS ON SIGN POSTS

All TRAIL CROSSING or trail crossing symbol signs shall be installed to have reflective sign strips on the posts. The color of the reflective sign strips shall be fluorescent yellow.

BICYCLE SIGNS

ADVANCE SIGNING

The Bicycle warning sign and AHEAD plaque should be used in advance of unexpected crossings.

The Bicycle warning sign and AHEAD plaque shall be used in advance of a designated crossing.

CROSSING SIGNING

The Bicycle warning sign and diagonal downward pointing arrow plaque shall be used at crossings of designated bike trails. Such trails include Linear State Parks, Linear Rail Trails, and Multi-Use Trails. The Bicycle warning sign and arrow plaque shall not be installed on approaches controlled by a STOP sign. The Bicycle warning sign and arrow plaque should not be installed at approaches controlled by a traffic signal.

ON THE ROAD SIGNING

The Bicycle warning sign and SHARE THE ROAD plaque may be used together where the following conditions exist:

If:

- Significant bike use is observed (minimum of 100 cyclists in a season or bicycle activity four days of the week for three consecutive weeks) and
- Paved shoulders are 4-foot or less.

And two of the following conditions are present:

- On street parking is allowed and bikes are prohibited on sidewalks.

- Posted speed limit of 45 mph or greater.
- School or college area.
- ADT greater than 2,000 or commercial ADT greater than 300.
- Five or more bicycle crashes in a three-year period.
- Where vertical or horizontal sight distance is limited.
- Where bike lanes terminate offering bicyclists no alternative route.
- Guardrail in place (no escape route):
 1. Face of Rail to Edge Line is less than 6 feet.
 2. Five or more Guardrail runs in a mile.
 3. Guardrail runs longer than 1,000 feet.

PLACEMENT INFORMATION

The Bicycle warning sign and SHARE THE ROAD plaque should be placed where the above condition begins, after major intersections, and at one-mile intervals.

PROHIBITIONS

The Bicycle warning sign and SHARE THE ROAD plaque are not permitted at the following locations:

- On Freeways or ramps.
- On routes with 6-foot paved shoulders or wider unless the designated bike lane ends at the beginning of a 6-foot-wide paved shoulder.
- On routes where a separate path is available.

SIGN COLOR

The standard color for the Bicycle warning sign and associated plaques is fluorescent yellow. The advance sign, the crossing sign, and the supplemental plaque color shall match.

REFLECTIVE STRIPS ON SIGN POSTS

All bicycle symbol signs shall be installed to have reflective sign strips on the posts. The color of the reflective sign strips shall be fluorescent yellow.

6. LOGOS, TODS, & ADOPT-A-HIGHWAY

SPECIFIC SERVICE (LOGO) SIGNING

The Specific Service (Logo) Signing Program provides for installation and maintenance of logo signs at non-metropolitan interchanges on the freeway system.⁶⁶ The logo signs are erected to provide identification and directional information to the traveling public for eligible business establishments offering services for gas, food, lodging, camping, pharmacies, and attractions. The business can provide this information by contracting to have a logo sign placed on the specific service signs structure. The specific service sign structures are to be placed in the order of attractions, pharmacy, camping, lodging, food, and gas as observed in the direction of travel. The Department has contracted with Michigan Logos, Inc. to administer the Specific Service (Logo) Signing Program for the State of Michigan.⁶⁷ This program replaces the generic symbols formerly furnished by the Department.

Mainline logo signs are placed along the freeway within one mile of the exit. Ramp signs, which can be placed on the right or left side, indicate the direction and mileage to the service. Trailblazing signs, when required, must be approved by the roadway agency having jurisdiction over the affected roadway before the logo sign can be placed on the state freeway.

Do not replace or remove logo signing. These signs shall be shown as retained on the plans and can only be relocated by Michigan Logos, Inc.

TOURIST ORIENTED DIRECTIONAL SIGNS (TODS)

TODS is a sign program which provides identification and directional information for tourist oriented activities off of the state rural non-freeway system.⁶⁸ A tourist oriented activity is any lawful cultural, historical, recreational, or education activity which is attended annually by 2,000 or more persons and for which a major portion of its income or visitors are derived during the normal business season from motorists not residing in the immediate area. As defined by law, the immediate area is within ten miles of the activity. In the Upper Peninsula, the immediate area is within fifteen miles of the activity. The Department has contracted with Michigan Logos, Inc. to administer the TODS program.⁶⁹

TODS signs are placed along non-freeways within one-half mile of an intersection with another state or local rural non-freeway. Trailblazer signs, when required, must be approved by the roadway agency having jurisdiction over the affected roadway. When required on local roads, these signs must be approved by the agency before the TODS sign can be placed on the state non-freeway.

⁶⁶ [MMUTCD Section 2J.01](#), page 312

⁶⁷ [Michigan Specific Service \(Logo\) Signing Program](#)

⁶⁸ [MMUTCD Section 2K.01](#), page 320

⁶⁹ [Tourist Oriented Directional Signs \(TODS\)](#)

Do not replace or remove TODS signing. These signs shall be shown as retained on the plans and can only be relocated by Michigan Logos, Inc.

ADOPT-A-HIGHWAY SIGN REPLACEMENT

The following guidelines shall be used when Adopt-A-Highway signs are included in Department corridor signing projects:

1. Upgrade sign supports to current Department Sign Support Standards.
2. Relocate sign, if necessary, to ensure appropriate sign spacing along roadway.
3. Adopt-A-Highway signs shall not be placed at key decision points where a driver's attention is more appropriately focused on traffic control devices, roadway geometry, or traffic conditions. These locations include, but are not limited to exit and entrance ramps, intersections controlled by traffic signals or by stop or yield signs, railroad grade crossings, and areas of limited sight distance.
4. The height to the bottom of the sponsor plaque should be located at a height of six feet.
5. Replace parent sign if it is beyond its expected 15-year life. Replacement of Adopt-A-Highway signs will be paid for as Installing MDOT Supplied Sign, Type III.
6. Verify the current sponsor information with the Transportation Service Center. Replace sponsor plaque if information needs to be revised or if the plaque is beyond its expected 15-year life. Replacement of Adopt-A-Highway sponsor plaques will be paid for as Installing MDOT Supplied Sign, Type III.
7. If there is no sponsor at the time of the contract, erect **ONLY** the parent sign. The use of signs to advertise the program is not permitted per the *Michigan Manual on Uniform Traffic Control Devices*.
8. All costs associated with replacement of Adopt-A-Highway signs in corridor signing projects will be assumed by the project.
9. An overlay with the word Available shall be placed over the sponsor information if a sponsor ends its sponsorship.
10. All MDOT Adopt-A-Highway bottom panel signs called for removal in a project shall be removed and then returned to MDOT at no additional charge to the department. All MDOT Adopt-A-Highway top panel signs called for removal in a project will not be returned to MDOT.

7. OVERHEAD SIGN STRUCTURES

Specifications for the design and construction of structural supports for signs have been standardized by the American Association of State Highway and Transportation Officials (AASHTO). Bridges in sufficient condition (bridge mounted) can often serve for the support of bridge mounted signs and might in some cases be the only practical location that will provide adequate viewing distance. Use of these structures as sign supports will eliminate the need for additional sign supports and foundations along the roadside.

Before overhead signs are recommended for installation or replacement, a careful analysis is required to determine if roadside signs might serve traffic needs. Clear zone guidelines must be considered when evaluating the need for overhead signing. Factors justifying the installation of overhead signs are given in Structure Criteria.

USE

Signs placed directly over the travel lanes to which they apply can be of assistance in increasing communications with the driver. Overhead signs should be used on freeways, at locations where some degree of lane-use control is desirable, and at locations where space is not available at the roadside.⁷⁰ Their principal applications are on multilane heavily traveled highways. Overhead signs are generally used:

1. Where the message is applicable to a particular lane(s) over which the sign is placed and where lane use can be made significantly more effective.
2. Where traffic or roadway conditions are such that an overhead mounting is necessary for adequate visibility (e.g., vertical or horizontal curvature, closely spaced interchanges, three or more through lanes in one direction etc.).
3. At, or just in advance of, a divergence from a heavily traveled roadway (e.g., at a ramp exit where the roadway becomes wider, and a sign on the right side is usually not in the line of sight for the driver).
4. Where there is no space for signs at the side of the roadway (e.g., where narrow right-of-way does not provide adequate width for a sign installation).
5. Where ground-mounted placement would create an undue roadside hazard.
6. Where, because of hazardous conditions, particularly effective guidance is needed for the unfamiliar driver.
7. Before placing a W-series sign in an overhead position, consider the upstream configuration of signing. Consider placement of the W-series for ground mount placement per Table 3. If ground mounting of the W-series cannot be done at an upstream location, please contact the central office traffic signing unit at 517-335-2624.

⁷⁰ Appendix C: [Arrow Per Lane](#)

STRUCTURE CRITERIA

The operational requirements of our present highway system are such that overhead signs will have value at many locations. The factors justifying the erection of overhead sign displays are not definable in specific numerical terms, but the following conditions require serious consideration:

1. Exit only lanes
2. Left exit ramps
3. Traffic volume at or near capacity
4. Complex interchange design (double exits)
5. Three or more lanes in each direction
6. Restricted sight distance (ramp deceleration lanes located over crest vertical curves)
7. Closely spaced interchanges
8. Multi-lane exits
9. Large percentage of trucks
10. Street lighting background
11. High speed traffic
12. Consistency of sign message location through a series of interchanges
13. Insufficient space for ground mounted signs
14. Junction of an Interstate route with another freeway (lane assignments)
15. Deficient Bridges⁷¹ for bridge mounted signs

Other than what is a standard in the MMUTCD, the existence of any one or more of the factors does not automatically justify the use of overhead signs. Some of the factors listed above can be made less critical by close coordination between design and operation.

Overhead signing is required per the MMUTCD for the following situations/sign types:

1. Overhead Arrow per Lane/Diagrammatic Guide Signs at Major Interchanges
2. Pull Through Signs
3. Interchange Lane Drops
4. Interchange Sequence Signs in the Median
5. Freeway to Freeway – 1 Mile Advance and at theoretical gore
6. Cloverleaf – At theoretical gore for first exit ramp and Advance Guide sign for second ramp

If a Region/TSC Traffic and Safety Representative desires to pursue overhead signing for a specific location(s), a joint field investigation by Lansing Traffic Signing and Region/TSC personnel should be conducted to determine final signing requirements.

⁷¹ [MDOT Highway Bridge Safety Website](#)

PRIORITY

If it has been determined that an overhead sign installation is required, the following order of priority for support should be considered. Please note on urban freeways where overhead crossings are closely spaced it is desirable to place signs on bridges to enhance safety and for economic benefit. Under some circumstances, the use of bridge structures as sign supports might be the only practical solution that will provide adequate viewing distance. Most bridge mounted sign connections are significantly lower in cost than standalone overhead sign structures. Design and placement of a truss or cantilever in front of a bridge structure is least desirable but are options based on deficient bridge conditions.

DESIGN

The size and number of guide signs are the principal factors that determine the type of overhead sign structures to choose from. The following is list of common structures for consideration based on in-depth field review and location availability:

Overhead Lane Assignment	TWO-WAY LEFT TURN, BEGIN/END CENTER LANE Signs (Non-Freeway).
Truss	Used for more than one sign per location. Use Type E (Type C and D for special conditions, ex. underground utilities).
Bridge	Used if there is a suitable structure available in approximate location for sign replacement. The primary selection factor is the type of beam and the material constructed from. The following bridge beams call for specific bridge sign connection types for upgrades. ⁷² Beams- Steel Sign-800 series (Type B) Sign-820 series (Types F & G) Sign-830 series (Types H, I & J) Beams- Concrete Sign-800 series (Types A1 & A2) Sign-850 series (Types K, L & M) Sign-870 series (Types O, P & Q) Sign-880 series (Types R, S & T) Sign-890 series (Types U, V & W)

⁷² Appendix A-11: [Bridge Sign Connection Cheat Sheet](#)

The principal design application for bridge sign connection listed above is for replacement of an existing support for a larger bridge sign connection per new sign size. New built bridges having beams greater than 36 inches are excellent structures to consider new style bridge sign connections.

Existing steel beam bridges having bridge sign connections should be carefully inspected for maintenance replacement. Ideally, the beam has been determined sufficient to receive a new set of bolt holes to replace the existing bridge sign connection. In some cases, a new set of bolt holes isn't desirable per MDOT policy specifically for railroad and pedestrian structures. The existing bridge sign connections on these structures should be replaced utilizing existing bolt holes. The following bridge sign connections are for Maintenance purposes only:

4 Bolt Pattern

Sign-821 series (Types C & D)

Sign-831 series (Types E & F)

6 Bolt Pattern

Sign-898 series (Types C & D)

Sign-899 series (Types E & F)

Existing Concrete beam bridges having bridge sign connections should be carefully inspected. Non-Standard concrete bridge sign connections should be replaced with the current standard designed to utilize concrete railing and fascia in sufficient condition. Where a concrete bridge is being considered for a bridge sign connection, the concrete surface should be free of defects, deformation, missing chunks or other undesirable characteristics. In some circumstances, the existing bridge sign connection may be retained. The use of existing concrete holes is not permitted.

Cantilever

Used when previous alternatives are not applicable. Use Type E, (Type J for special conditions, ex. poor soil conditions, multiple signs needed, but truss is not possible, or other adverse conditions).

APPENDIX A
Figures & Tables

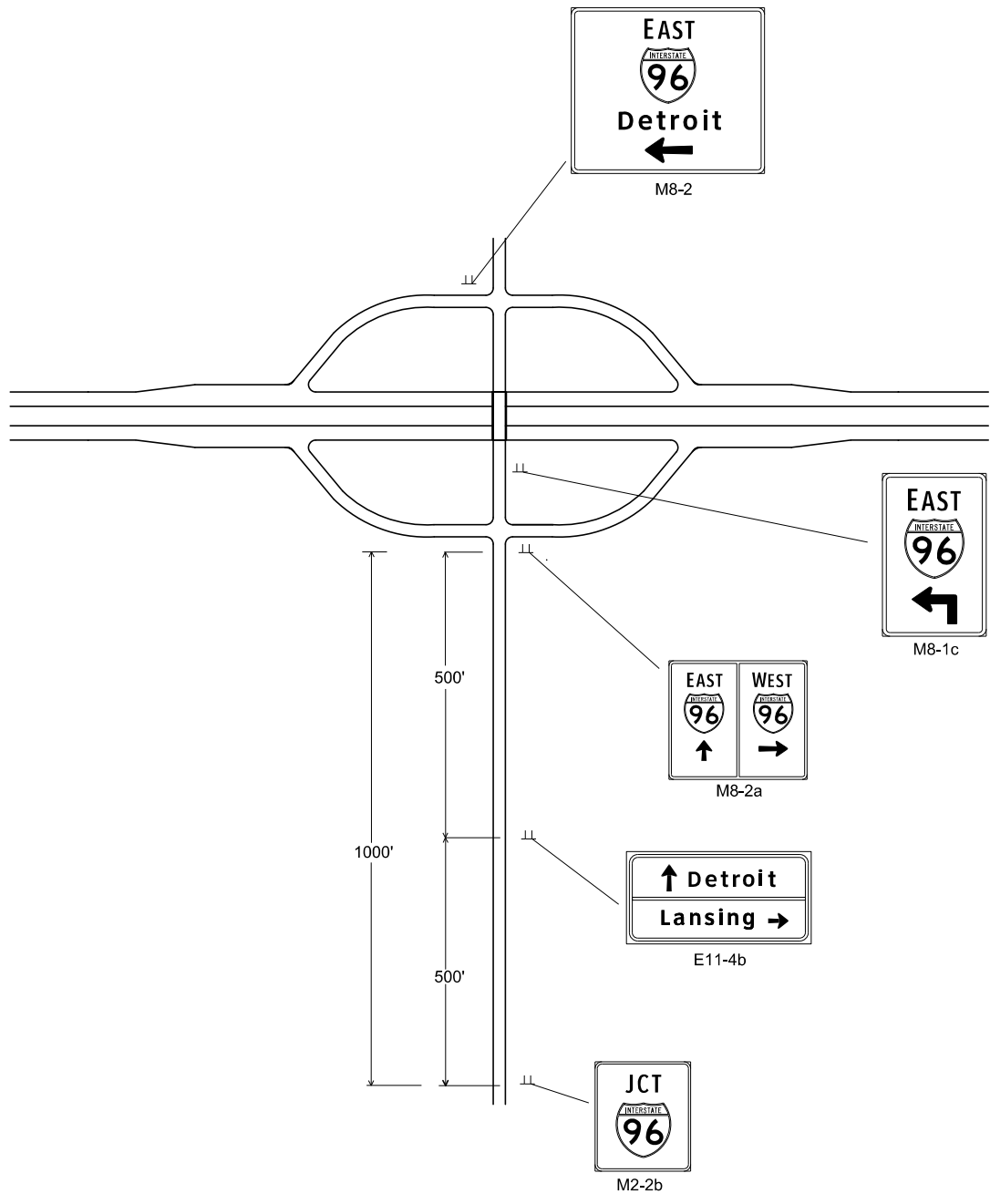

All signs are ground mounted unless as otherwise indicated.



TRAFFIC AND SAFETY

Interchange Crossroad Guide Signing for One Direction, One-Lane Approach

DRAWN BY: QHN
CHECKED BY: AJU

07/19/2022
PLAN DATE:

A-2

FILE: mdot_tsdpag_appendix_a.dgn

REV.

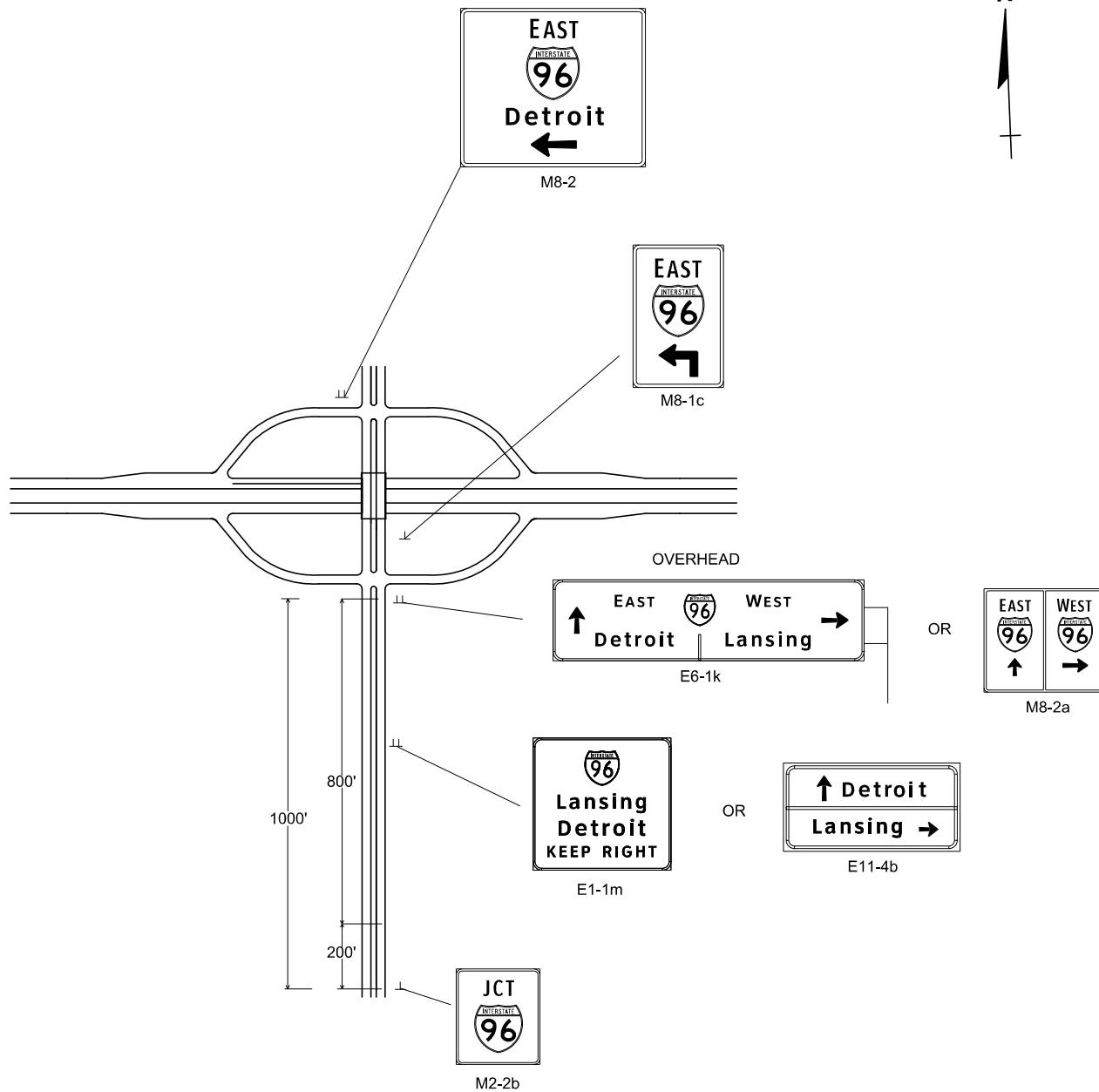

TRAFFIC AND SAFETY

Interchange Crossroad Guide Signing for One Direction, Multi-Lane Approach

DRAWN BY: QHN

07/19/2022

CHECKED BY: AJU

PLAN DATE:

A-3

FILE: mdot_tsdpag_appendix_a.dgn

REV.

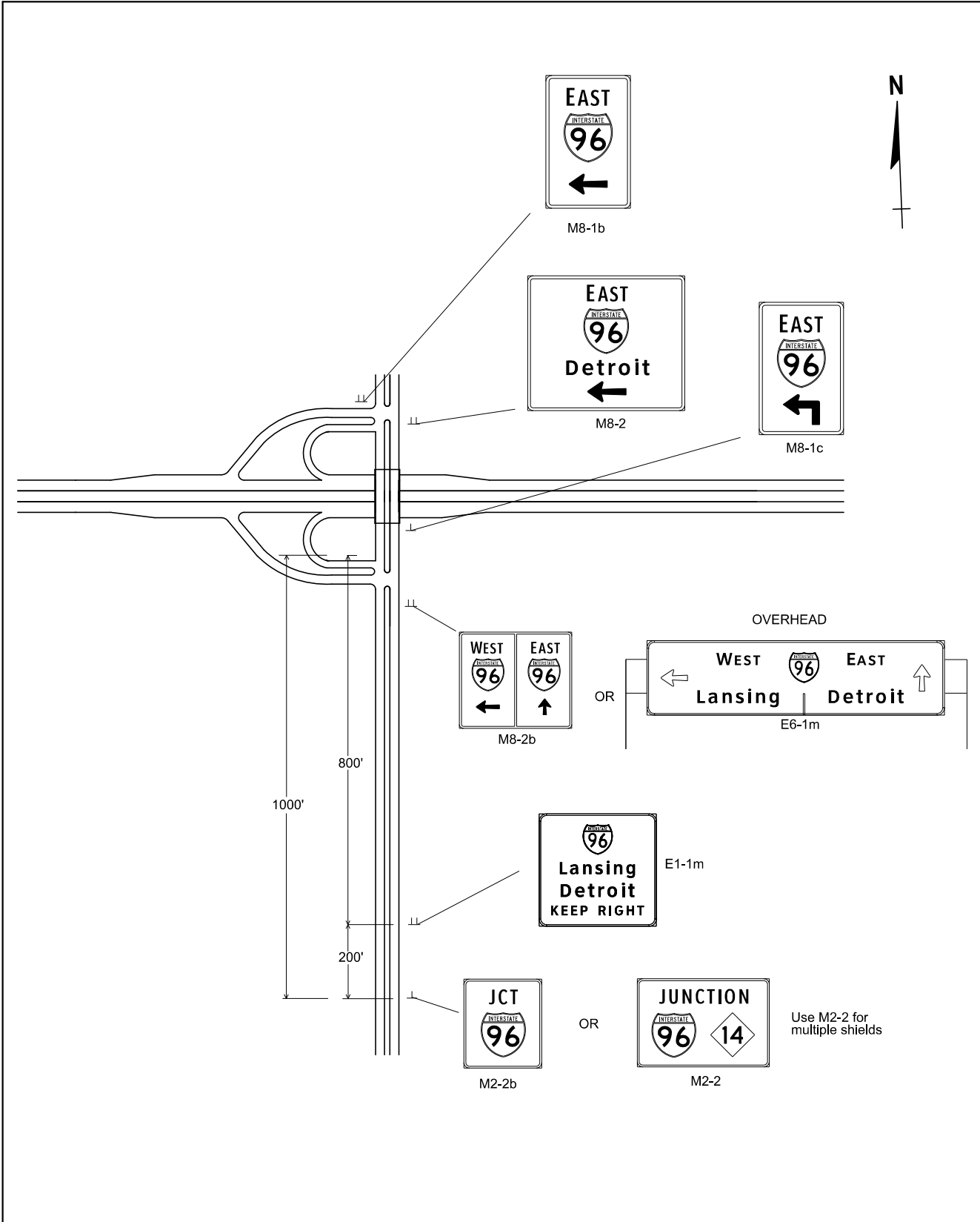

	Partial Cloverleaf Interchange Crossroad Guide Signing for One Direction, Multi-Lane Approach		
	TRAFFIC AND SAFETY	DRAWN BY: QHN CHECKED BY: AJU	07/19/2022 PLAN DATE:
FILE: mdot_tsdpag_appendix_a.dgn			REV.



E6-1f

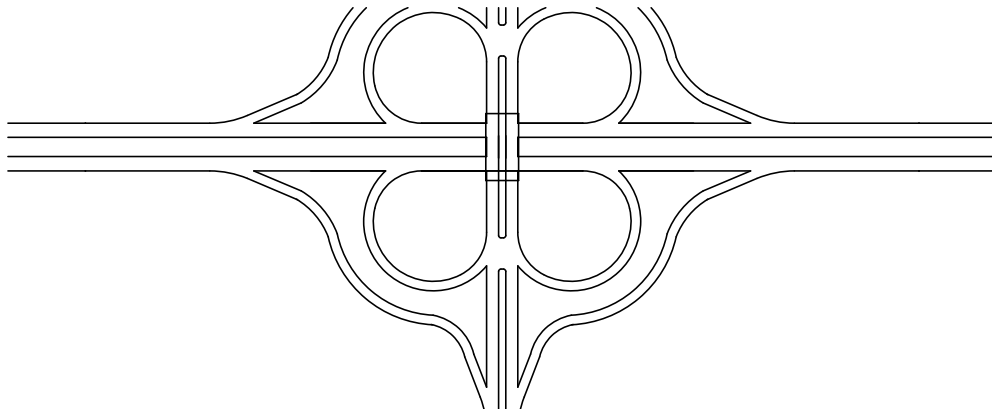

E1-1j



E6-1f

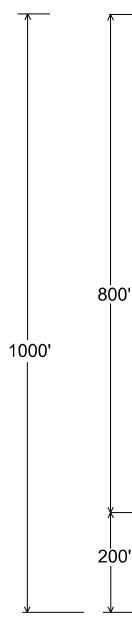

E1-1m

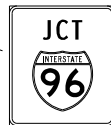

M2-2b

OR

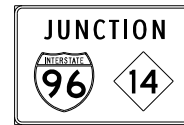

M2-2

Where trunkline is a dual shield designation, use M2-2. All subsequent signs shall carry dual shields as designated.



TRAFFIC AND SAFETY

Cloverleaf Interchange Crossroad
Guide Signing for One Direction,
Multi-Lane Approach

DRAWN BY: QHN
CHECKED BY: AJU

07/19/2022
PLAN DATE:

A-5

FILE: mdot_tsdpag_appendix_a.dgn

REV.

Retroreflective Sign Sheeting Material Guidelines

Table 3. Sign Type and Corresponding Material Type

SIGN CATEGORY	MATERIAL TYPE
Yellow Warning Signs: - W Series (Non School Related) - E11-1, E13-1, E13-2 - OM-1, OM-2, OM-3	ASTM Type IX Fluorescent Yellow
School Signs - S1-1, S4-3P, S4-5, S4-5a, S5-1 - W16-2P, W16-2aP, W16-7P, W16-9P (when used with conjunction with school signs)	ASTM Type IX Fluorescent Yellow-Green
Freeway and Non-Freeway Guide Signs (Including M8 Series) - White Legends, Borders, and Arrows - Background	ASTMY Type XI White ASTMY Type IV Green, Brown, or Blue
Regulatory Signs	ASTM Type IV
Route Markers	ASTM IX

Sign Panel and Sign Face Guide

Table 4. Sign Panel Type and Corresponding Material Type

SIGN PANEL TYPE	MATERIAL TYPE
I	Aluminum Extruded Sections
II	Plywood (0.625")
III	Aluminum Sheet (0.080")
IV	Aluminum Sheet Overlay (0.040")
V	Aluminum Sheet (0.125")

Table 5. Sign Face Type and Corresponding Reflectivity

SIGN FACE TYPE	BACKGROUND	LEGEND
A	Reflectorized	Reflectorized
B	Reflectorized	Non-Reflectorized
	Non-Reflectorized	Reflectorized

NOTE:

Signs 36 inches x 36 inches or smaller shall be nominal 0.080 inch aluminum sheet (Type III).
Signs 48 inches x 24 inches in size may be plywood (Type II).

Signs larger than 36 inches x 36 inches and up to and including 120 inches x 48 inches shall be plywood (Type II).

Signs wider than 120 inches or higher than 48 inches shall be aluminum extrusion (Type I) Sign panels.

All 48 inches x 48 inches signs shall be nominal 0.125 inch aluminum sheet (Type V).

For sign overlays, use nominal 0.040 inch aluminum sheet (Type IV).

Rounding of corners is not required for plywood (Type II) or aluminum extrusion (Type I) signs panels.

Flexible roll-up signs may be used in accordance to the 2012 standard specifications for construction.

Table 6. Freeway Clearview Letter Sizes

1. Advance Guide and Exit Direction (White legend on Green background)	
Freeway Expressway	16"/12" 5-W 13.33"/10" 5-W
2. Supplemental Navigational (White legend on Green background)	
Freeway	13.33"/10" 5-W
3. Emergency Service (White legend on Blue background)	
Hospital <ul style="list-style-type: none"> • Ramp Service Signs (E11-15) • Advance Service Signs (D9-18) Law Enforcement <ul style="list-style-type: none"> • Ramp Service Signs (E11-15) • Advance Police-Sheriff Signs (E11-2) 	5" 2-W 10" 3-W and/or 24" Symbol 5" 2-W 8"/6" 5-W
4. Motorist Services (White legend on Blue background)	
Gas, Food, Lodging, Camping <ul style="list-style-type: none"> • Ramp Service Signs (E11-15) • Advance Service Signs (D9-18) 	5" 2-W 10" 3-W and/or 24" Symbol
5. Public Transportation (White legend on Green background)	
Airports <ul style="list-style-type: none"> • Ramp Service Signs (E11-15) • Advance Airport Signs (E3-1 (1.4)) • Advance Int'l Airport Signs (E3-1 (1.6)) Train and Bus Stations <ul style="list-style-type: none"> • Ramp Service Signs (E11-15) • Advance Train-Bus Signs (E3-1 (1.5)) 	5" 2-W 8"/6" 5-W 13.33"/10" 5-W 5" 2-W 8"/6" 5-W
6. Traffic Generator	
Universities and Colleges (E3-1 (1.8), Wh/Gr) Parks and Recreational Areas (E3-1, Wh/Br) Arenas, Fairgrounds, Stadiums (E3-1 (1.7), Wh/Gr)	8"/6" 5-W 8"/6" 5-W 8"/6" 5-W
7. General Information (White legend on Green background)	
County, City, Township Boundary (E11-5, E11-6) Rivers and Lakes (E11-7, E11-8) Street Name (E11-3)	8"/6" 5-W 8"/6" 5-W 8"/6" 5-W

Table 7. Non-Freeway Clearview Letter Sizes

1. Navigational Guide Signs (White legend on Green background)	
55 mph to 40 mph, posted	7" 3-W
35 mph or less, posted	5" 3-W
2. Emergency Service (White legend on Blue background)	
Hospital	Symbol
Law Enforcement	5" 2-W
3. Motorist Services (White legend on Blue background)	
Gas, Food, Lodging, Camping	Symbol
4. Public Transportation (White legend on Green background)	
Airports (I12-1, I12-2, I12-3)	5" 2-W or Symbol
Train and Bus Stations (I12-1, I12-2, I12-3)	5" 2-W or Symbol
5. Traffic Generator	
Universities and Colleges (I12-1, I12-2, I12-3)	5" 2-W
Parks and Recreational Areas	
• 55 mph to 40 mph, posted (D7-1, D7-2)	6" 3-W or Symbol
• 35 mph or less, posted (D7-1)	4" 3-W or Symbol
Arenas, Fairgrounds, Stadiums (I12-2, -2, -3)	5" 2-W
6. General Information (White legend on Green background)	
County and Township Boundary (I2-2)	4" 2-W
City and Village Boundary (I2-3)	7" 3-W
Rivers and Lakes (I13-1, I13-2)	4" 2-W
Street Name (D3-2)	
• 55 mph to 40 mph, posted	7" 3-W
• 35 mph or less, posted	5" 3-W

Deviation from these freeway standard letter sizes may be required. Refer to the Michigan Standard Highway Signs book for the appropriate layout letter size for guide signs. Below is the Clearview font conversation from the SHS Standard Alphabet:

SHS Standard Alphabet	Clearview "W"
Series B	Clearview 1-W
Series C	Clearview 2-W
Series D	Clearview 3-W
Series E	Clearview 4-W
Series E-Modified	Clearview 5-W and Clearview 5-W-R*
Series F	Clearview 6-W

- Clearview 5-W-R has tighter letter space than 5-W and is designed for replacement of overhead guide signs when the 5-W legend is too wide for the specific application.

Process for Invoicing and Reimbursement

This process allows the Department to invoice and receive payment for a sign installation from an outside party. Signs covered under the following must be unplanned sign installations. They must be in the same fiscal year, they cannot carry over.

1. Prepare the estimate for fabrication and installation (all costs, including fringes, shipping, etc.). Do not fabricate or install the sign at this point. Also, do not accept payment from the outside party.
2. Send to Region financial analyst. They will work with Finance to create an invoice. Financial analyst, please refer to Guidance Document 10153. A memo with a completed TWA form (form 1515) is sufficient. Finance will invoice the party requesting the sign.
3. When the payment is received by Finance, they will add the money to the coding that you provided them with on the TWA form (probably region maintenance coding).
4. Once you are contacted by Region Finance, you may fabricate and install the sign and charge to the same coding that was originally submitted. Do not fabricate or install before the funds are added to the designated account.

Bridge Sign Connection Cheat Sheet

	Pay Item	Description	Standard	Width	Height	Angle	# of Columns	Comments	Connection Surface
	8100020	Bridge Sign Connection, Bolt Replacement							
Concrete Surface	8100031	Bridge Sign Connection, Conc, Type A1	800	6 - 12	0 - 2.5	0 - 40	n/a		Deck Fascia
	8100032	Bridge Sign Connection, Conc, Type A2	800	6 - 12	0 - 2.5	0 - 40	n/a		T-Beams or Conc Barriers
	8100033	Bridge Sign Connection, Conc, Type C	810	0 - 22	0 - 20	0 - 40	2 Columns		Prestressed Conc I-beam
	8100034	Bridge Sign Connection, Conc, Type D	810	0 - 40	0 - 20	0 - 40	3 columns		Prestressed Conc I-beam
	8100035	Bridge Sign Connection, Conc, Type E	810	0 - 40	0 - 20	0 - 40	4 columns		Prestressed Conc I-beam
	8100037	Bridge Sign Connection, Conc, Type K	850	0 - 22	0 - 20	0 - 40	2 Columns	Area<190	Conc T-beam
	8100038	Bridge Sign Connection, Conc, Type L	850	0 - 40	0 - 20	0 - 40	3 columns	Area<300	Conc T-beam
	8100039	Bridge Sign Connection, Conc, Type M	850	0 - 40	0 - 20	0 - 40	4 columns	Area<370	Conc T-beam
	8100040	Bridge Sign Connection, Conc, Type O	870	0 - 22	0 - 10	0 - 40	2 Columns	Area<200	Prestressed I-beam
	8100041	Bridge Sign Connection, Conc, Type P	870	0 - 40	0 - 10	0 - 40	3 columns	Area<300	Prestressed I-beam
	8100042	Bridge Sign Connection, Conc, Type Q	870	0 - 40	0 - 10	0 - 40	4 columns	Area<380	Prestressed I-beam
	8100043	Bridge Sign Connection, Conc, Type R	880	0 - 22	0 - 10	0 - 40	2 Columns	Area<200	side by side box beam
	8100044	Bridge Sign Connection, Conc, Type S	880	0 - 40	0 - 10	0 - 40	3 columns	Area<340	side by side box beam
	8100045	Bridge Sign Connection, Conc, Type T	880	0 - 40	0 - 10	0 - 40	4 columns	Area<380	side by side box beam
8100046	Bridge Sign Connection, Conc, Type U	890	0 - 22	0 - 10	0 - 40	2 Columns	Area<200	spread box beam	
8100047	Bridge Sign Connection, Conc, Type V	890	0 - 40	0 - 10	0 - 40	3 columns	Area<300	spread box beam	
8100048	Bridge Sign Connection, Conc, Type W	890	0 - 40	0 - 10	0 - 40	4 columns	Area<380	spread box beam	
Steel Surface	8100061	Bridge Sign Connection, Steel, Type B	800	6 - 12	0 - 2.5	0	n/a		
	8100062	Bridge Sign Connection, Steel, Type C (old type)	821	0 - 22	0 - 20	0	2 Columns	4 bolts on top	
	8100063	Bridge Sign Connection, Steel, Type D (old type)	821	0 - 40	0 - 20	0	3 columns	4 bolts on top	
	8100062	Bridge Sign Connection, Steel, Type C (old type)	898	0 - 22	0 - 20	0	2 Columns	6 bolts on top	
	8100063	Bridge Sign Connection, Steel, Type D (old type)	898	0 - 40	0 - 20	0	3 columns	6 bolts on top	
	8100064	Bridge Sign Connection, Steel, Type E (old type)	831	0 - 22	0 - 20	5 - 40	2 Columns	4 bolts on top	
	8100065	Bridge Sign Connection, Steel, Type F (old type)	831	0 - 40	0 - 20	5 - 40	3 columns	4 bolts on top	
	8100064	Bridge Sign Connection, Steel, Type E (old type)	899	0 - 22	0 - 20	5 - 40	2 Columns	6 bolts on top	
	8100065	Bridge Sign Connection, Steel, Type F (old type)	899	0 - 40	0 - 20	5 - 40	3 columns	6 bolts on top	
	12SP810(H)	Bridge Sign Connection, Steel, Modified, Type F	820	0 - 22	0 - 20	0 - 40	2 Columns	New Type F	Web less than 36"
	8100326	Bridge Sign Connection, Steel, Type G	820	0 - 40	0 - 20	0 - 40	3 columns		Web less than 36"
8100327	Bridge Sign Connection, Steel, Type H	830	0 - 22	0 - 20	0 - 40	2 Columns		Web greater than 36"	
8100328	Bridge Sign Connection, Steel, Type I	830	0 - 40	0 - 20	0 - 40	3 columns		Web greater than 36"	
8100329	Bridge Sign Connection, Steel, Type J	830	0 - 40	0 - 20	0 - 40	4 columns		Web greater than 36"	
Removals	8100015	Bridge Sign Connection, Type A, Rem					n/a		
	8100016	Bridge Sign Connection, Type B, Rem					n/a	Steel web connection	
	8100017	Bridge Sign Connection, Type C, Rem				0	2 Columns		
	8100018	Bridge Sign Connection, Type D, Rem				0	3 columns		
	8100019	Bridge Sign Connection, Type E, Rem				5 - 40	2 Columns		
	8100020	Bridge Sign Connection, Type F, Rem				5 - 40	3 columns		
						4 columns	Pay for with 2 Type C or Type E Removals		

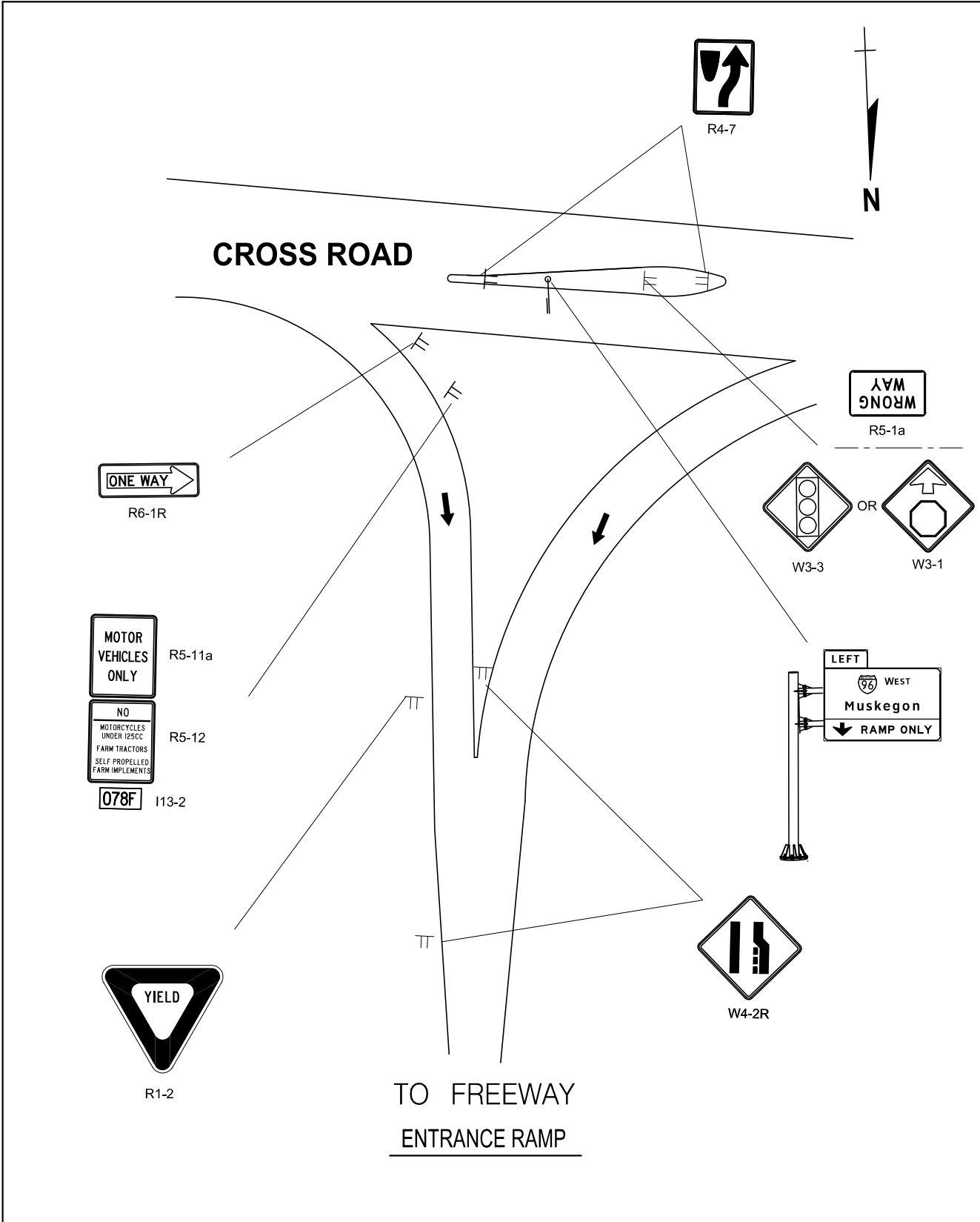

	DDI - Entrance Ramp		
	TRAFFIC AND SAFETY		
DRAWN BY: QHN	07/19/2022		A-12
CHECKED BY: AJU	PLAN DATE:		
FILE: mdot_tsdpag_appendix_a.dgn			REV.



R6-1R



R1-2



R1-2



R3-5L



R3-8g

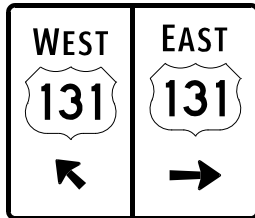

M8-2a

FROM FREEWAY

EXIT RAMP



TRAFFIC AND SAFETY

DDI - Exit Ramp

DRAWN BY: QHN

07/19/2022

CHECKED BY: AJU

PLAN DATE:

A-13

FILE: mdot_tsdpag_appendix_a.dgn

REV.

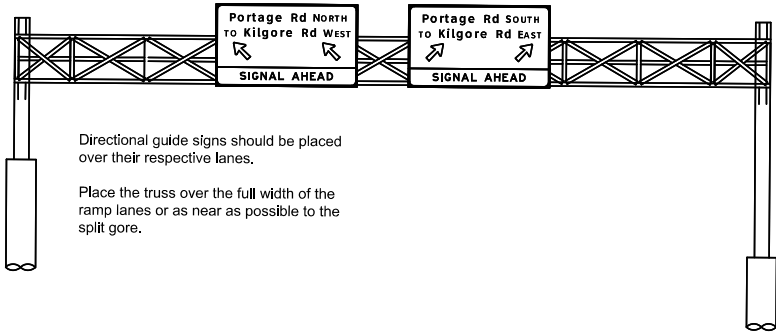

Directional guide signs should be placed over their respective lanes.

Place the truss over the full width of the ramp lanes or as near as possible to the split gore.

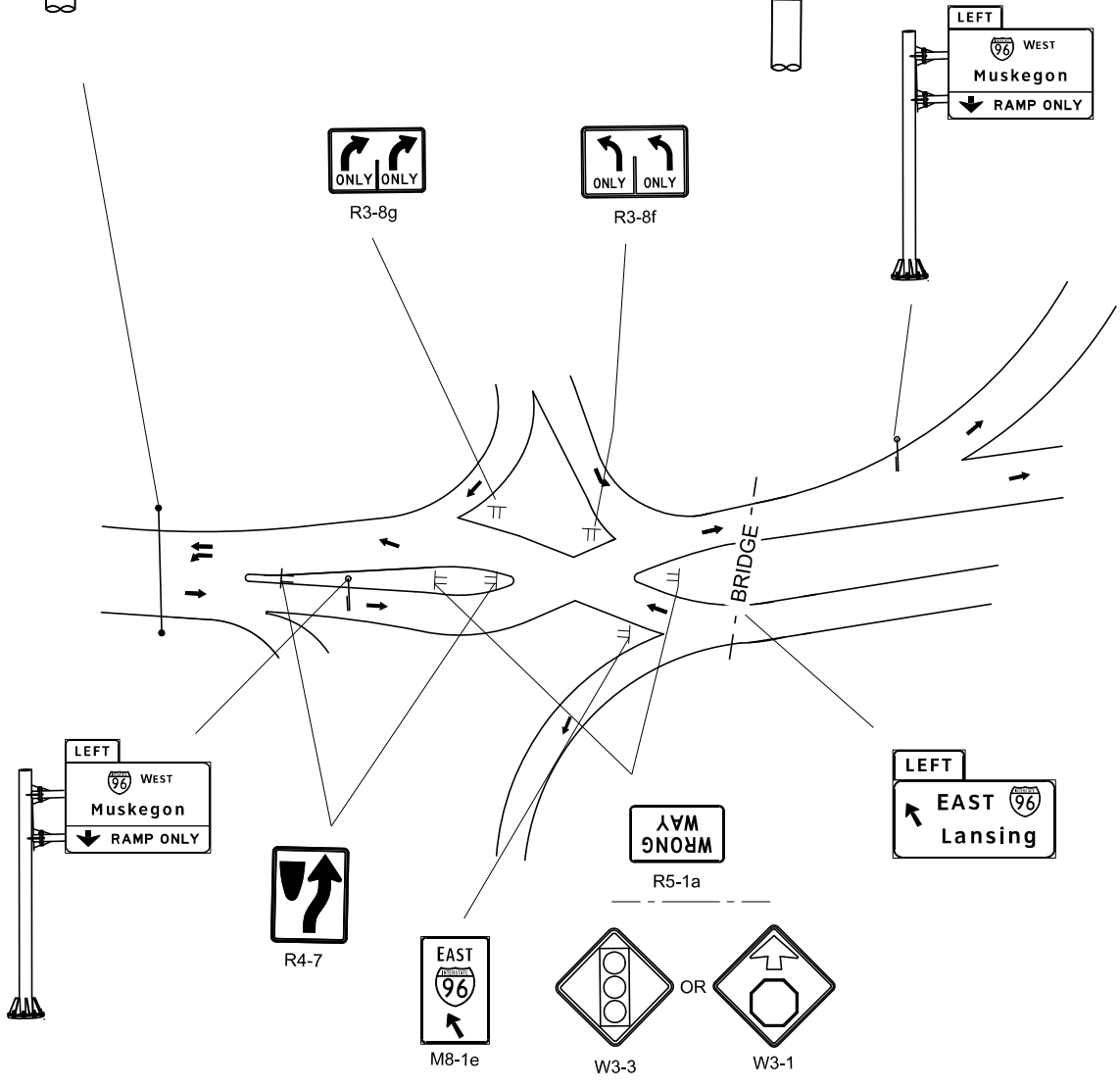

CROSSING AREA

	DDI - Crossing Area		
	TRAFFIC AND SAFETY		
DRAWN BY: QHN	07/19/2022		A-14
CHECKED BY: AJU	PLAN DATE:		
FILE: mdot_tsdpag_appendix_a.dgn			REV.

N

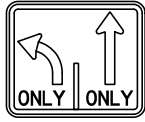

R3-8c

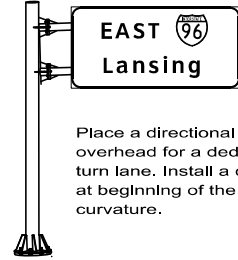

Place a directional guide sign overhead for a dedicated right turn lane. Install a cantilever at beginning of the ramp curvature.

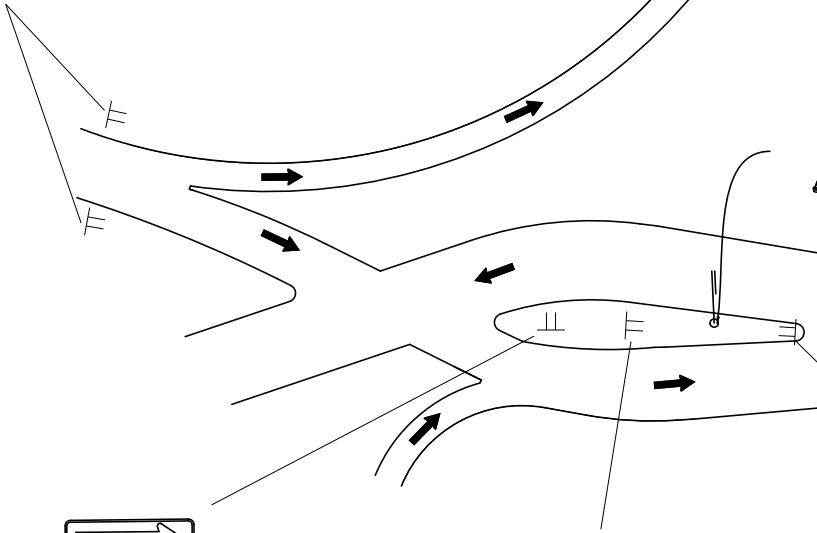

R6-1R



R5-1a



R4-7

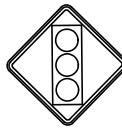

W3-3

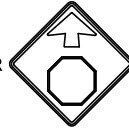

W3-1

OR

ARRIVAL AND DEPARTURE



TRAFFIC AND SAFETY

DDI - Arrival and Departure

DRAWN BY: QHN

CHECKED BY: AJU

07/19/2022

PLAN DATE:

A-15

FILE: mdot_tsdpag_appendix_a.dgn

REV.

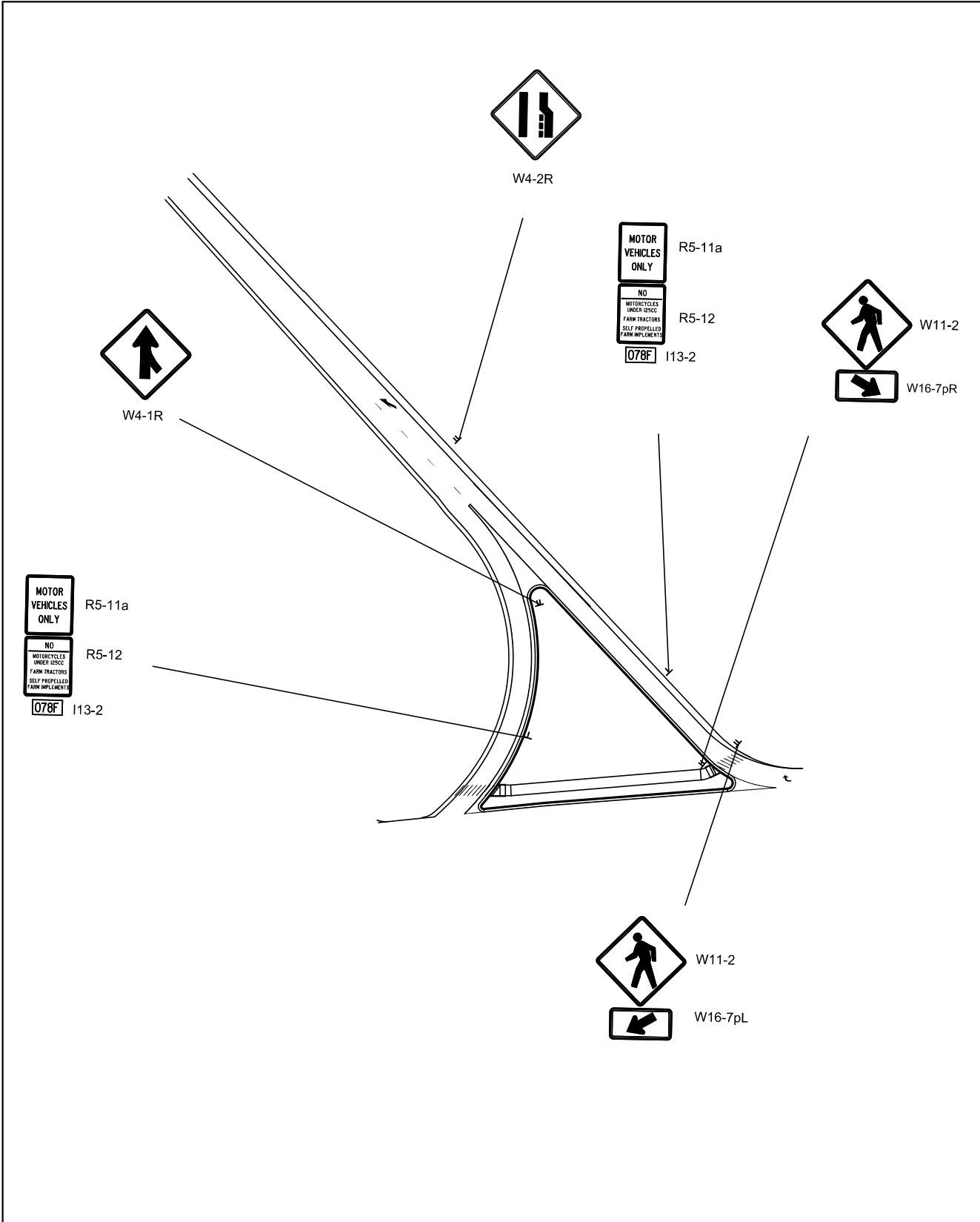

<p>MDOT Michigan Department of Transportation</p> <p>TRAFFIC AND SAFETY</p>	<p>SPUI - Entrance</p>	
	<p>DRAWN BY: QHN</p> <p>CHECKED BY: AJU</p> <p>FILE: mdot_tsdpag_appendix_a.dgn</p>	<p>07/19/2022</p> <p>PLAN DATE:</p>

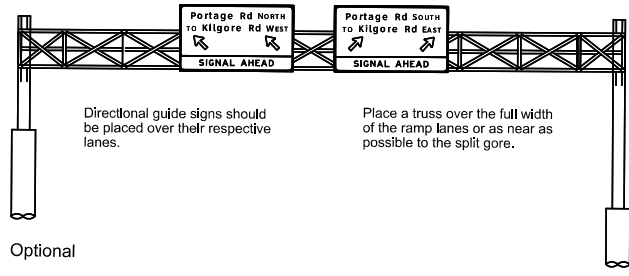
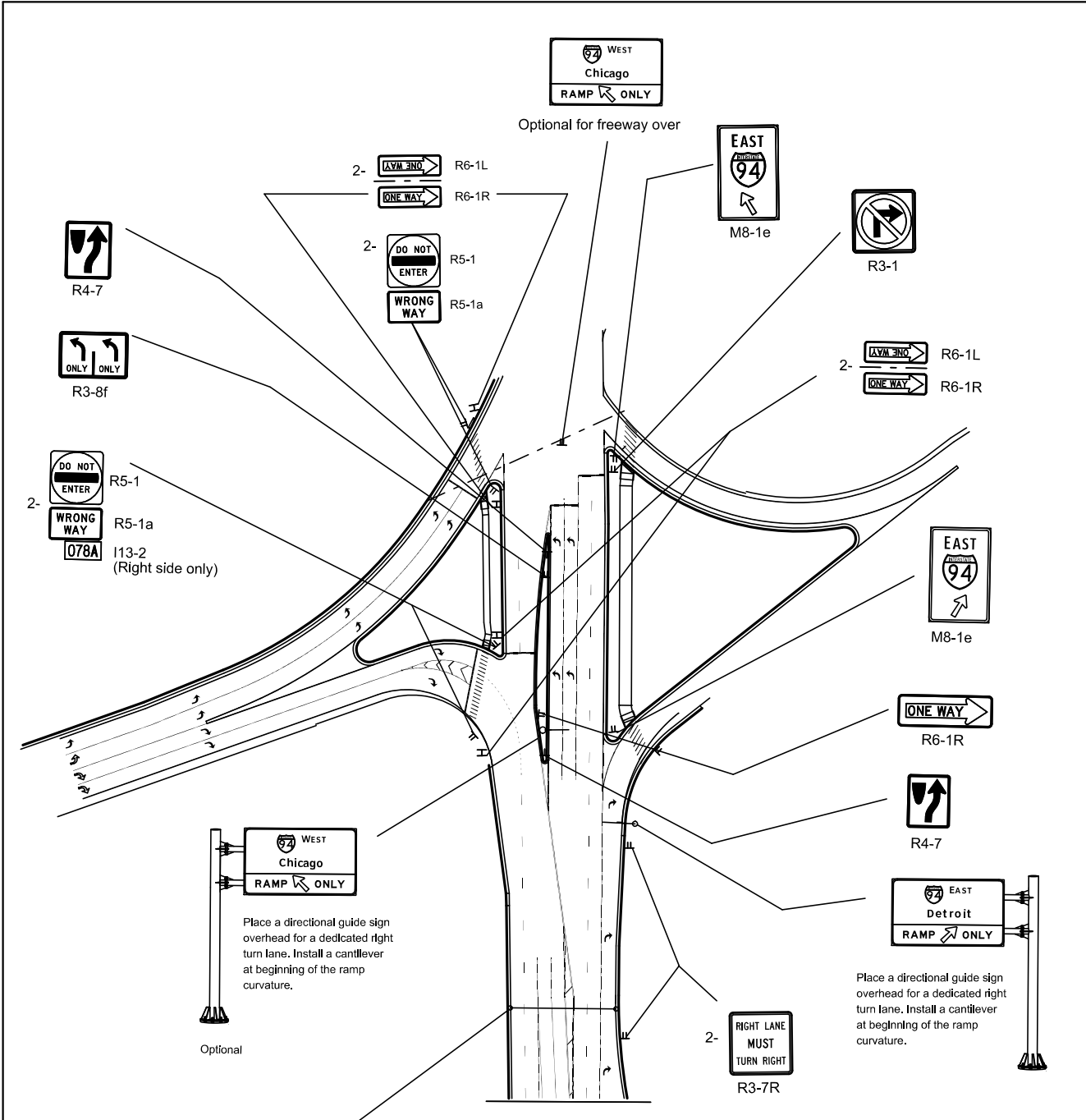

<p>TRAFFIC AND SAFETY</p>	<p>SPUI - Crossing Area/ Arrival and Departure</p>		
	<p>DRAWN BY: QHN</p>	<p>07/19/2022</p>	
	<p>CHECKED BY: AJU</p>	<p>PLAN DATE:</p>	<p>A-17</p>
	<p>FILE: mdot_tsdpag_appendix_a.dgn</p>	<p>REV.</p>	

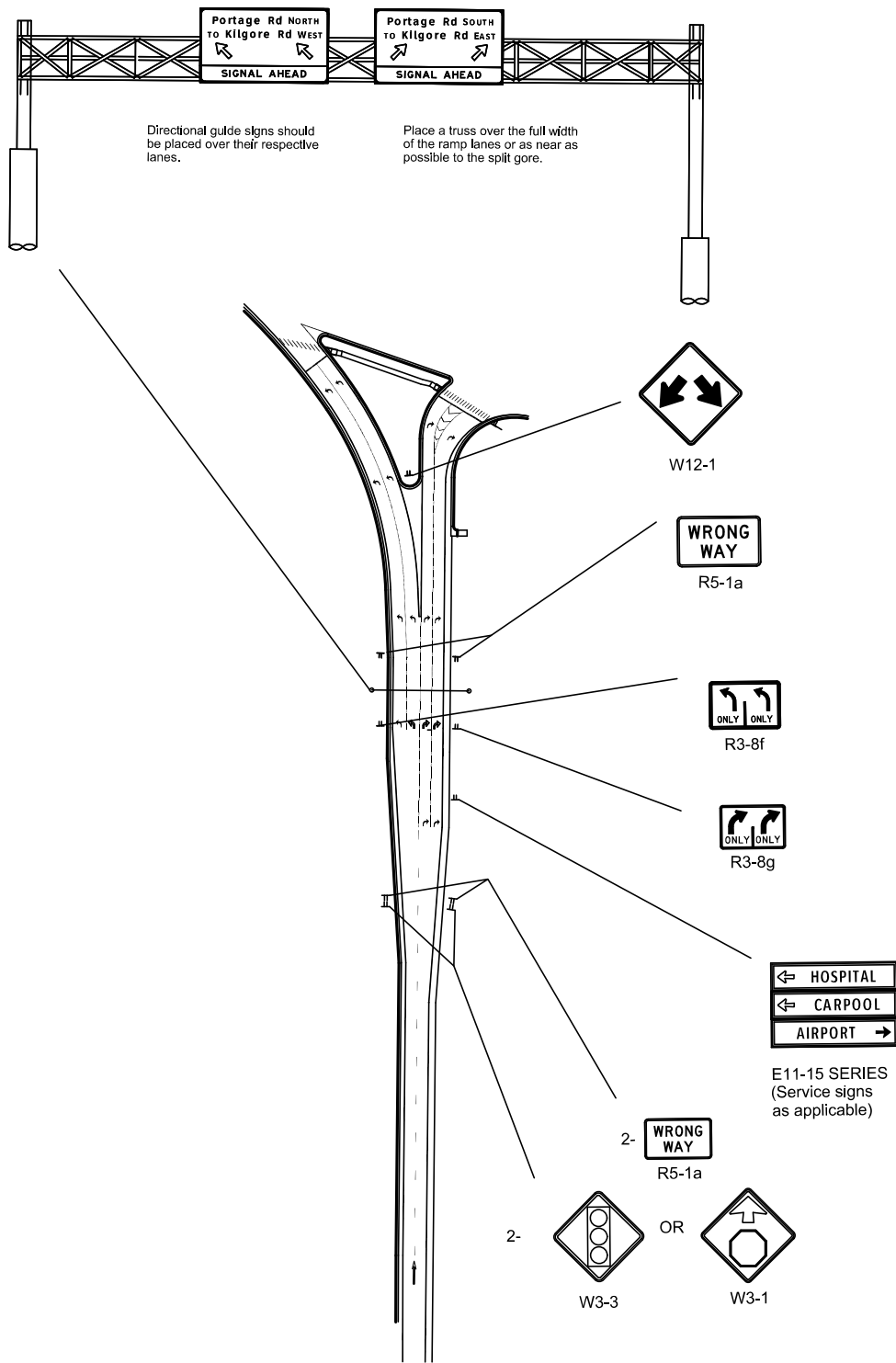

TRAFFIC AND SAFETY

SPUI - Exit

DRAWN BY: QHN
CHECKED BY: AJU

07/19/2022
PLAN DATE:

A-18

FILE: mdot_tsdpag_appendix_a.dgn

REV.

APPENDIX B
Sign Layouts

Guidelines for Sign Combinations

1. STOP (R1-1) – Street name, ONE-WAY, turn prohibition, ALL WAY, divided highway crossing, DO NOT ENTER, and CROSS TRAFFIC DOES NOT STOP signs.
2. YIELD (R1-2) – Same as No. 1 except for last listing, R1-2aP.
PEDESTRIAN YIELD –(R1-5L, R1-5R, R1-5aL, R1-5aR. R1-6, R1-6a, R1-10P)
3. SPEED LIMIT (R2-1, R2-1a, R2-2 R2-2P, R2-2a, R2-3P, R2-4, R2-4a, R2-4b, R2-4P) –
Parking control signs, S5-2
4. TURN PROHIBITION (R3-1, R3-2, R3-3) – Street name, ONE-WAY, STOP, and YIELD signs
5. U-TURN PROHIBITION (R3-4, R3-18) – Parking control signs
6. LANE-USE CONTROL – Parking control signs only on R3-7s and R3-8s
7. TWO WAY LEFT TURN ONLY (R3-9b, and R3-9c) – Parking control signs only on R3-9b and R3-9c.
8. PREFERENTIAL LANE (R3-10, R3-11, R3-12, R3-13, R3-14, R3-15, R3-17 - R3-27) –
Parking control signs except for R3-14 and R3-15
9. COMPLETE LEFT TURN WHEN TRAFFIC CLEARS (R3-30) – No U Turn sign
10. TURN RIGHT (LEFT) ONLY (R3-31, R3-31a) – Street name, ONE-WAY, STOP, and YIELD signs
11. LEFT TURN LANE (overhead) (R3-32) – None
12. SIGNAL MOVEMENT IDENTIFICATION CASE SIGN (R3-33, R3-33a, R3-33b) – None
13. DO NOT PASS (R4-1) – Parking control signs
14. PASS WITH CARE (R4-1a) – Parking control signs
15. SLOWER TRAFFIC KEEP RIGHT (R4-3, R4-4) – Parking control signs
16. TRUCKS USE RIGHT LANE (R4-5) – Parking control signs
17. KEEP RIGHT (LEFT) (R4-7, R4-7a, R4-7b, R4-7c, R4-8, R4-9, R4-9a, R4-10, R4-16, R4-17, R4-18) – None

18. DO NOT ENTER (R5-1) – WRONG WAY sign
19. WRONG WAY (R5-1a, R5-1b) – DO NOT ENTER sign
20. SELECTIVE EXCLUSION (R5-2 through R5-16a, R5-18, R5-a, R5-b, R5-c, R5-d, R5-e)
– Can be combined with most any guide sign (Exceptions: R5-15 and 16 are special purpose signs for freeways and should not be combined with other signs.)
21. ONE WAY (R6-1, R6-2) – Street name, turn prohibition, STOP, and YIELD signs
22. DIVIDED HIGHWAY CROSSING (R6-3, R6-3a, R6-4, R6-4a, R6-4b, R6-5P, and R6-6, R6-7, R6-11) – STOP and YIELD signs
23. PARKING (R7, R8) – Can be combined with most any other sign except for STOP and YIELD signs, or as otherwise noted in these guidelines.
24. PEDESTRIAN (R9) – Same as No. 24 (Exceptions: R9-4b)
25. TRAFFIC SIGNAL (R10-1, R10-2, R10-3, R10-4) – Can be combined with any other sign near traffic signal
TRAFFIC SIGNAL (R10-5, R10-6, R10-6a, R10-6b, R10-7, R10-8, R10-10, R10-11, R10-11a, R10-11b, R10-11c, R10-11d, R10-12, R10-13, R10-14, R10-14a, R10-14b, R10-15, R10-16, R10-17a, R10-20aP, R10-21, R10-22, R10-23, R10-23a, R10-23b, R10-30, R10-31P, R10-32P) – None
26. KEEP OFF MEDIAN (R11-1) – None
27. ROAD CLOSED (R11-2, R11-3a, R11-3b, R11-4) – None
28. WEIGHT LIMIT (R12-1, R12-2, R12-3, R12-4, R12-5, R12-7, R12-7aP) – Parking control signs
29. WEIGHT LIMIT (R12-8, R12-9, R13-1, R13-1a, R13-1b, R13-1c, R13-2) – Parking control and most any guide sign
30. TRUCK ROUTE (R14-1, R14-2, R14-3, R14-4, R14-5, R-15, R16-1, R17's) – Parking control and most any guide sign Not sure
31. TURN & CURVE (W1-1, W1-1a, W1-2, W1-2a, W1-3, W1-4, W1-5, W1-10, W1-11, W1-13, W1-15) – Parking control signs and advisory speed (when applicable)
32. LARGE ARROW (W1-6, W1-7) – Route marker directional assembly

33. CHEVRON (W1-8) – None
34. CROSS ROAD etc. (W2-1, W2-2, W2-3, W2-4, W2-5, W2-6, W2-7, W2-8) – (W16-8P) and parking control signs.
35. STOP, YIELD, SIGNAL AHEAD (W3-1, W3-2, W3-3, W3-5, W3-5a, W3-5b, W3-6) – Parking control signs
36. MERGE (W4-1, W4-3, W4-5, W4-6) – None
37. LANE ENDS (W9-1, W9-2) – Parking control signs
38. PAVEMENT WIDTH TRANSITION (W4-2, W4-4P, W4-4aP, W4-4bP) – Parking control signs
39. ROAD NARROWS (W5-1) – Parking control signs
40. NARROW BRIDGE (W5-2) – Parking control signs
41. ONE LANE BRIDGE (W5-3, W5-4, W5-4a) – Parking control signs
42. DIVIDED HIGHWAY (W6-1, W6-2, W6-3, W6-4, W6-5) – Parking control signs
43. FREEWAY ENDS (Roadside) (W19-1) – None
44. HILL (W7-1, W7-1a,) – None, except supplemental plaques W7-2, W7-2b, W7-3, W7-3a, and W7-3b
45. RUNAWAY TRUCK RAMP - (W7-4, W7-4b, W7-5, W7-5aP, W7-6) – W7-4c, W7-4d, W7-4e, and W7-4f
46. BUMP-DIP (W8-1, W8-2) – None, except advisory speed
47. PAVEMENT ENDS (W8-3) – Parking control signs
48. SOFT SHOULDER (W8-4) – None
49. SLIPPERY WHEN WET (W8-5, W8-5aP - W11-24) – None
50. DOUBLE ARROW (W12-1) – Object marker
51. CLEARANCE (W12-2, W12-2a, W12-3, W12-3a) – Parking control signs except for W12-3 and W12-3a signs

52. ADVISORY SPEED (W13-1P) – Turn, curve, and other selected warning signs
53. ADVISORY EXIT (RAMP) SPEED (W13-2, W13-3, W13-3c, W13-3d, W13-4P) (W13-6, W13-6a, W13-7, W13-7a) – None
54. DEAD END (W14-1, W14-2) – End of roadway marker or parking control signs when Dead End signs are used in advance of end of road
55. NO PASSING ZONE (Pennant) (W14-3) – None (Signs may be placed on the back of this sign for opposite direction traffic if it does not change the pennant shape.)
56. PLAYGROUND (W15-1, W17-1 – W25-2) – Parking control signs
57. VEHICULAR TRAFFIC SIGNS – Supplemental plaques (W16-1, W16-2, W16-2a, W16-3, W16-3a, W16-4, W16-4a, W16-5P, W16-6P, W16-7P, W16-8P, W16-8aP, W16-9p, W16-10P, W16-10aP, W16-11P, W16-12P, W16-13P, W16-15P, W16-17P, W16-18P)
58. NONVEHICULAR SIGNS – Supplemental plaques (W16-2, W16-2a, W16-3, W16-3a, W16-4) When used at crossing, shall use W16-7p.
59. INTERSTATE ROUTE MARKER (M1-1) – Parking control signs when used as a confirmatory sign on free access; cardinal direction and route marker arrow, as appropriate
60. OFF-INTERSTATE BUSINESS ROUTE MARKER (M1-2, M1-3) – Same as No. 61
61. US, COUNTY, MICHIGAN & FOREST ROUTE MARKERS (M1-4, M1-5, M1-5a, M1-6, and M1-7) (M1-8, M1-9, M1-10, M1-10a) – Same as No. 62
62. AUXILIARY PANELS (M-1, M2-2, M2-2a, M2-2b, M2-2c, M2-3, M2-4, M2-5, M2-6, M2-7 and M8's) – Combine with route markers as appropriate
63. DESTINATION and DISTANCE (D1, D2) – Parking control signs (Route markers may also be integrated with direction signs when placed overhead or at the roadside if space is available for larger sign layouts)
64. STREET NAME (D3-1, D3-2, D3-2a, D3-2b, D3-2c) --
 - D3-1 – STOP and YIELD signs
 - D3-2 – Parking control signs
 - D3-2a (W16-8P) – Intersection warning signs
65. PARKING (symbol) (D4-1) – Can be combined with most other signs except for STOP and YIELD signs, or as otherwise noted in these guidelines.

66. PARK & RIDE (D4-2) (D4-3, D4-4, D4-4a, D4-4b, D4-4c) – Parking control signs
67. REST AREA and SCENIC AREA (D5, D6) – Can be combined with most any other sign except STOP and YIELD. On freeway signs – none
68. RECREATIONAL and CULTURAL INTEREST (D7-1, D7-1a, D7-1b, D7-1c, D7-1d, D7-2) (D7-3) – Same as No. 69
69. WEIGH STATION (D8) – None
70. GENERAL SERVICE and AUXILIARY (D9) – Can be combined with other guide signs if the amount of legend is not too great. On freeway signs - none
71. MILE MARKERS (D10-1, D10-2, D10-3, D10-4, D10-5, D11-1, D11-2) – None
72. SNOWMOBILE and AUXILIARY PANELS (D11-5) – Can be combined with other guide signs if the amount of legend is not too great.
73. GENERAL INFORMATION (I2 through I10) – Ordinarily, these signs may be combined with any other sign except STOP and YIELD, providing the amount of legend does not interfere with a clear understanding of all signs in the same installation. [The River Name (I3-1) sign can often be combined with the Object Marker (OM-3) sign.]
74. FREEWAY – Freeway signs should not be combined except where the signs are designed to supplement each other.
75. CONSTRUCTION – The combining of signs in construction areas should follow the same general guidelines as set forth for signs previously described
76. SCHOOL – (S1-1) – For advance warning, shall use W16-2, W16-2a, or W16-9p. At crossing shall use W16-7p.
77. SCHOOL SPEED (R2-1 and S4) – None, except as specified in Part 7 of the MMUTCD
78. RAILROAD CROSSING (R15-1, R15-2) – None except as specified in Part 8 and 10 of the MMUTCD
79. RAILROAD ADVANCE WARNING (W10-1) – R4-1 (if appropriate), W10-1a (if appropriate), parking control signs, and W16-10 (if appropriate).
80. DO NOT STOP ON TRACKS (R8-8) – None
81. BICYCLE SIGNS – The same general principles of sign combinations as outlined for motor vehicle operators can be applied to signing for bicyclists.

RIGHT LANE
MUST
TURN RIGHT

R3-7R

*Only required when turn lane is greater than 100 ft.

RIGHT LANE
MUST
TURN RIGHT

R3-7R

RIGHT LANE
MUST
TURN RIGHT

R3-7R

OR

RIGHT LANE
ONLY

R3-8i



W4-2R

LANE ENDS AND RIGHT TURN LANE

Note:
Warning signs may
also be required for lane ends
situations (See appropriate
sections of the MMUTCD).



TRAFFIC AND SAFETY

LANE-USE CONTROL SIGNS

DRAWN BY: QHN

07/19/2022

CHECKED BY: AJU

PLAN DATE:

B-7

FILE: mdot_tsdpag_appendix_d.dgn

REV.

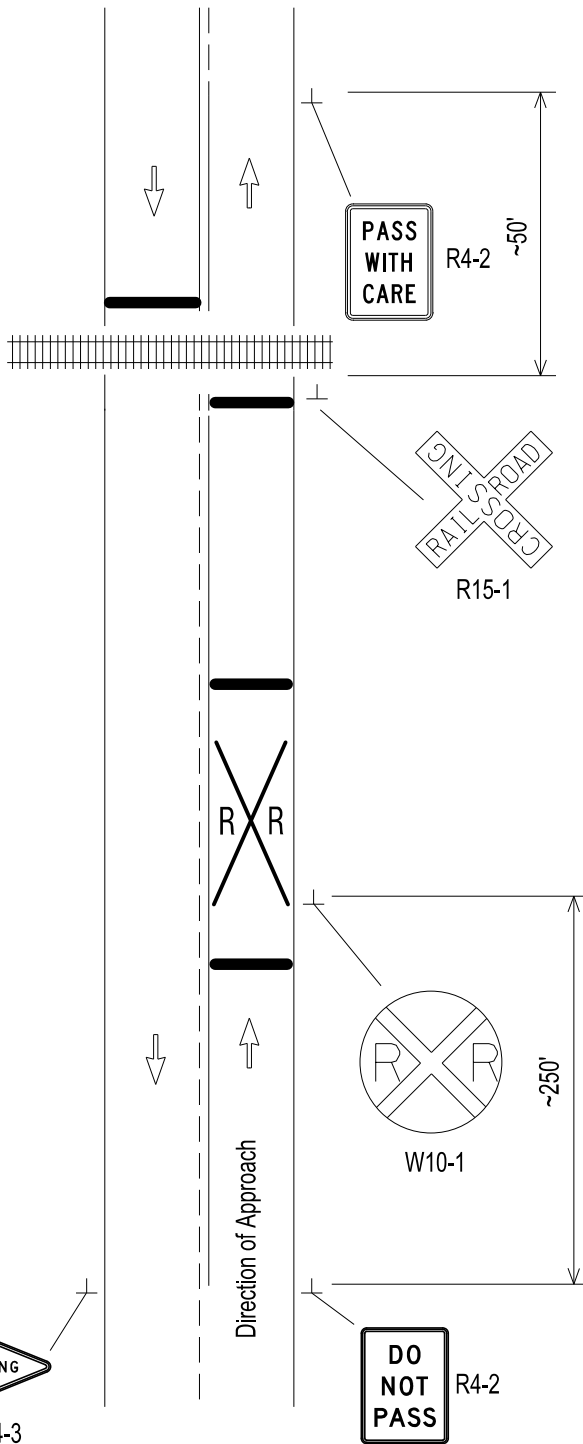

Note:
Signs and pavement markings shown
for one direction only.

 TRAFFIC AND SAFETY	NO PASSING CONTROL AT RAILROAD CROSSINGS	
	DRAWN BY: QHN CHECKED BY: AJU FILE: mdot_tsdpag_appendix_d.dgn	07/19/2022 PLAN DATE:

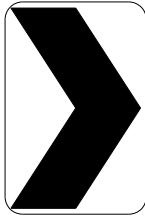

Chevron alignment sign (W1-8) standard sizes
 24" X 30" - Conventional roadways & freeway ramps 20-40 MPH
 36" X 48" - Freeway ramps 45-55 MPH & freeway mainline

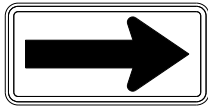

W1-6R (Optional)

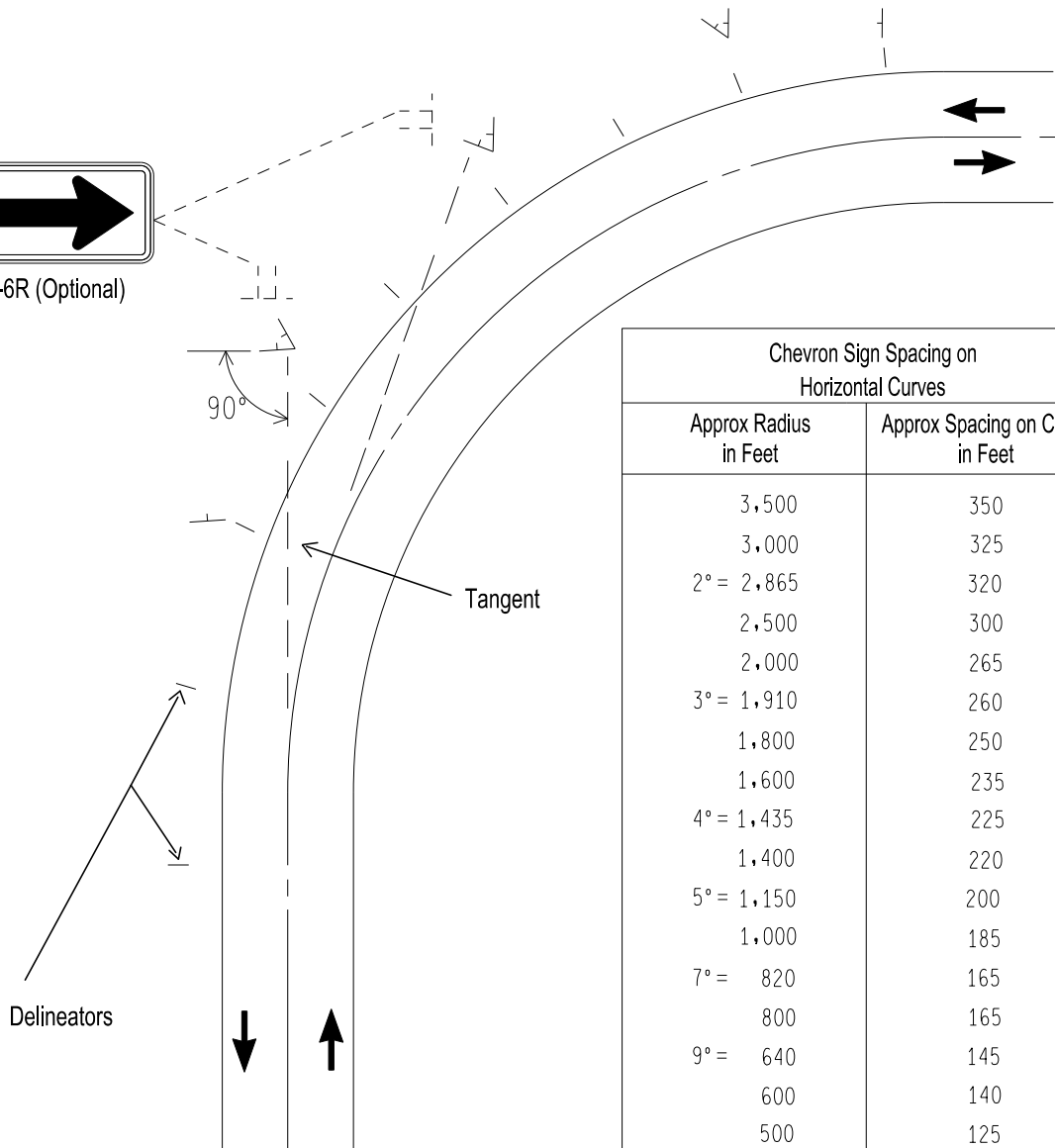

Chevron Sign Spacing on Horizontal Curves	
Approx Radius in Feet	Approx Spacing on Curve in Feet
3,500	350
3,000	325
2° = 2,865	320
2,500	300
2,000	265
3° = 1,910	260
1,800	250
1,600	235
4° = 1,435	225
1,400	220
5° = 1,150	200
1,000	185
7° = 820	165
800	165
9° = 640	145
600	140
500	125
12° = 480	125
15° = 385	110
300	95
275	90
230	80
30° = 195	70
40° = 145	60
100	40

Notes:

1. The appropriate spacing "S" on the curve is found from the formula $S = 6\sqrt{R-50}$ where "R" is the radius curve in feet.
2. The signs should be spaced evenly.
3. The target arrow replaces a chevron, it is not additional to the chevrons.
4. If a target arrow is used, a target arrow in each direction should be placed first in target position and then the chevrons evenly spaced after that.
5. Do not attach chevron signs to existing sign installation or spaced delineators.

MDOT
 Michigan Department of Transportation

TRAFFIC AND SAFETY

DRAWN BY: QHN
 CHECKED BY: AJU
 FILE: mdot_tsdpag_appendix_d.dgn

ROADWAY DELINEATION

07/19/2022
 PLAN DATE:

B-9

REV.

ADVISORY SPEED SIGN WARRANTS FOR RAMPS WITH LIMITED VISIBILITY

General Note:

Overhead advisory speed signs are considered supplemental and do not replace the ground mounted W13-6 or W13-7 signs.

WARRANTS:

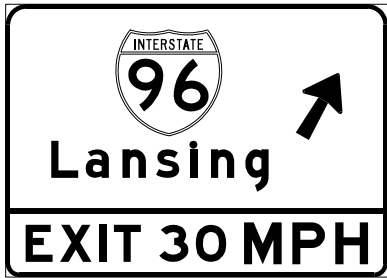

← E6 Series

← E13-2 (Exit)
OR
E13-2a (Ramp)

An extreme reduction in speed use only when advisory speed is less or equal to 30 mph is required to negotiate the ramp.

A crash analysis indicates a history of rollover or run-off-road crashes.



← W1-1R

← W13-1p

DIAGRAMMATIC
(ROADSIDE)

OR



← W16-19

DIAGRAMMATIC
(OVERHEAD OR ROADSIDE)

WARRANT:

The diagrammatic sign should have very limited use. Use only when other signing treatments have proven to be ineffective. Flashing beacons may be mounted above the sign to improve effectiveness.



TRAFFIC AND SAFETY

ADVISORY SPEED SIGNS FOR RAMPS WITH LIMITED VISIBILITY

DRAWN BY: QHN

07/19/2022

CHECKED BY: AJU

PLAN DATE:

B-10

FILE: mdot_tsdpag_appendix_d.dgn

REV.

Field procedure to determine the radius of curvature (R):

1. Measure 100 ft cord A-B (inside edge of curve)
2. Measure M-O (from midpoint of AB)
3. Read R from table

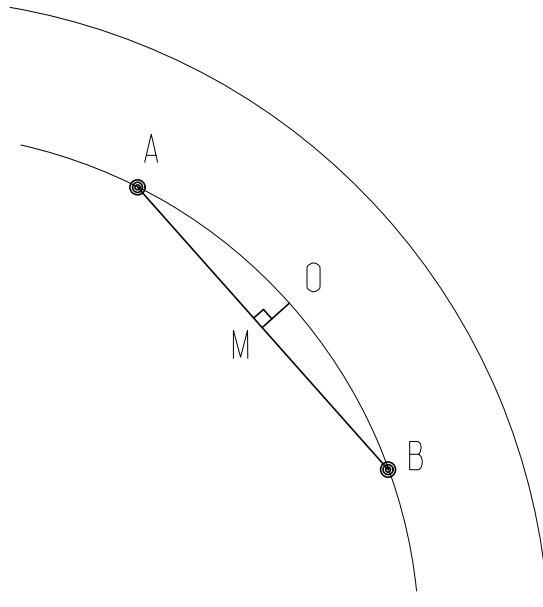

M-O in ft	R in ft
0.22	5730
0.44	2865
0.66	1910
0.87	1432
1.09	1146
1.31	955
1.53	819
1.75	716
1.97	637
2.18	573
2.40	521
2.62	477
2.82	441
3.00	409
3.22	382
3.45	358
3.67	337
3.93	318
4.15	302
4.36	286
4.58	273
4.80	260
5.02	249
5.24	239

Field procedure to determine rate of superelevation (e):

1. Measure W and H at several points on curve (not in transition areas)

2. Calculate e: $e = \frac{H}{W}$

$$f + (0.01)e = \frac{V^2}{15R}$$

Where:

e = Superelevation (%)

f = Side friction

V = Velocity (mph)

R = Radius (ft)

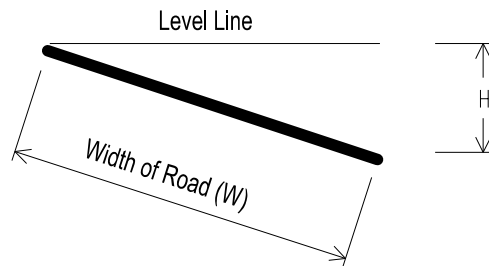

TRAFFIC AND SAFETY

DETERMINATION OF
ADVISORY SPEED
ON CURVES

DRAWN BY: QHN

CHECKED BY: AJU

FILE: mdot_tsdpag_appendix_d.dgn

07/19/2022

PLAN DATE:

REV.

B-11

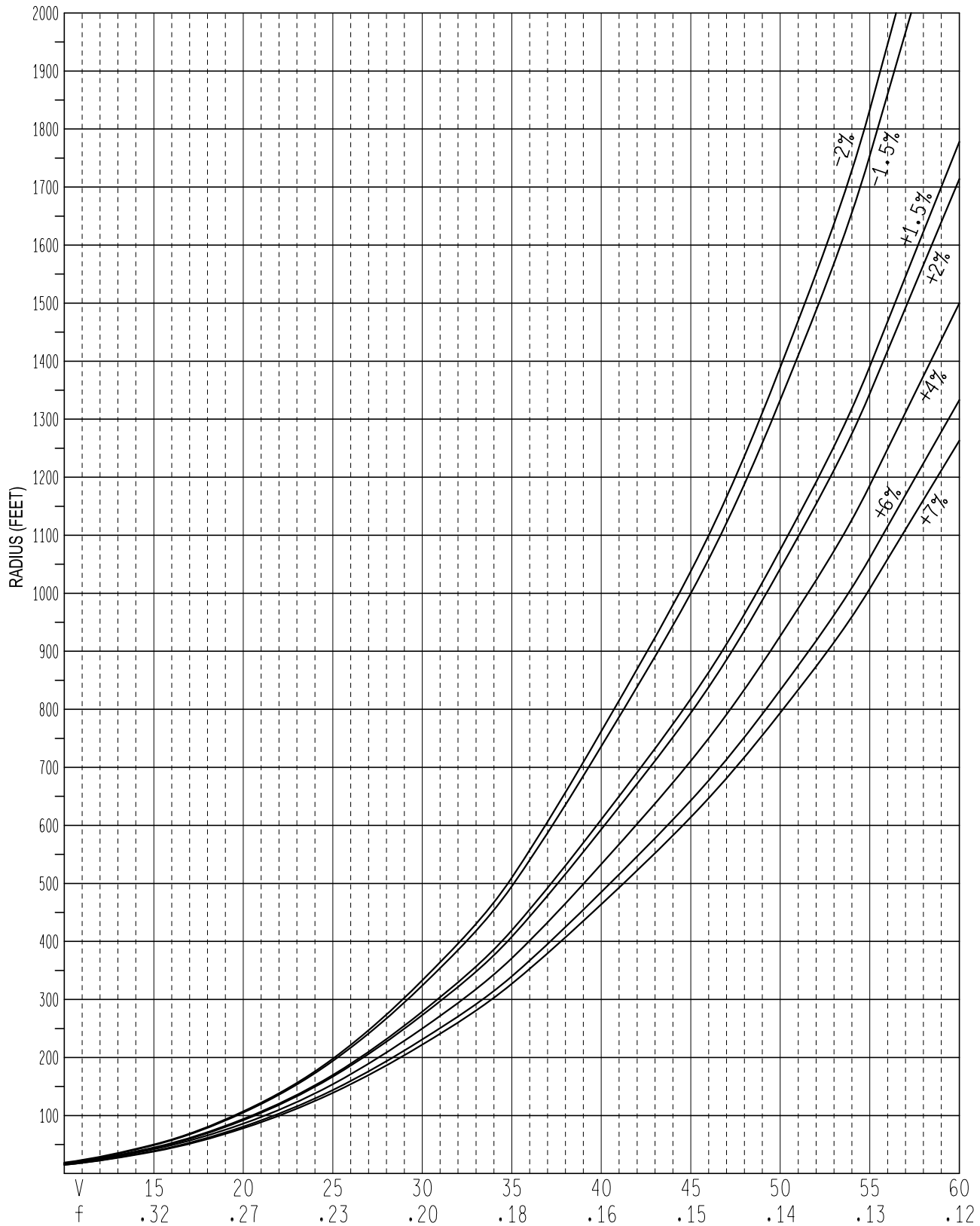

V = Speed in mph
 f = Assumed side friction factor
 from page 3-25 figure 3-6 of
 A Policy on Geometric Design
 of Highways and Streets by
 AASHTO (2011 Edition).



TRAFFIC AND SAFETY

DETERMINATION OF
 ADVISORY SPEED ON CURVES

DRAWN BY: QHN
 CHECKED BY: AJU
 FILE: mdot_tsdpag_appendix_d.dgn

07/19/2022
 PLAN DATE:

B-12

REV.

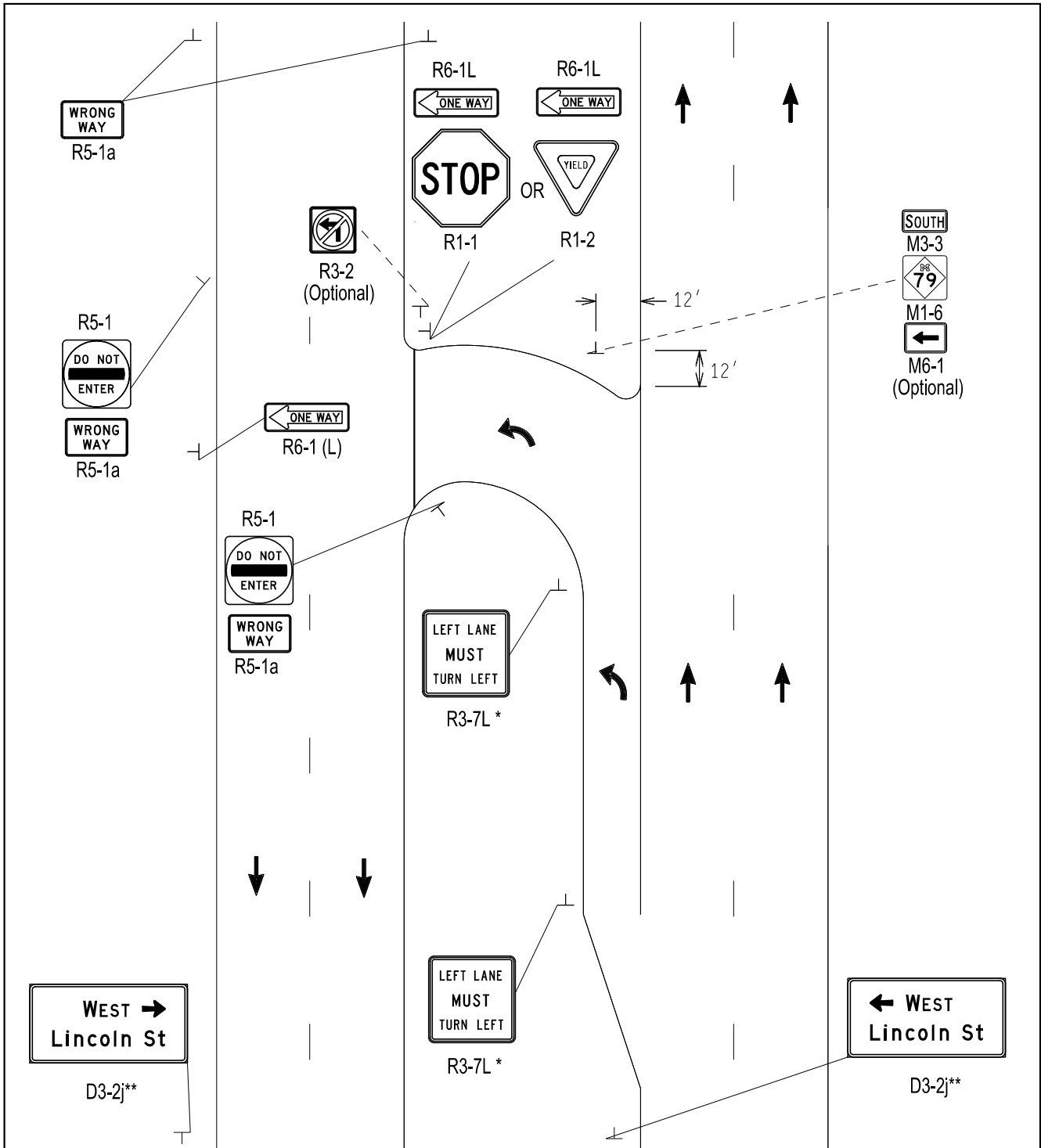

*If the turn lane is greater than or equal to 100 ft in length, place signs at beginning of full width of turn lane and at beginning of taper. If turn lane is less than 100 ft in length, place one sign at beginning of taper only.

**Sign shall not exceed 10 ft in width.

Note:
When crossover is signalized, stop or yield signs are deleted.



TRAFFIC AND SAFETY

SIGNING FOR DIRECTIONAL CROSSOVERS:
SINGLE LEFT DIRECTIONAL CROSSOVER

DRAWN BY: QHN

07/19/2022

CHECKED BY: AJU

PLAN DATE:

B-13

FILE: mdot_tsdpag_appendix_d.dgn

REV.

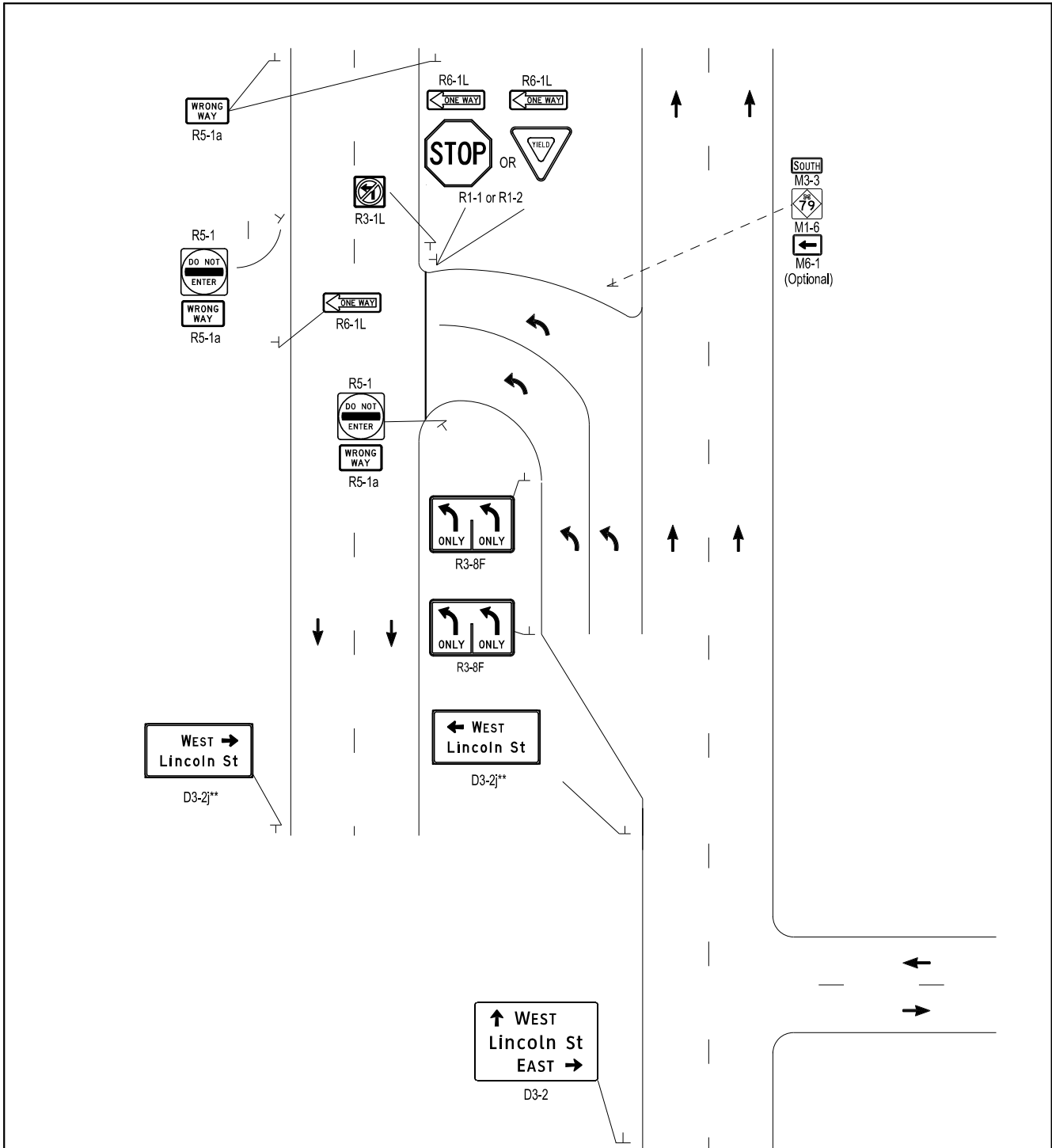

*If the turn lane is greater than or equal to 100 ft in length, place signs at beginning of full width of turn lane and at beginning of taper. If turn lane is less than 100 ft in length, place one sign at beginning of taper only.

**Sign shall not exceed 10 ft in width.

Note:
When crossover is signalized, stop or yield signs are deleted.

	SIGNING FOR DIRECTIONAL CROSSOVERS: DUAL LEFT DIRECTIONAL CROSSOVER	
	TRAFFIC AND SAFETY	
DRAWN BY: QHN CHECKED BY: AJU	07/19/2022 PLAN DATE:	B-14
FILE: mdot_tsdpag_appendix_d.dgn		REV.

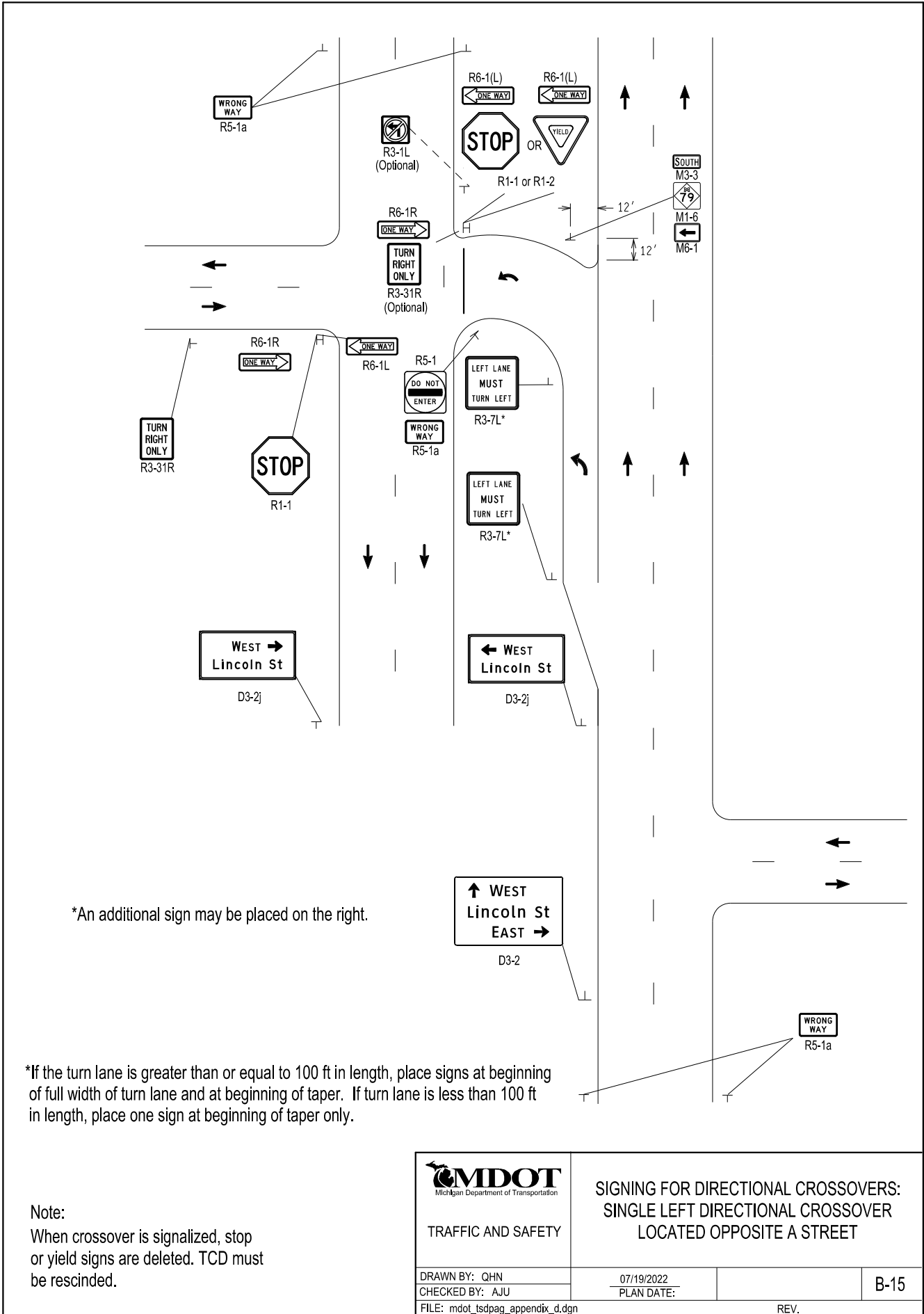

*An additional sign may be placed on the right.

*If the turn lane is greater than or equal to 100 ft in length, place signs at beginning of full width of turn lane and at beginning of taper. If turn lane is less than 100 ft in length, place one sign at beginning of taper only.

Note:
When crossover is signalized, stop or yield signs are deleted. TCD must be rescinded.



TRAFFIC AND SAFETY

**SIGNING FOR DIRECTIONAL CROSSOVERS:
SINGLE LEFT DIRECTIONAL CROSSOVER
LOCATED OPPOSITE A STREET**

DRAWN BY: QHN
CHECKED BY: AJU
FILE: mdot_tsdpag_appendix_d.dgn

07/19/2022
PLAN DATE:

B-15

REV.

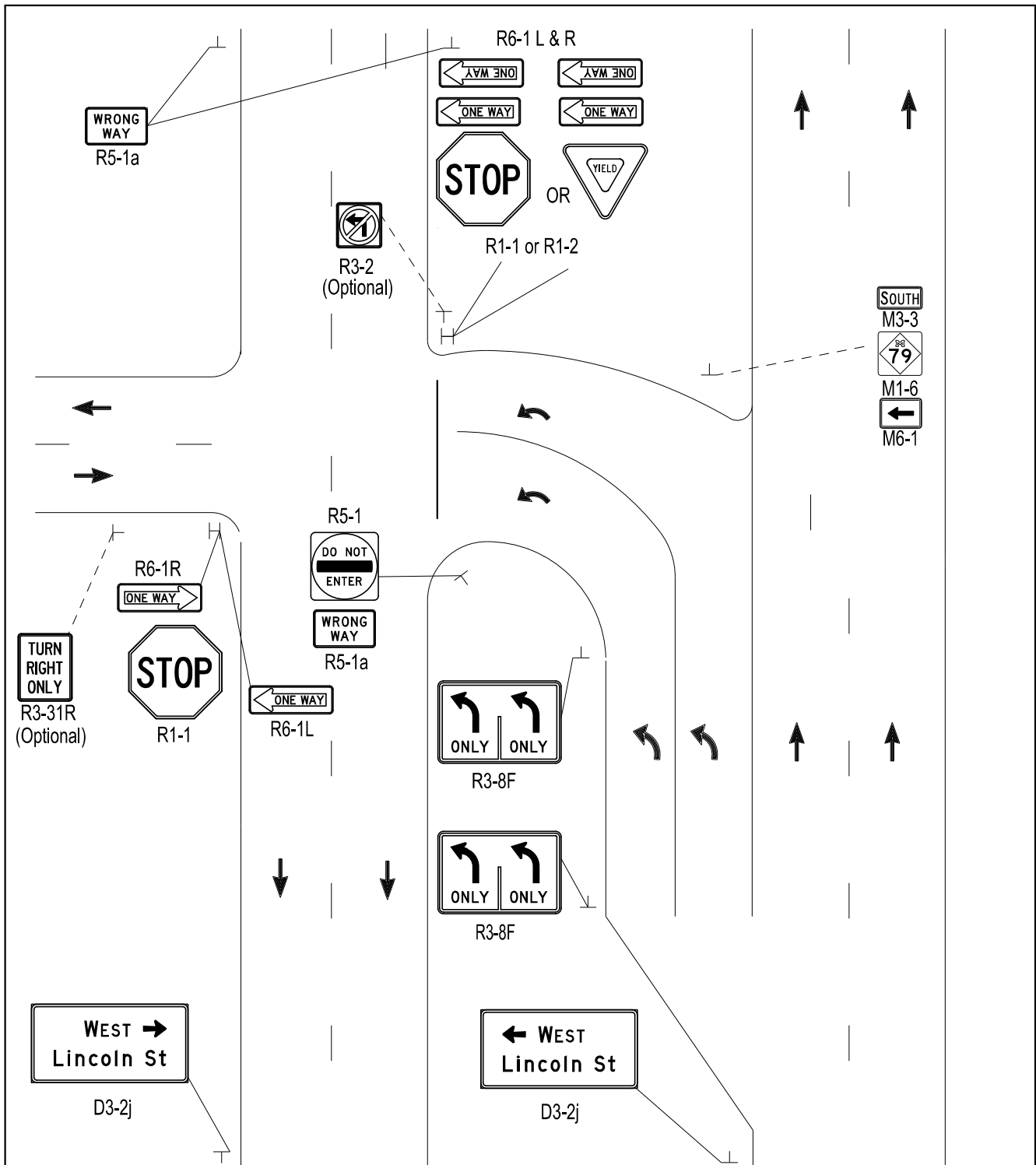

*If the turn lane is greater than or equal to 100 ft in length, place signs at beginning of full width of turn lane and at beginning of taper. If turn lane is less than 100 ft in length, place one sign at beginning of taper only.

Note:

When crossover is signalized, stop or yield signs are deleted. TCD must be rescinded.

MDOT
Michigan Department of Transportation

TRAFFIC AND SAFETY

DRAWN BY: QHN
CHECKED BY: AJU
FILE: mdot_tsdpag_appendix_d.dgn

**SIGNING FOR DIRECTIONAL CROSSOVERS:
DUAL LEFT DIRECTIONAL CROSSOVER
LOCATED OPPOSITE A STREET**

07/19/2022
PLAN DATE:

B-16

REV.

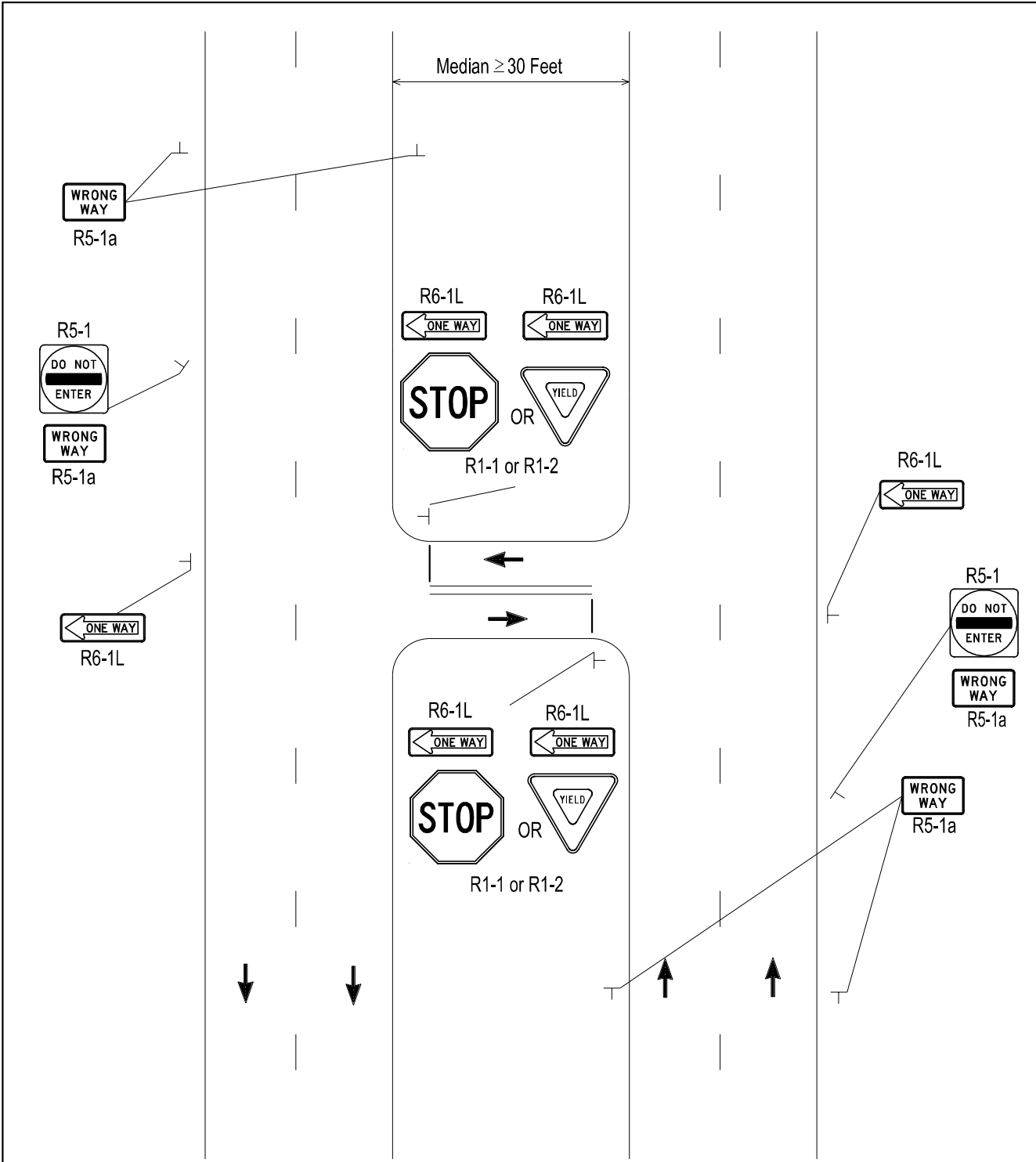

Bi-Directional Median Crossover
Median \geq 30 Feet

Note:
A use of stop or yield requires
TCD (TRAFFIC CONTROL DETERMINATION).

		SIGNING FOR BIDIRECTIONAL CROSSOVER	
TRAFFIC AND SAFETY			
DRAWN BY: QHN	07/19/2022		B-17
CHECKED BY: AJU	PLAN DATE:		
FILE: mdot_tsdpag_appendix_d.dgn			REV.

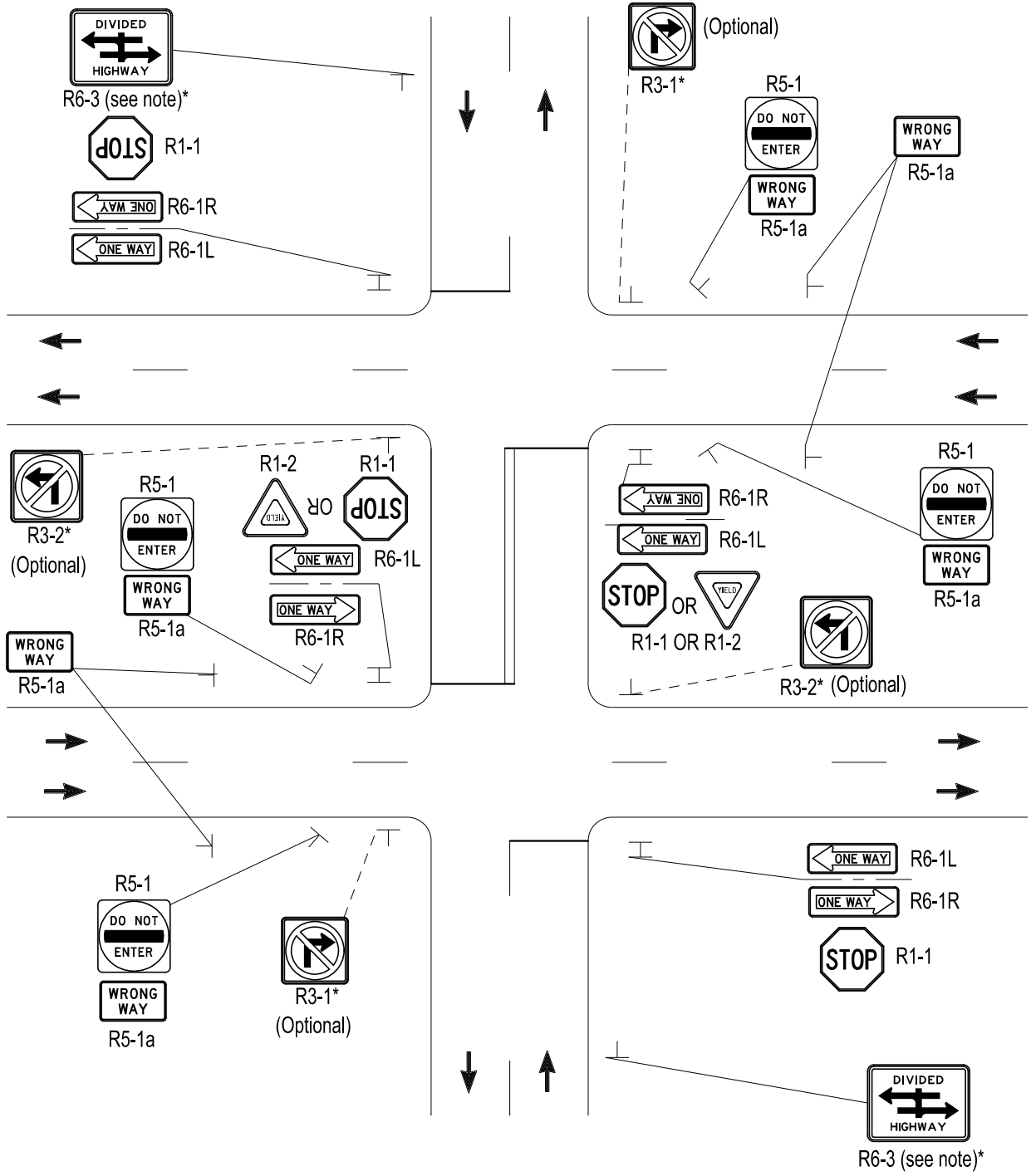

- Notes:
1. If used, the R6-3 sign may be placed beneath the near side R1-1 as an alternate location.
 2. A use of stop or yield requires TCD (TRAFFIC CONTROL DETERMINATION).

<p>TRAFFIC AND SAFETY</p>	<p>SIGNS AT DIVIDED HIGHWAY INTERSECTIONS MEDIAN ≥ 30 FT</p>		<p>B-18</p>
	<p>DRAWN BY: QHN</p> <p>CHECKED BY: AJU</p> <p>FILE: mdot_tsdpag_appendix_d.dgn</p>	<p>07/19/2022</p> <p>PLAN DATE:</p>	

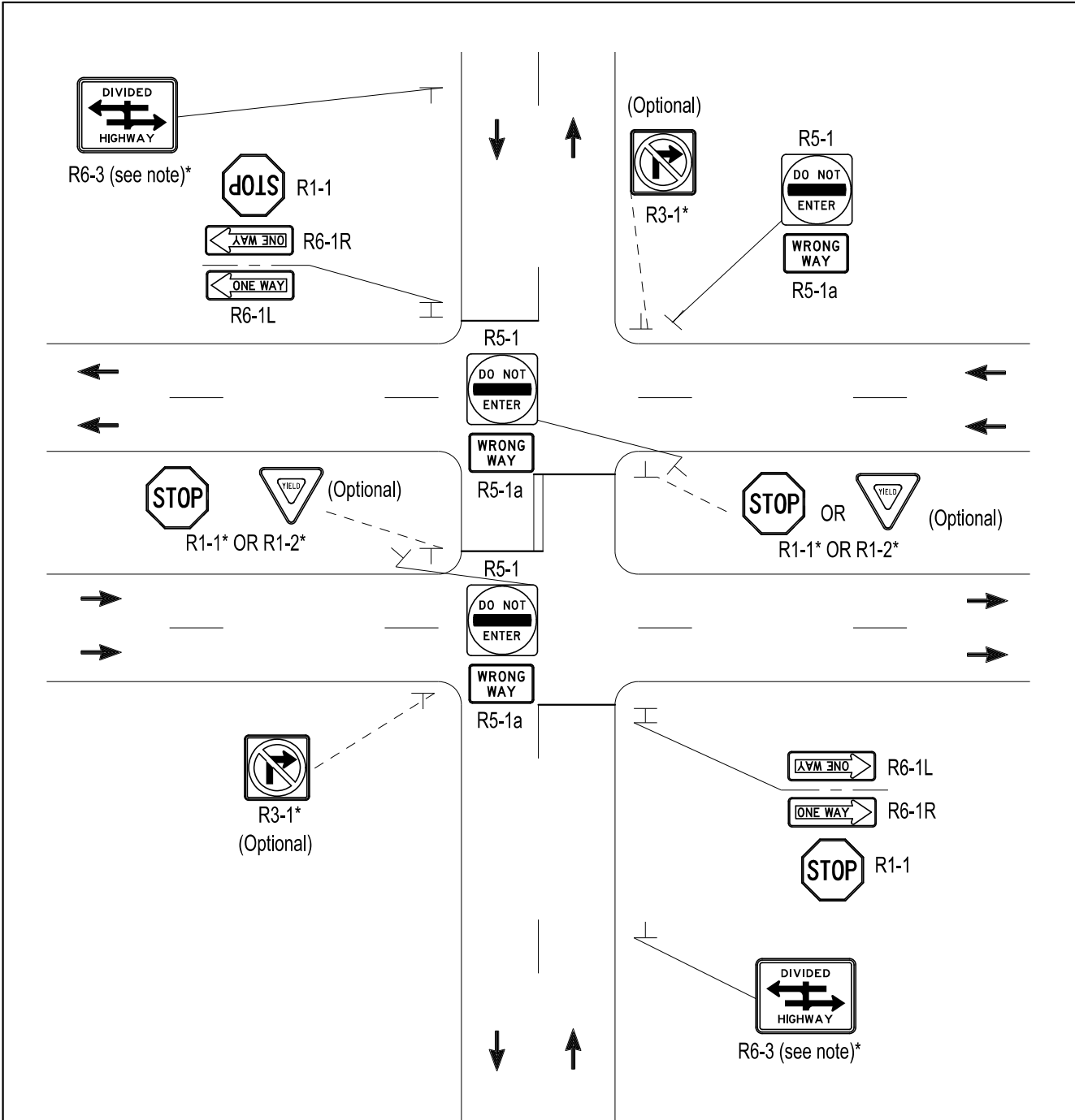

For medians less than 30ft, the signs used should be left to the discretion of the engineer and based on engineering studies, otherwise nothing is required for narrower medians. The road with lowest volume of traffic should be stopped.

Notes:

1. If used, the R6-3 sign may be placed beneath the near side R1-1 as an alternate location.



TRAFFIC AND SAFETY

SIGNS AT DIVIDED HIGHWAY INTERSECTIONS
MEDIAN < 30 FT

DRAWN BY: QHN

07/19/2022

CHECKED BY: AJU

PLAN DATE:

B-19

FILE: mdot_tsdpag_appendix_d.dgn

REV.



D4-4b



D4-4b

150' - 300'

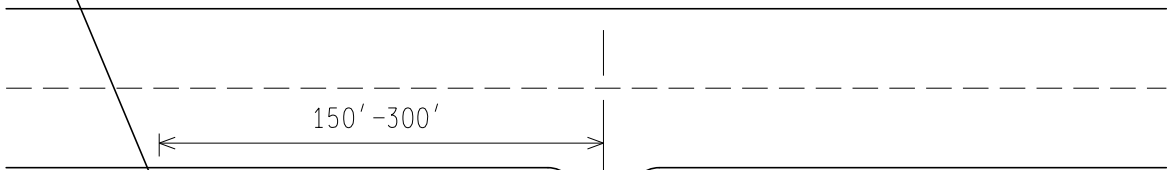

150' - 300'



D4-4b



D4-4b

Alternate placement (back to back - optional)

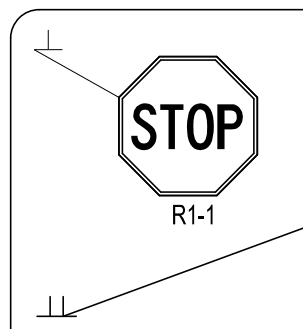

R1-1



I13-1b MDOT Supplied Sign

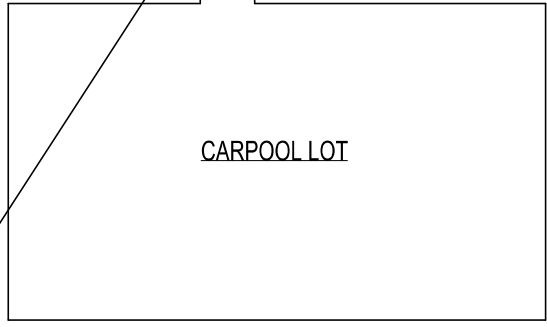

CARPOOL LOT



D4-4



R5-2



AAB-1

Place along back of carpool lot (Optional)



TRAFFIC AND SAFETY

CARPOOL LOT

DRAWN BY: QHN
CHECKED BY: AJU

07/19/2022
PLAN DATE:

B-20

FILE: mdot_tsdpag_appendix_d.dgn

REV.

*A half-mile maximum spacing is recommended. Locate after major (paved) crossroads. Repeat as necessary along added lane.

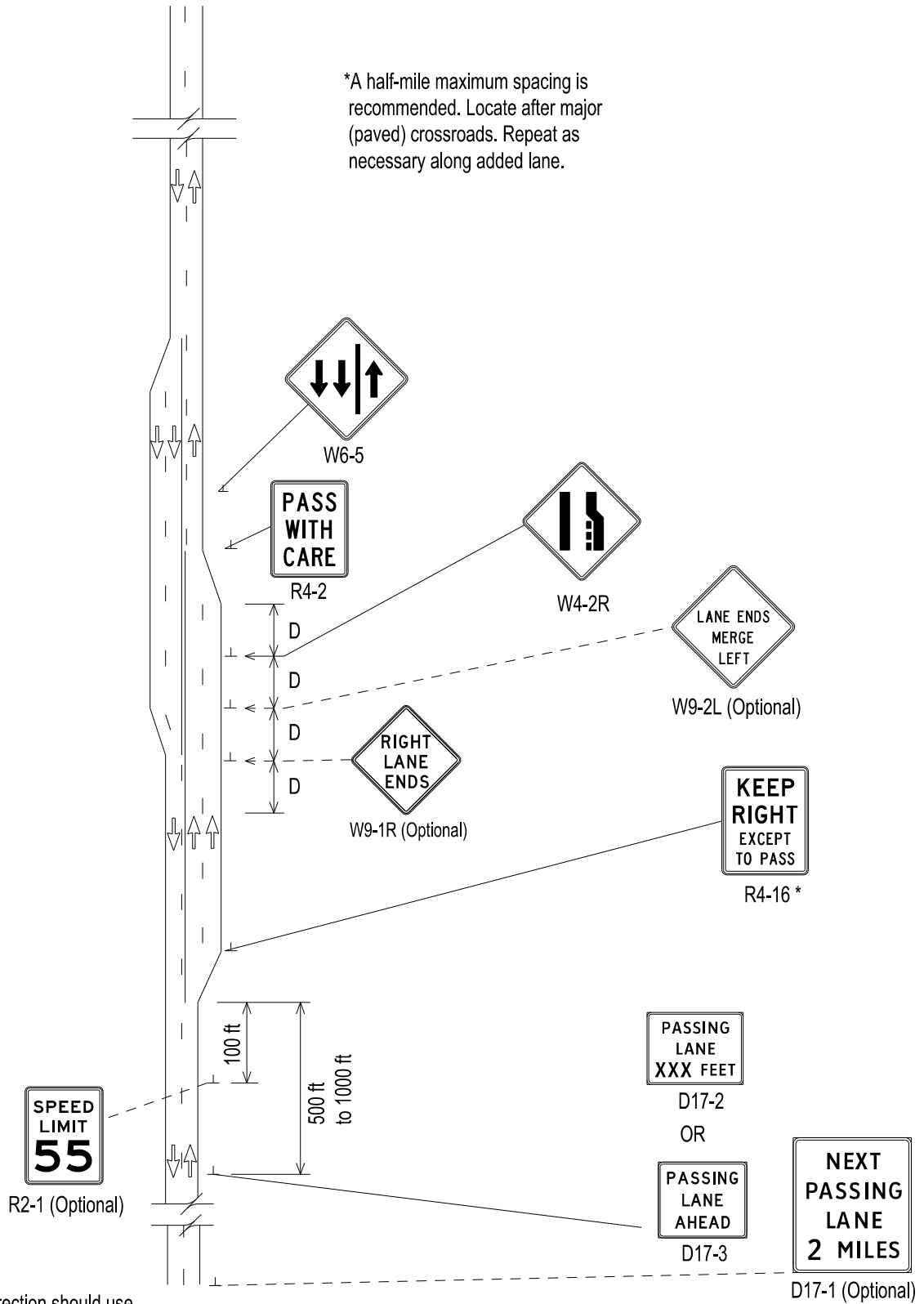

Notes:

1. Opposing direction should use similar signing as required.
2. No sight restriction are assumed. Under actual field conditions, no-passing zones for the single direction may be required.
3. For the distance D, see Table 3.

	TRAFFIC CONTROL PLAN FOR PASSING LANES		
	TRAFFIC AND SAFETY		
DRAWN BY: QHN CHECKED BY: AJU FILE: mdot_tsdpag_appendix_d.dgn	07/19/2022 PLAN DATE:		B-21
			REV.

*A half-mile maximum spacing is recommended. Locate after major (paved) crossroads. Repeat as necessary along added lane.

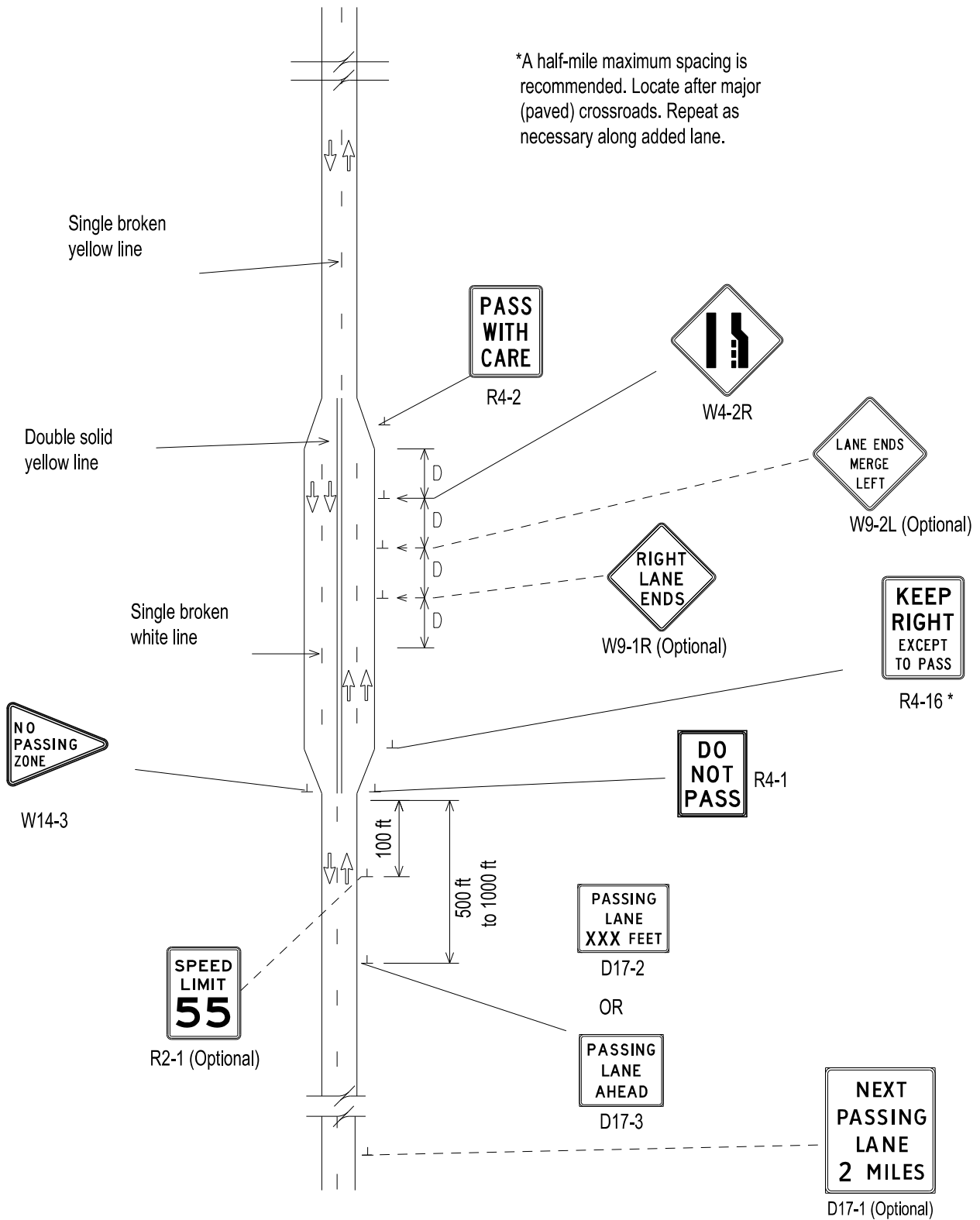

Notes:

1. Opposing direction should use similar signing as required.

2. For the distance D, see Table 3.

		TRAFFIC CONTROL PLAN FOR PASSING LANES	
TRAFFIC AND SAFETY			
DRAWN BY: QHN CHECKED BY: AJU FILE: mdot_tsdpag_appendix_d.dgn	07/19/2022 PLAN DATE:		B-22
			REV.

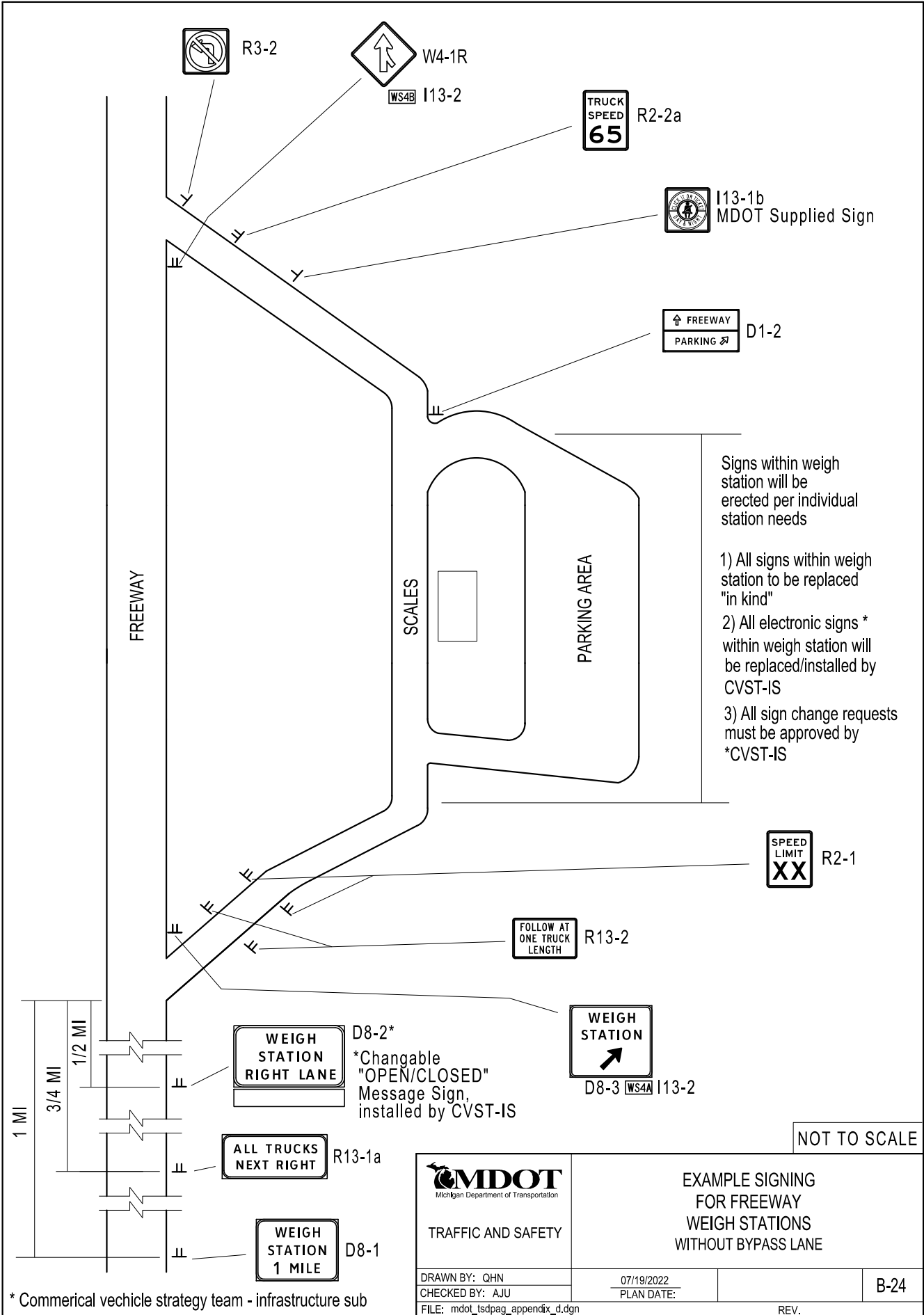

Signs within weigh station will be erected per individual station needs

- 1) All signs within weigh station to be replaced "in kind"
- 2) All electronic signs * within weigh station will be replaced/installed by CVST-IS
- 3) All sign change requests must be approved by *CVST-IS

NOT TO SCALE



TRAFFIC AND SAFETY

EXAMPLE SIGNING FOR FREIGHTWAY WEIGH STATIONS WITHOUT BYPASS LANE

DRAWN BY: QHN

07/19/2022

CHECKED BY: AJU

PLAN DATE:

B-24

FILE: mdot_tsdpag_appendix_d.dgn

REV.

* Commerical vehicle strategy team - infrastructure sub

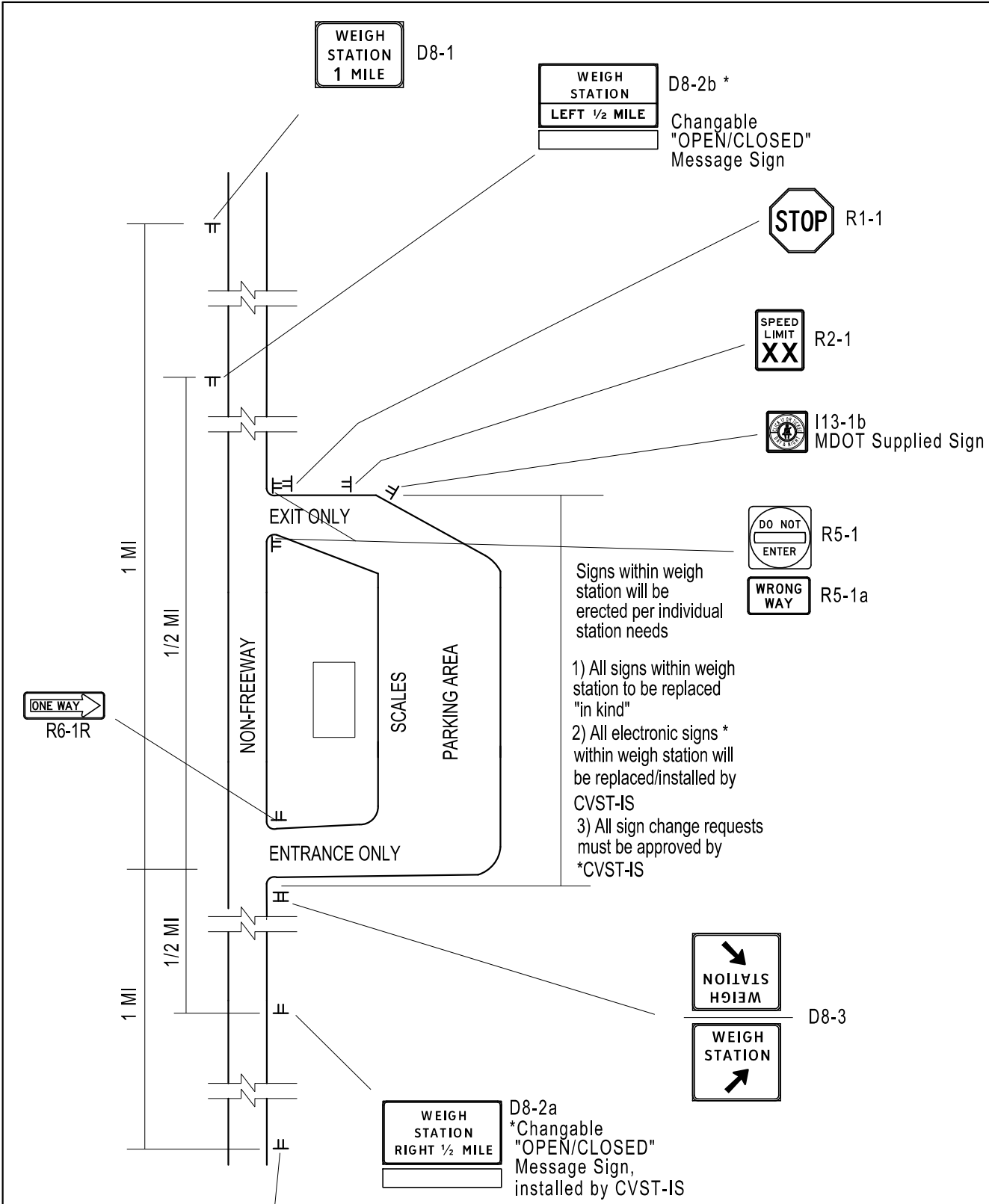

Signs within weigh station will be erected per individual station needs

- 1) All signs within weigh station to be replaced "in kind"
- 2) All electronic signs * within weigh station will be replaced/installed by CVST-IS
- 3) All sign change requests must be approved by *CVST-IS

NOT TO SCALE

	EXAMPLE SIGNING FOR NON-FREEWAY WEIGH STATIONS	
	TRAFFIC AND SAFETY	B-25
DRAWN BY: QHN CHECKED BY: AJU FILE: mdot_tsdpag_appendix_d.dgn	07/19/2022 PLAN DATE:	REV.

* Commerical vechicle strategy team - infrastructure sub

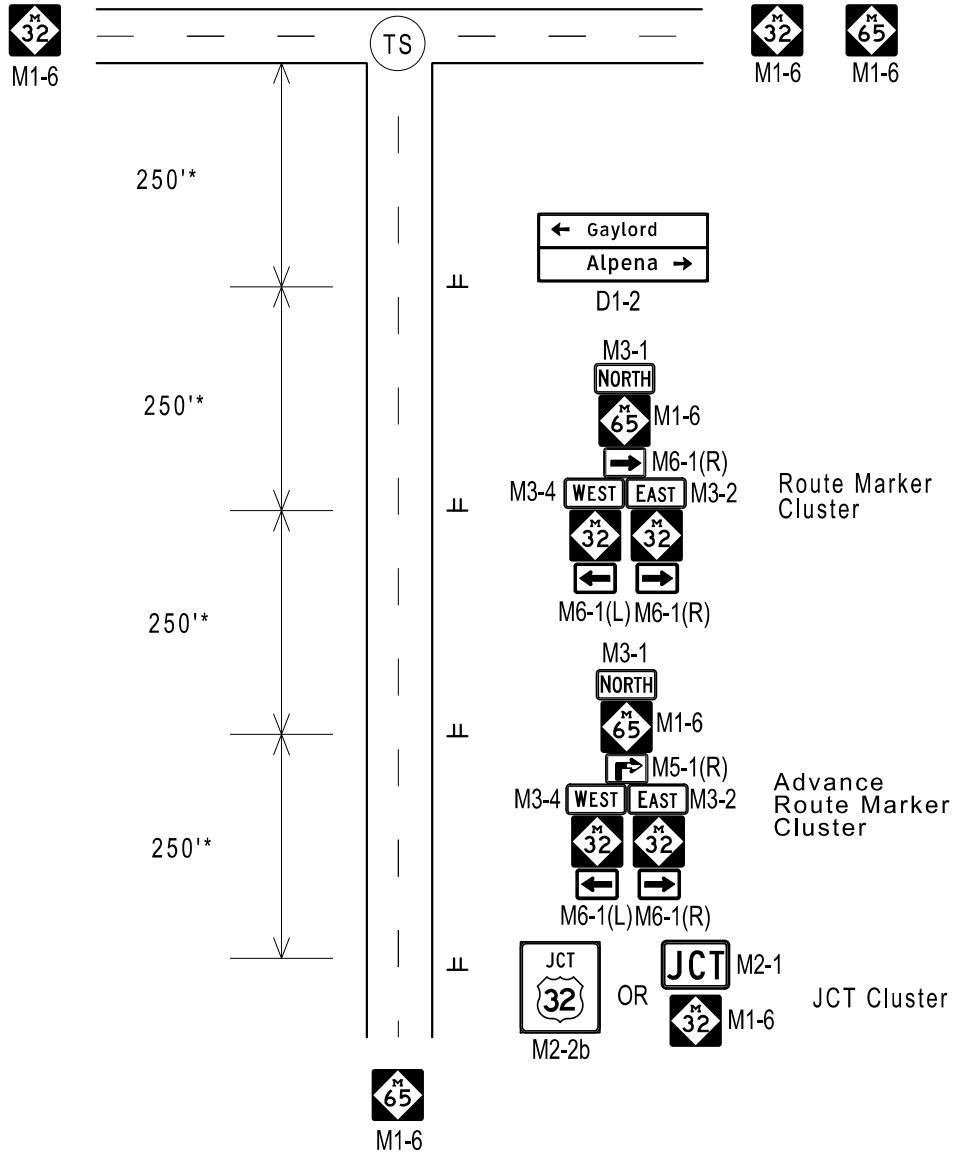

NOT TO SCALE

* Distances vary based on speed



TRAFFIC AND SAFETY

EXAMPLE APPROACH SIGNING
AT JUNCTION OF 2
NON-FREEWAY TRUNKLINES

DRAWN BY: QHN
CHECKED BY: AJU

07/19/2022
PLAN DATE:

B-26

FILE: mdot_tsdpag_appendix_d.dgn

REV.

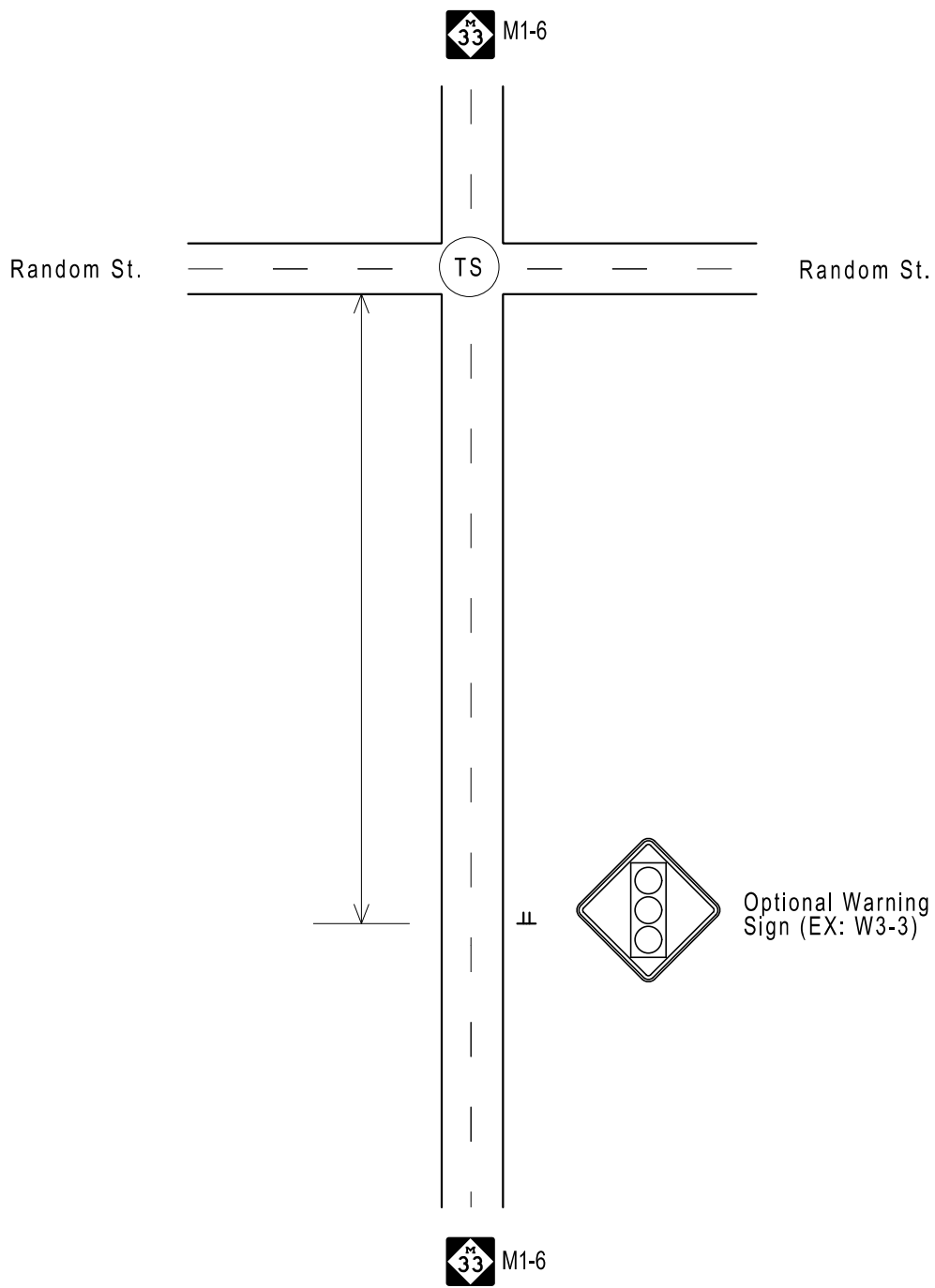

NOT TO SCALE

*Placement of signs may need to be field adjusted based on field conditions.

<p>TRAFFIC AND SAFETY</p>	<p>EXAMPLE APPROACH SIGNING AT INTERSECTION OF NON-FREEWAY TRUNKLINE AND OTHER ROADWAY</p>	
	<p>DRAWN BY: QHN</p> <p>CHECKED BY: AJU</p> <p>FILE: mdot_isdpag_appendix_d.dgn</p>	<p>07/19/2022</p> <p>PLAN DATE:</p>

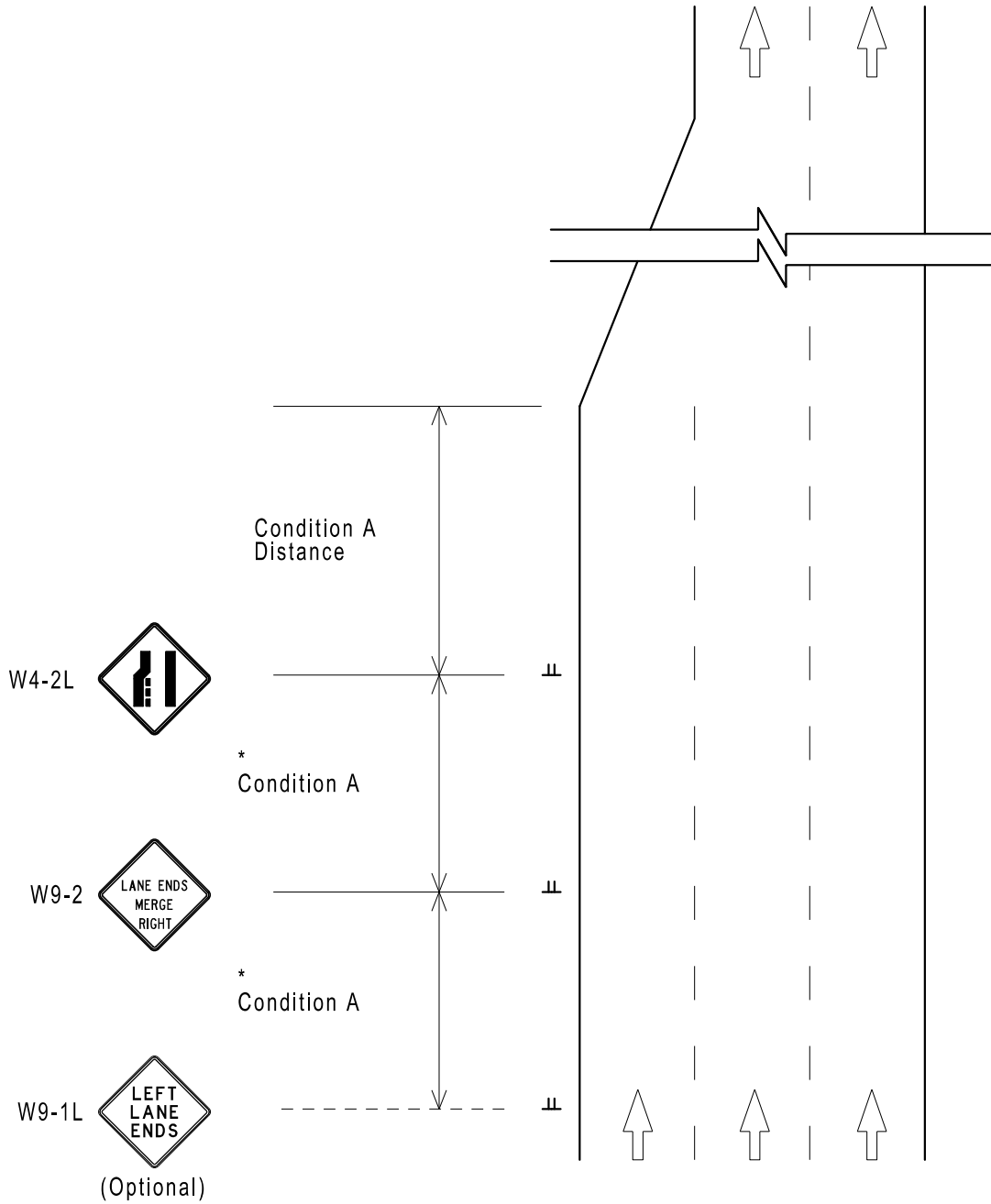

*For situations where you cannot meet Table 3: Condition A, use half of Condition A.

		MINIMUM ADVANCE PLACEMENT DISTANCE FOR SIGNING REQUIRED IN CONDITION A SCENARIO	
DRAWN BY: QHN	07/19/2022	B-28	
CHECKED BY: AJU	PLAN DATE:		
FILE: mdot_tsdpag_appendix_d.dgn		REV.	

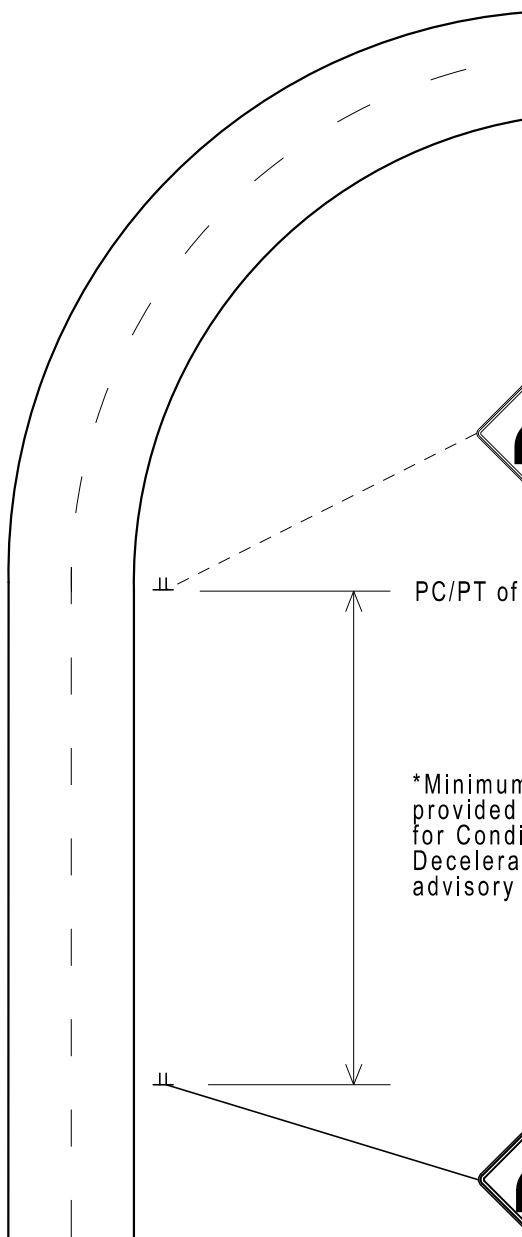

W1-2aR** (Optional)

*Minimum distance provided in Table 3 for Condition B: Decelerate to indicated advisory speed.

W1-2**

W13-1P

**Alternate W1 series signs may be used depending on field conditions.

Note:
Placement of signs may need to be field adjusted based on field conditions.

NOT TO SCALE

 TRAFFIC AND SAFETY	MINIMUM ADVANCE PLACEMENT DISTANCE FOR CURVE SIGNING REQUIRED IN CONDITION B: DECELERATE TO INDICATED ADVISORY SPEED		
	DRAWN BY: QHN CHECKED BY: AJU FILE: mdot_tsdpag_appendix_d.dgn	07/19/2022 PLAN DATE:	REV.

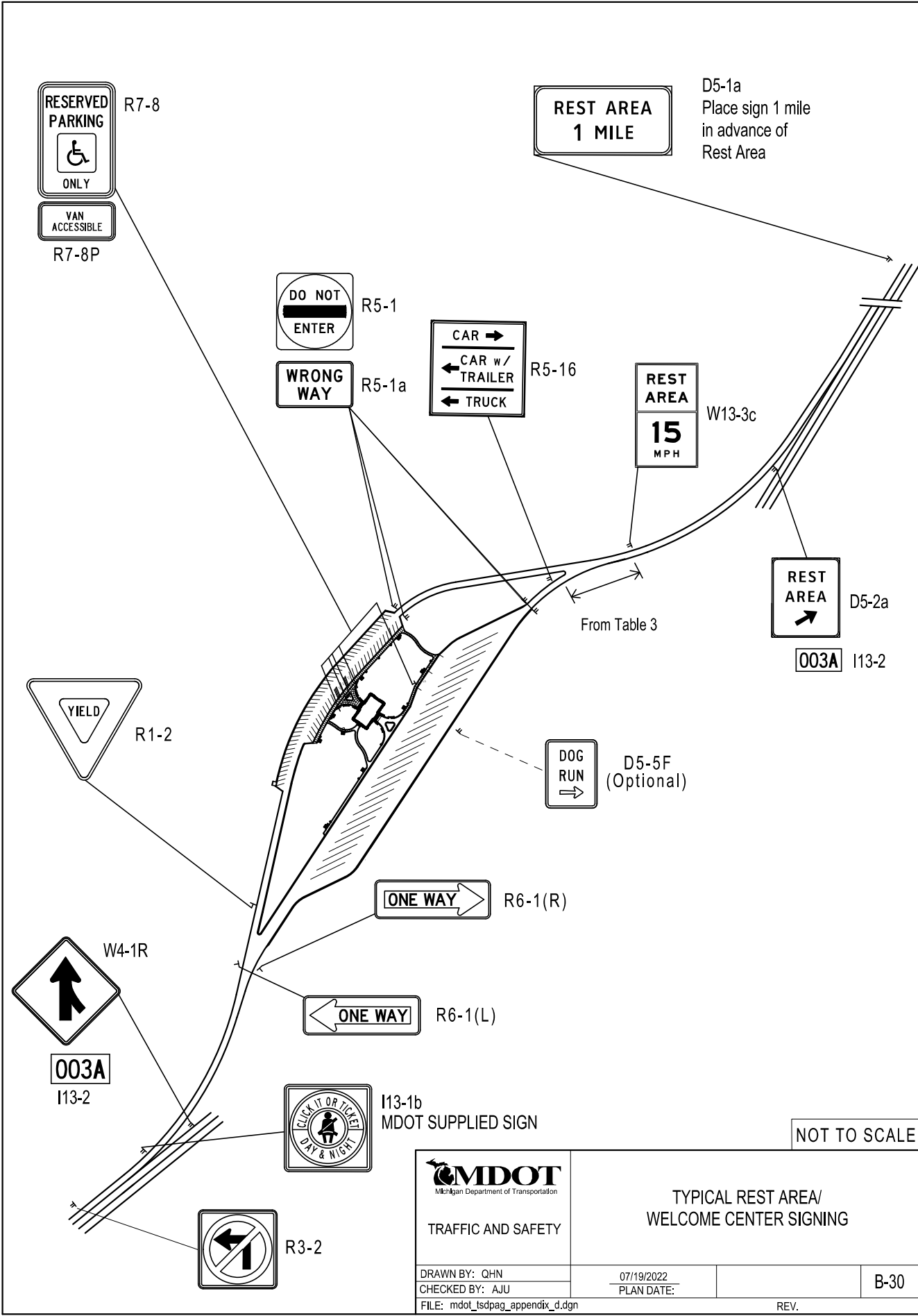

NOT TO SCALE



TRAFFIC AND SAFETY

TYPICAL REST AREA/
WELCOME CENTER SIGNING

DRAWN BY: QHN

07/19/2022

CHECKED BY: AJU

PLAN DATE:

B-30

FILE: mdot_tsdpag_appendix_d.dgn

REV.

APPENDIX C

Arrow-Per-Lane

1 Mile Multi-Lane Exit

Note: Distances are measured from the 2' gore

For freeway to non-freeway interchanges with multi-lane exit :
See MMUTCD figure 2E-11
See MMUCTD figure 2E-12

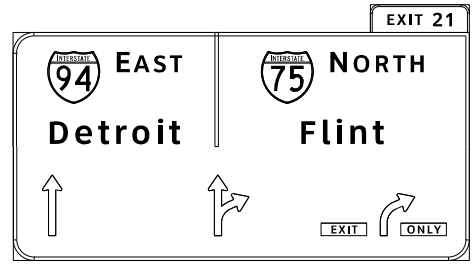
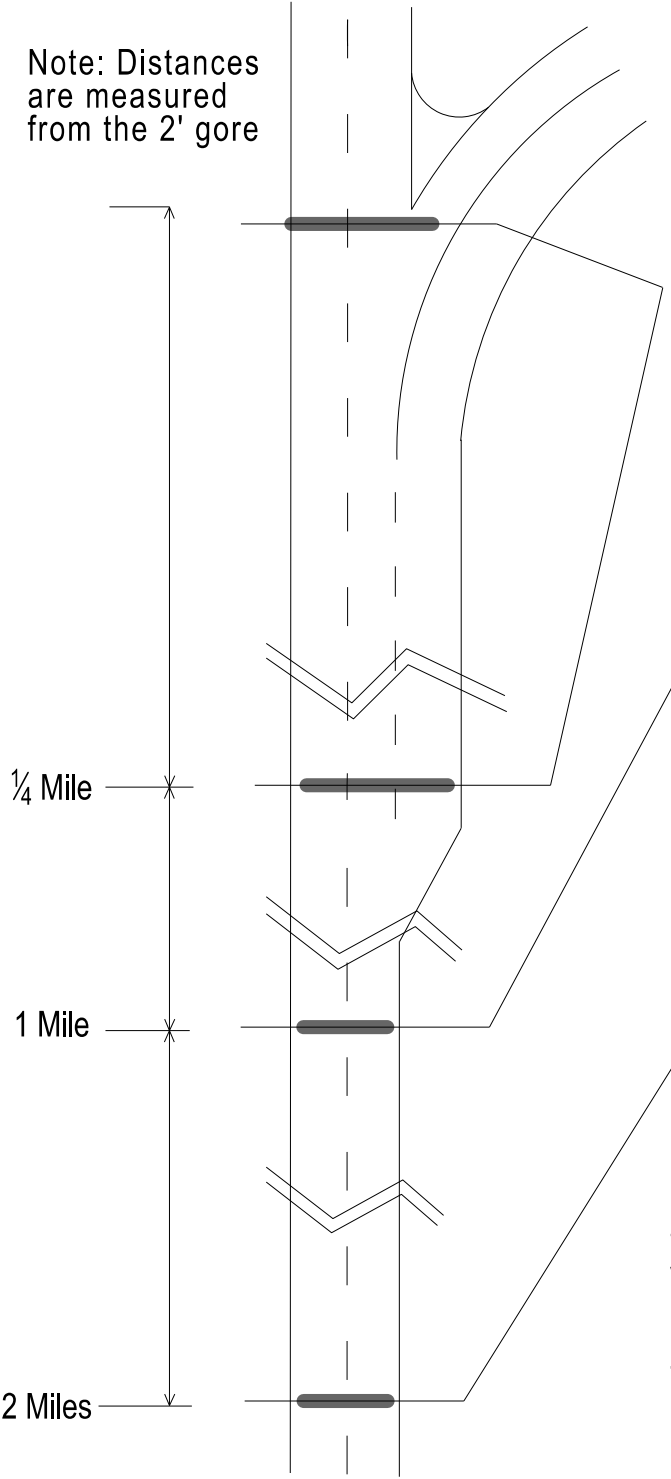

E1-5P

E6-1p

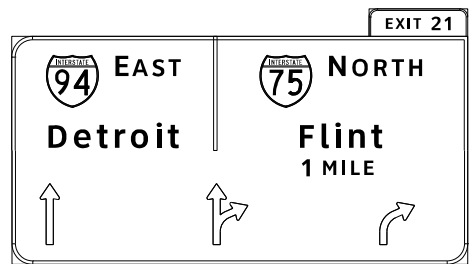

E1-5P

E1-1s

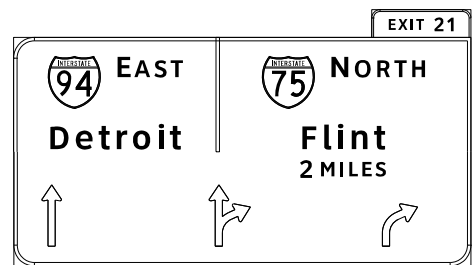

E1-5P

E1-1s

Overhead arrow-per-lane signs are to be used with all major interchanges with other expressways or freeways, high-volume multi-lane highways, principal urban arterials, or major rural routes where the volume of interchanging traffic is heavy or includes many road users unfamiliar with the area.

Note: Use sign at 2 mile point for major interchanges as spacing allows.

<p>TRAFFIC AND SAFETY</p>	<p>Case 1 Multi-Lane Exits with an Option Lane</p>	
	<p>DRAWN BY: QHN CHECKED BY: AJU FILE: mdot_+sdpag_appendix_d.dgn</p>	<p>04/21/2022 PLAN DATE: REV.</p>

Less Than 1/2 Mile Exit Lane

Note: Distances are measured from the 2' gore

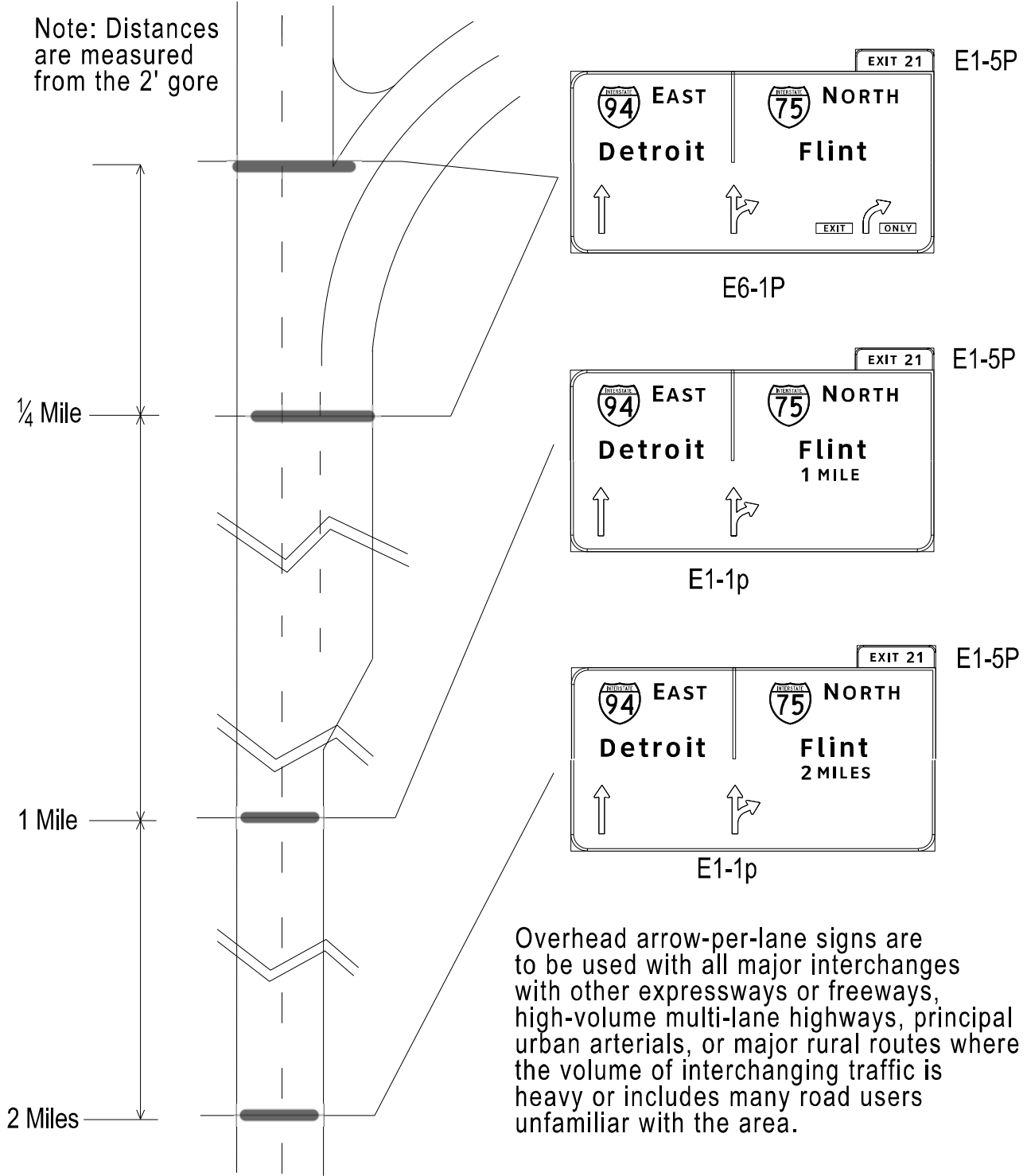

Overhead arrow-per-lane signs are to be used with all major interchanges with other expressways or freeways, high-volume multi-lane highways, principal urban arterials, or major rural routes where the volume of interchanging traffic is heavy or includes many road users unfamiliar with the area.

Note: Use sign at 2 mile point for major interchanges as spacing allows.

<p>TRAFFIC AND SAFETY</p>	<p>Case 2 Multi-Lane Exits with an Option Lane</p>		<p>C-3</p>
	<p>DRAWN BY: QHN CHECKED BY: AJU</p>	<p>04/21/2022 PLAN DATE:</p>	
<p>FILE: mdot_tsdpag_appendix_d.dgn</p>			

Dual Exit Destinations With an Option Lane

Note: Distances are measured from the 2' gore

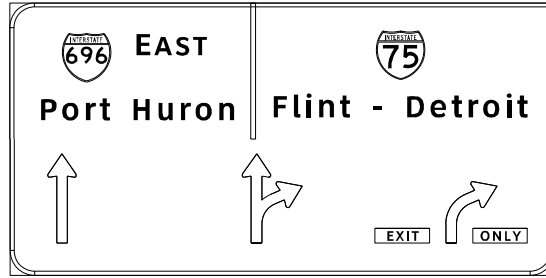
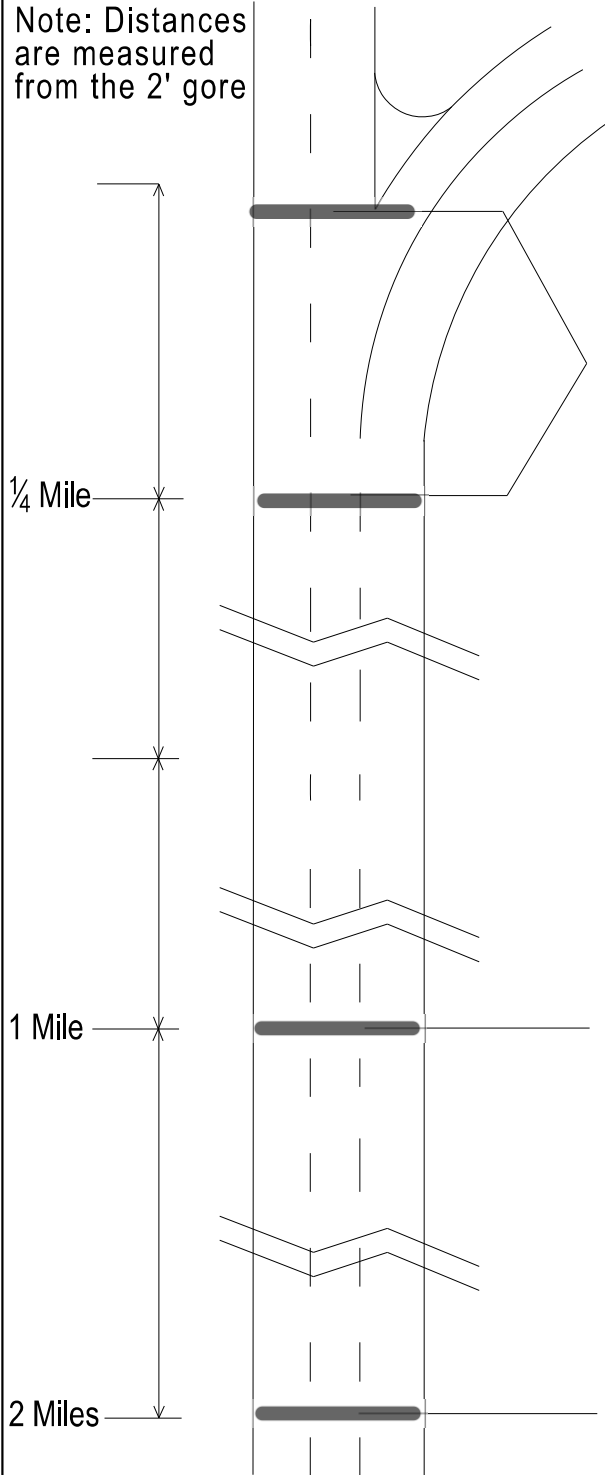

E6-1q

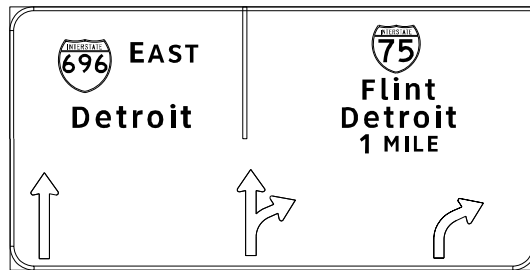

E1-1t

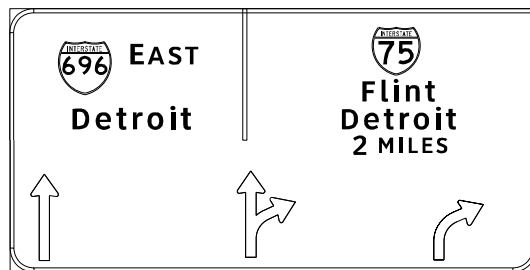

E1-1t

Note: Use sign at 2 mile point for major interchanges as spacing allows.

Multiple exit destinations will show both destinations but will not be split by destination until the 0.5 mile location.



TRAFFIC AND SAFETY

Case 3
Multi-Lane Exits with
an Option Lane

DRAWN BY: QHN

CHECKED BY: AJU

FILE: mdot_tsdpag_appendix_d.dgn

04/21/2022

PLAN DATE:

REV.

C-4

Gore Truss Location

Note: Distances are measured from the 2' gore

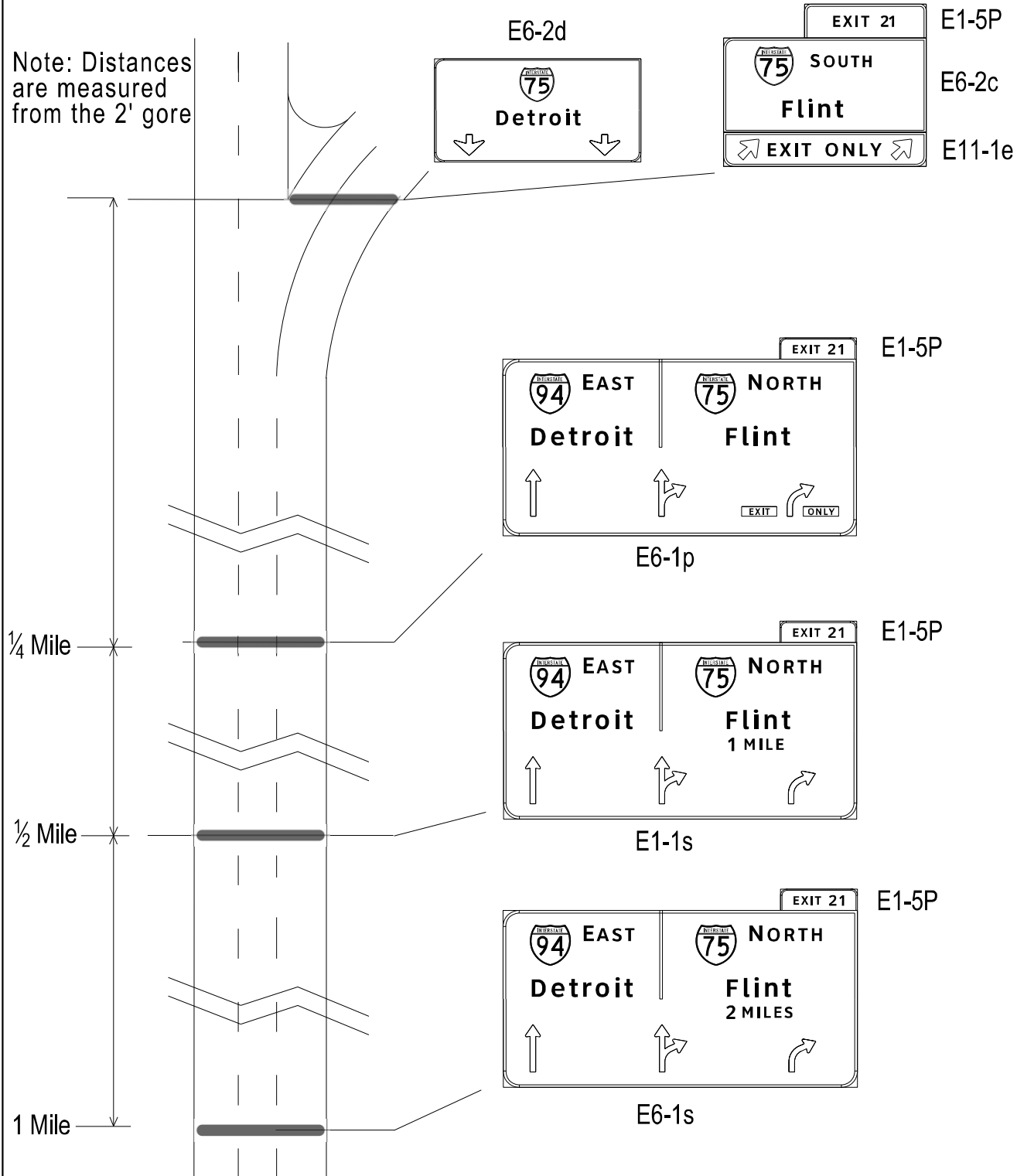

Note: Use sign at 2 mile point for major interchanges as spacing allows.
Arrow-per-lane sign omitted if gore location is used.

<p>TRAFFIC AND SAFETY</p>	<p>Case 4 Multi-Lane Exits with an Option Lane</p>	
	<p>DRAWN BY: QHN CHECKED BY: AJU</p>	<p>04/21/2022 PLAN DATE:</p>
<p>FILE: mdot_+sdpag_appendix_d.dgn</p>		<p>REV.</p>

Truss Type E (Right Upright Shown)

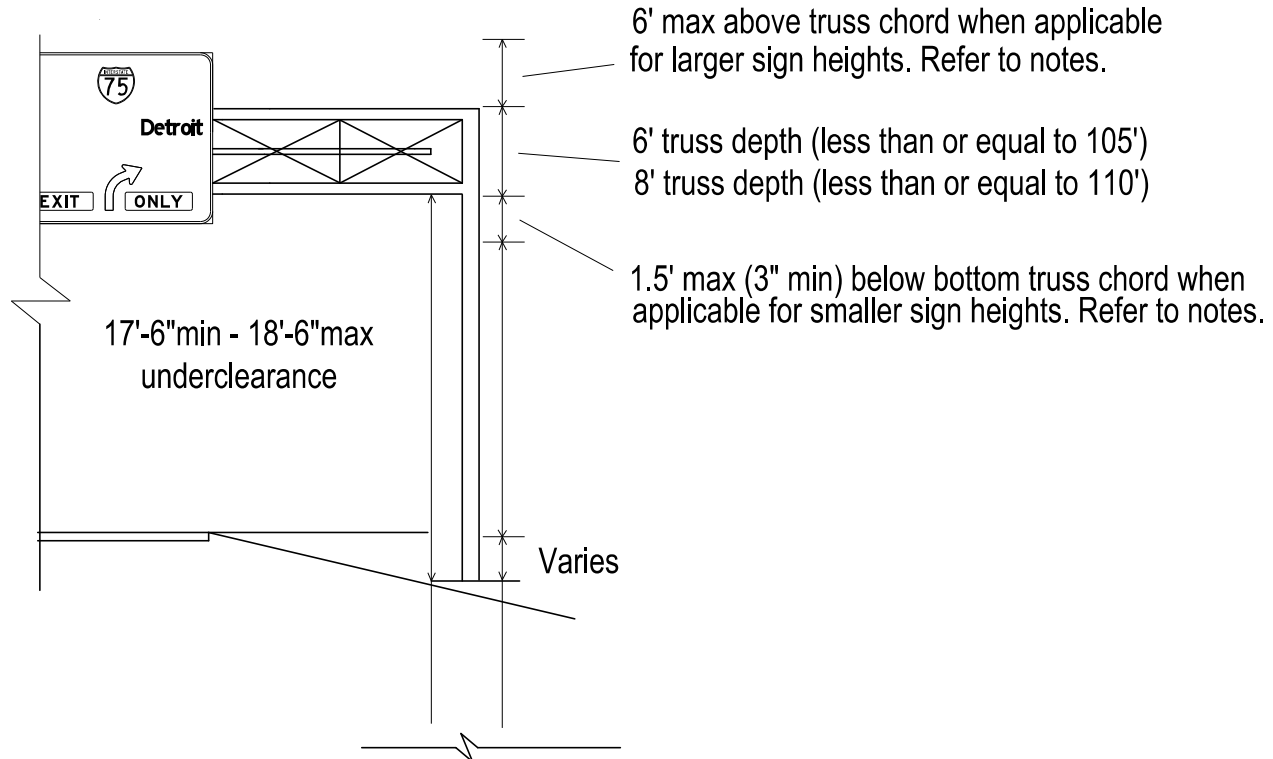

NOTES:

1. For 6' truss depth
 - < 13' : 3" maximum below bottom truss chord
 - ≥ 13' : center the sign on the truss box
2. For 8' truss depth
 - < 15' Sign height: 3" maximum below truss chord
 - ≥ 15' Sign: center the sign on the truss box
3. Maximum end support column height is 26'-3". Refer to Standard Sign-360 series for additional notes.
4. Minimum sign height is 1' larger than the specified truss depth
5. The minimum underclearance of 17'-6" is from the roadway lane elevation high point
6. Where a drilled shaft foundation is called for on a foreslope steeper than 1:4, add fill as directed by the engineer.
7. Where guardrail is called for in the plans, all notes apply unless as otherwise directed by the engineer.
8. The panel I sign design should be used in all cases. Panel II is only to be used when the field conditions do not allow for the panel I sign.



TRAFFIC AND SAFETY

Truss Elevation
Type E

DRAWN BY: QHN

CHECKED BY: AJU

FILE:

04/21/2022
PLAN DATE:

C-6

REV. 01/13/2020

APPENDIX D
Roundabout Signing Guidelines

Appendix D

Roundabout Signing Guidelines

INFORMATION: The following describes the signing used at example roundabouts and provides information about each sign in regard to when and where each sign can be used.

This document was formed using elements from the NCHRP Report 672 *Roundabouts: An Informational Guide*, the FHWA Roundabout Guide Chapter 7.1, and the 2011 Michigan Manual for Uniform Traffic Control Devices (MMUTCD).

Sizes of these signs shall match the required size per the current version of the MMUTCD and the Traffic Sign Design, Placement, and Application Guidelines (TSDPAG). Sign supports shall follow the standard sign support details in the TSDPAG. Any roundabout sign detail shall not combine any elements outside of the primary classification (i.e.: green and white guide signs shall not contain warning sign elements).

The following paragraphs describe each sign. All referenced figures refer to the figures within this document.

Signs on Roundabout Approaches:

- W2-6 (Circular Intersection Sign) – This sign shall be required to be the first sign on the approach of a roundabout. The sign may be clustered with the appropriate advisory speed (W13-1).
 - o For tear-drop roundabouts, the W2-6 sign shall be replaced with a W6-1 sign.
- A guide sign shall be required to be the second sign on the approach to a roundabout. This sign will give destination information so the driver can decide what turn movement is required. The D1-2d series and the D1-3d series shall be used to provide the driver direction on what direction to turn. Freeway off-ramp applications shall use the D1-5 sign or a variation of that sign.
- A regulatory lane-use control sign shall be the third sign on the approach to a roundabout if there are multiple approach lanes that continue into the roundabout. If the roundabout has a single lane approach, a lane-use control sign is not necessary. Sign details R3-8an-R, R3-8ao-R, R3-8ap-R, and R3-8aq-R are examples of the lane-use control signs.
- Route Marker Clusters – These signs should be used in advance of the roundabout after the W2-6, Guide Sign, and (if any exists) lane-use control sign.
- W3-2 (Yield Ahead Sign) – These signs shall not be used in normal circumstances. The W3-2 shall only be used when the sight distance of the yield sign is severely limited.
- Movement prohibition signs (R3-1, 2, 3, and 4) are prohibited within and approaching roundabouts.

- R1-2 (Yield Sign) – All roundabouts shall be required to have a yield sign placed on the right-hand side of the entry into a roundabout. A yield sign may be placed on the left-hand side of the roundabout if desired.
- W11-2 (Pedestrian Crossing Signs) – Pedestrian crossing signs are only required on roundabouts with established pedestrian crossings. For all roundabout approaches with pedestrian crossings, the W11-2 shall be placed on the right-hand side of the road, placed just beyond the pedestrian crossing. For roundabouts with multiple approach lanes and pedestrian crossings, a W11-2 shall be placed on both the left-hand side and the right-hand side of the roadway just beyond the pedestrian crossing.
 - o If used, the W11-2 shall be combined with the diagonal arrow plaque, W16-7P (L or R).

Signs within Roundabouts:

- R6-4a, 4b (Roundabout Directional Arrow Sign(s)) – The central island of a roundabout shall have one roundabout directional arrow sign per approach. These signs shall be placed in the central island of the roundabout in target position of the approach lanes and shall be mounted with 4-foot bottom height. The R6-4a sign shall be used on single lane roundabouts and the R6-4b shall be used on roundabouts with multi-lane approaches.
- Street name “exit” signs shall be placed in the splitter island at the exit of a roundabout. These signs shall be one of five options:
 - I) Route marker cluster with M6-2 as the arrow
 - II) D1-1b – Legend only
 - III) D1-1c – Legend only
 - IV) D1-1d – Legend and route marker in the same sign

Signs Leaving Roundabouts:

- After exiting a roundabout on a state trunkline highway, a confirmatory route marker cluster shall be erected within 200’ from the edge of circulating traffic.
 - o If the roundabout lies at a junction of two state trunklines, typical junction signing shall be followed (Route, Speed, Distance). Speed and distance signs are optional if the roundabout is not at a junction.
- W11-2 (Pedestrian Crossing Sign) – Roundabout exits with an established pedestrian crossing shall have a W11-2 sign placed on the right-hand side of the road just beyond the pedestrian crossing. If there are multiple lanes exiting from the roundabout with an established pedestrian crossing, the W11-2 sign shall be placed on both the left-hand and right-hand side of the road just beyond the pedestrian crossing.
 - o If used, the W11-2 shall be combined with the diagonal arrow plaque, W16-7P (L or R).

- W4-2R (Lane Ends Sign) - If lanes exiting a roundabout merge, a lane ends sign shall be placed at the beginning of the lane taper.

Signs on Freeway Off-Ramps:

- All previous signing principles shall be followed for roundabouts at freeway interchanges. The freeway off-ramps shall be treated as a roundabout approach.
- Overhead signing may be used for roundabouts on freeway off-ramps or for locations with special circumstances. All other signing options shall be considered prior to placing signs overhead. Overhead signing shall be avoided if possible. Only guide sign information or regulatory lane-control signs may be placed on overhead structures, but they shall not be placed on the same structure.

Signs for Right-Turn Bypass Lanes:

- The roundabout approach shall contain the circular intersection cluster and a guide sign.
- The regulatory lane-use control sign shall incorporate a normal right turn only arrow while maintaining the appropriate roundabout arrows for all other lanes.
- The route marker cluster should be used in advance of the bypass lane after the W2-6, Guide Sign, and lane-use control sign.
- W12-1 (Double Arrow Sign) – Shall be placed at the nose of the island splitting the bypass lane from the through lanes.
- W11-2 (Pedestrian Crossing Sign) – Roundabout bypass lanes with an established pedestrian crossing shall have a W11-2 sign placed on the right-hand side of the road just beyond the pedestrian crossing. If there are multiple bypass lanes exiting from the roundabout with an established pedestrian crossing, the W11-2 sign shall be placed on both the left-hand and right-hand side of the road just beyond the pedestrian crossing.
 - o If used, the W11-2 shall be combined with the diagonal arrow plaque, W16-7P (L or R).
- W4-1 (Merge Sign) – The merge sign shall be placed at the far end of the splitter island where the bypass lane merges with the “exiting” lane.
- W4-2R (Lane Ends Sign) – The lane ends sign shall be placed at the beginning of the lane taper where the bypass lane merges with the “exiting” lane.

The signs shown in page D-6 through D-10 at the end of this document show the preferred sign layout for the entrance, interior, and exit of a roundabout, roundabouts on freeway off-ramps, and roundabouts with a right-turn bypass lane. If proper sign spacing proper is not achievable then sign spacing may be reduced to a minimum of 150 feet (for roundabout signing only).

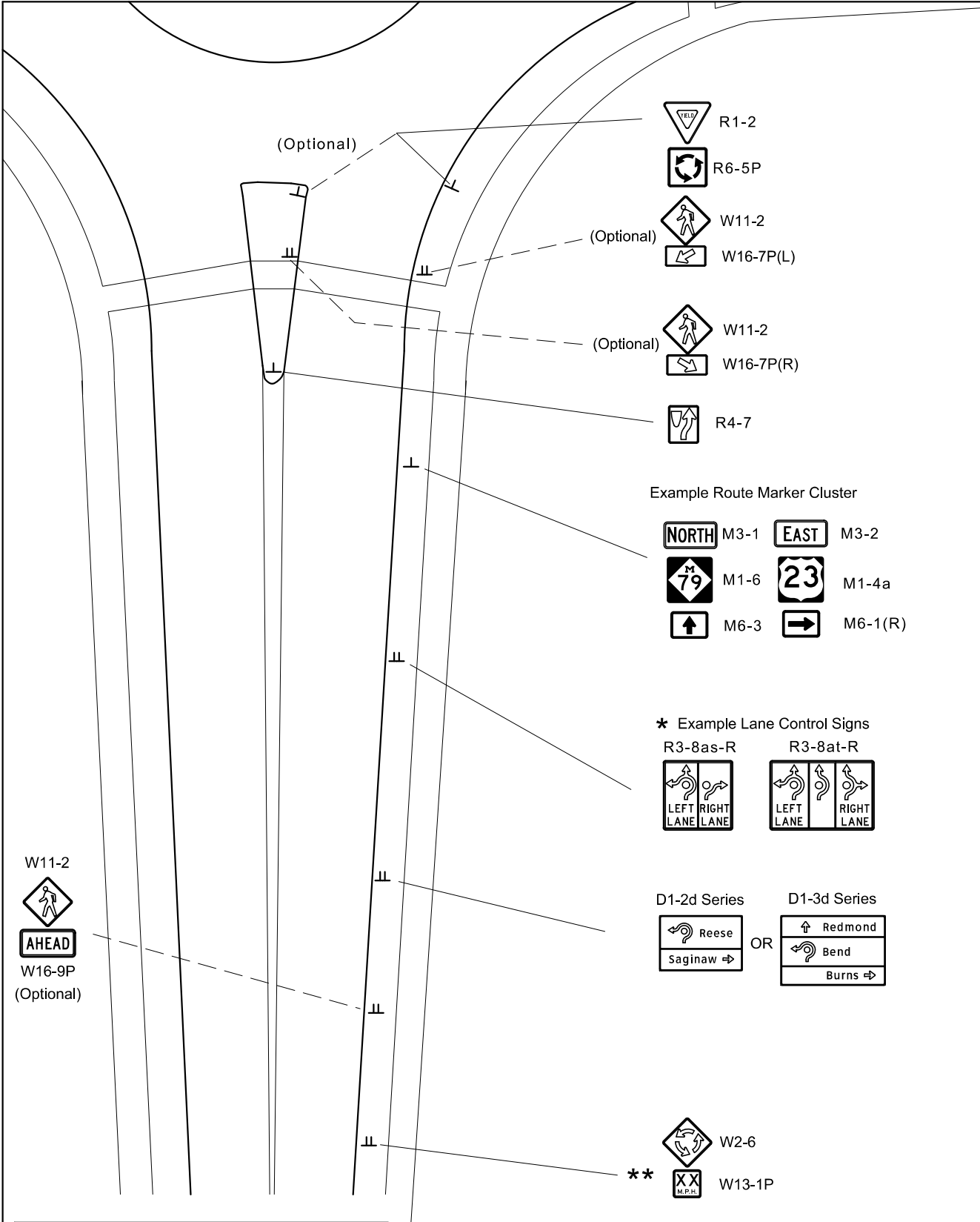



* Only use for multi-lane approach.

** W2-6, W13-1P combination required on approaches equal to or greater than 40mph and also within freeway interchanges.



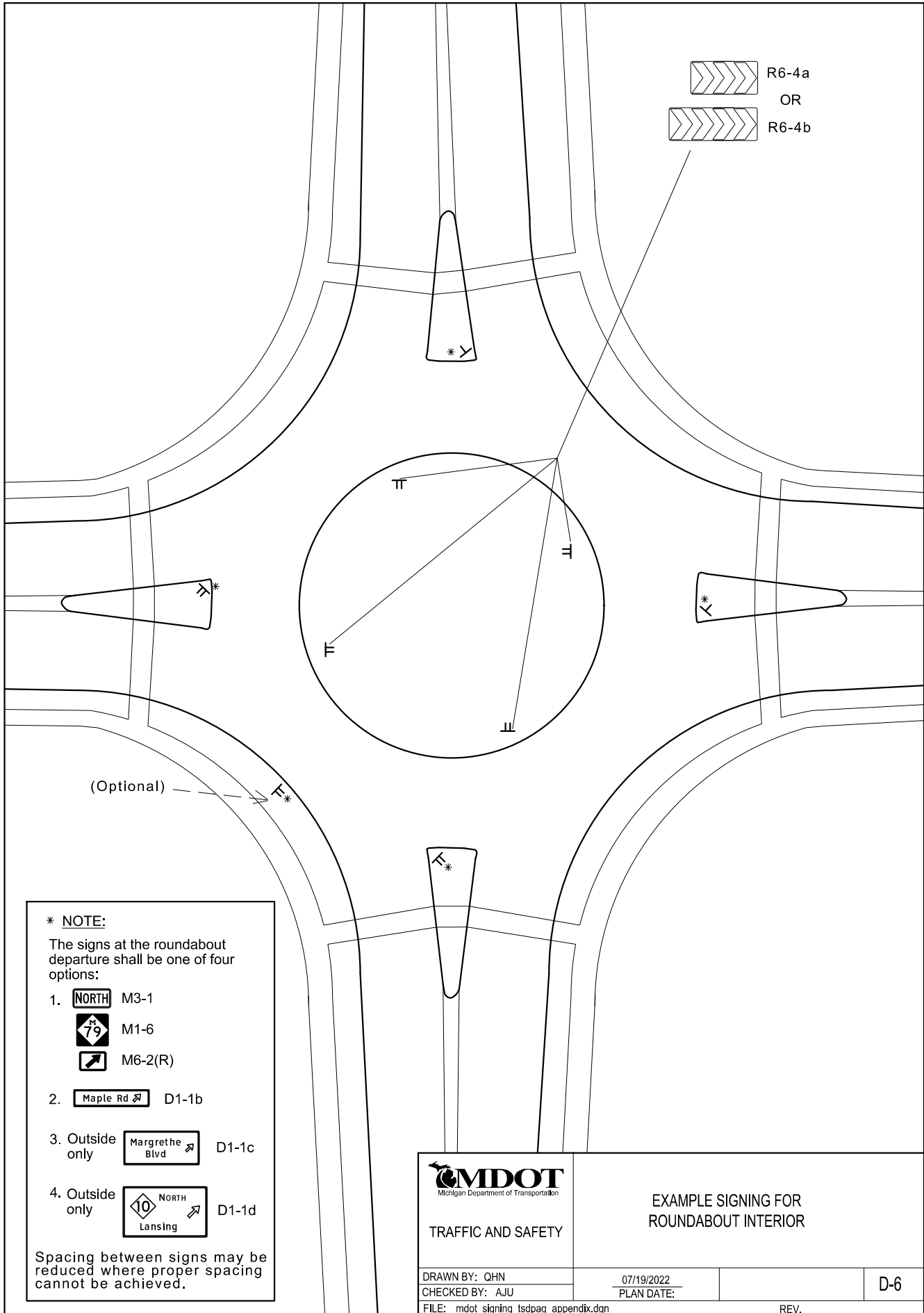



Spacing between signs may be reduced where proper spacing cannot be achieved.

<p>MDOT Michigan Department of Transportation</p>	<p>EXAMPLE SIGNING FOR ROUNDBOUT APPROACH</p>	
	<p>TRAFFIC AND SAFETY</p>	
<p>DRAWN BY: QHN CHECKED BY: AJU</p>	<p>07/19/2022 PLAN DATE:</p>	<p>D-5</p>
<p>FILE: mdot_signing_tsdpag_appendix.dgn</p>		<p>REV.</p>

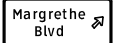

 R6-4a
 OR
 R6-4b

*** NOTE:**
 The signs at the roundabout departure shall be one of four options:

-  M3-1
 M1-6
 M6-2(R)
-  D1-1b
- Outside only  D1-1c
- Outside only  D1-1d

Spacing between signs may be reduced where proper spacing cannot be achieved.

		EXAMPLE SIGNING FOR ROUNDABOUT INTERIOR	
TRAFFIC AND SAFETY			
DRAWN BY: QHN CHECKED BY: AJU	07/19/2022 PLAN DATE:		D-6
FILE: mdot_signing_tsdpag_appendix.dgn		REV.	

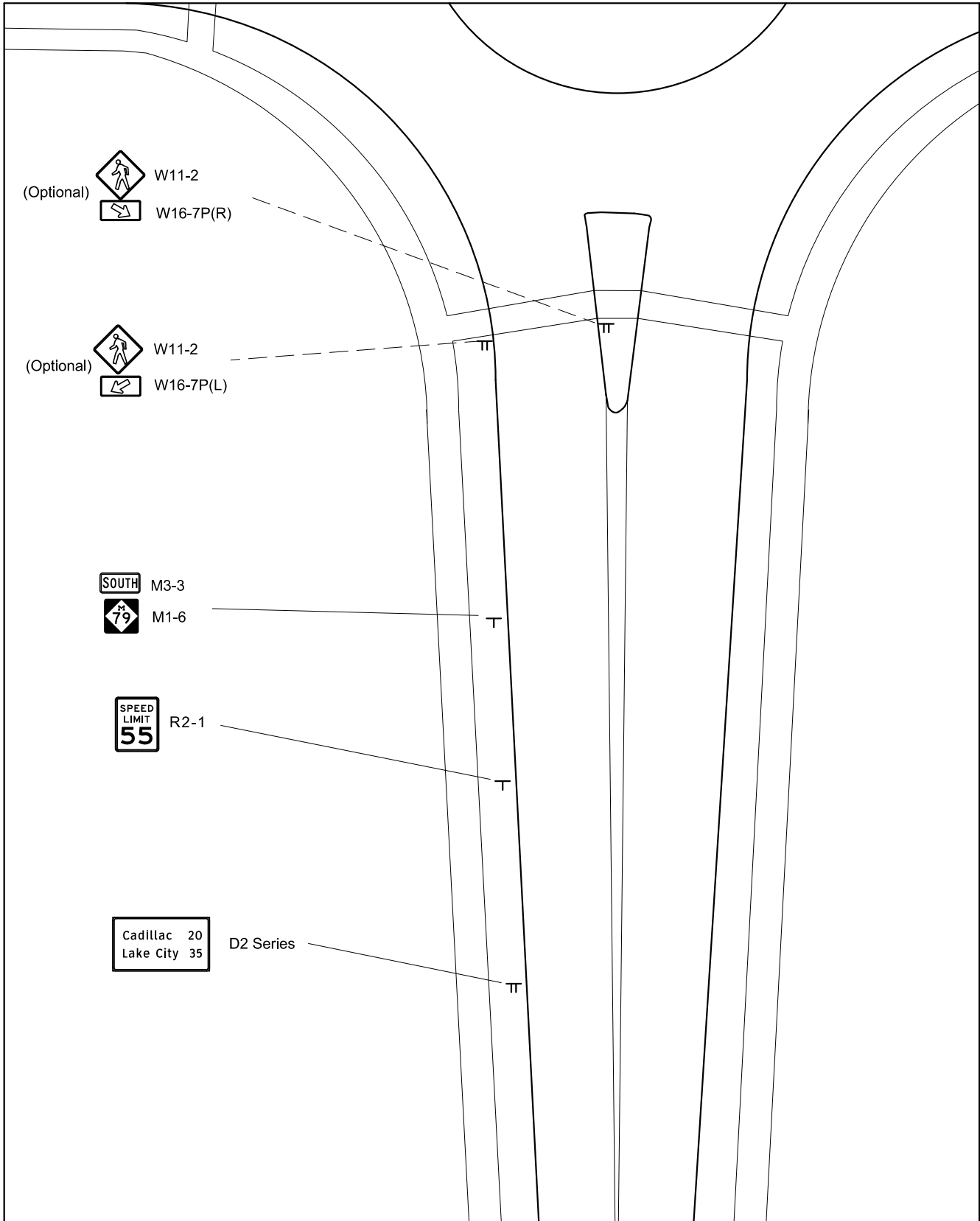

Spacing between signs may be reduced where proper spacing cannot be achieved.



TRAFFIC AND SAFETY

EXAMPLE SIGNING AT
ROUNDBOUT DEPARTURE

DRAWN BY: QHN
CHECKED BY: AJU

07/19/2022
PLAN DATE:

D-7

FILE: mdot_signing_tsdpag_appendix.dgn

REV.

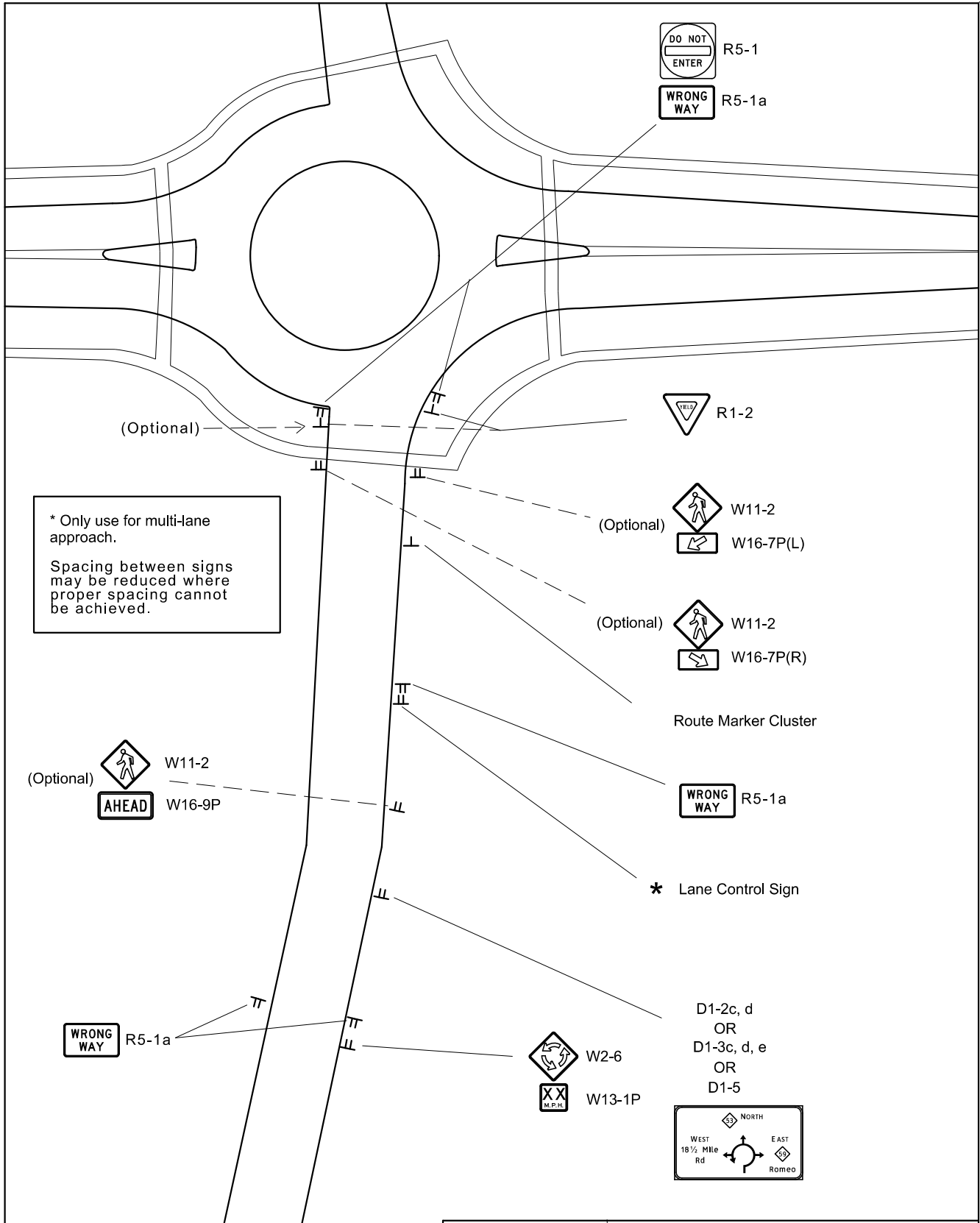

<p>TRAFFIC AND SAFETY</p>	<p>EXAMPLE SIGNING FOR A ROUNDABOUT AT A FREEWAY INTERCHANGE</p>		<p>D-8</p>
	<p>DRAWN BY: QHN CHECKED BY: AJU</p>	<p>07/19/2022 PLAN DATE:</p>	
<p>FILE: mdot_signing_lsdpag_appendix.dgn</p>			

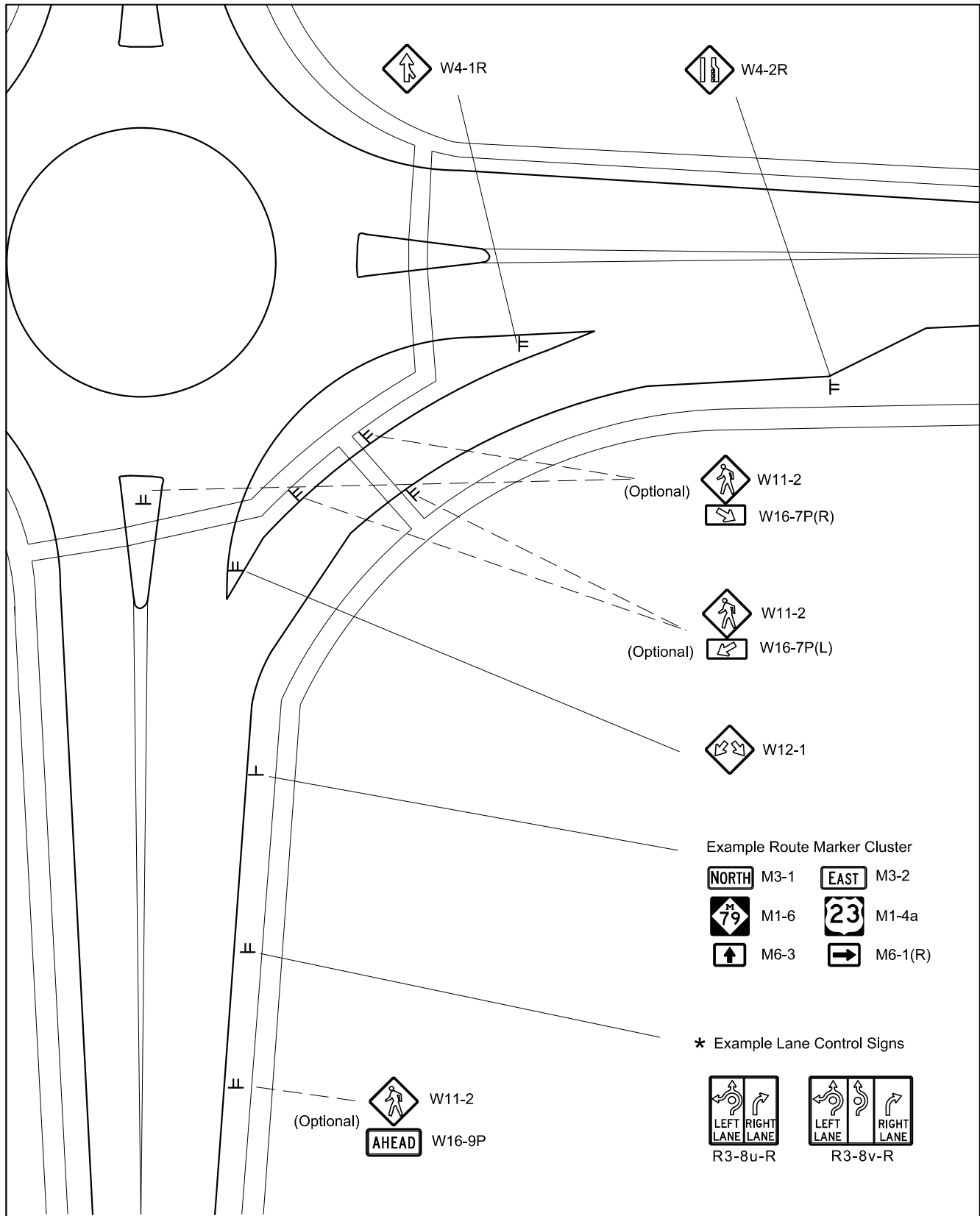

* Only use for multi-lane approach.
 Spacing between signs may be reduced where proper spacing cannot be achieved.
 Use all prior signing for Roundabout Approach, page D-1.

		EXAMPLE SIGNING FOR ROUNDABOUT WITH RIGHT-TURN BYPASS LANE	
TRAFFIC AND SAFETY			
DRAWN BY: QHN CHECKED BY: AJU	07/19/2022 PLAN DATE:		D-9
FILE: mdot_signing_tsdpag_appendix.dgn		REV.	

APPENDIX E
Incident Management Route Signing

EMERGENCY CLOSURE PLAN TYPICAL SIGN LAYOUT

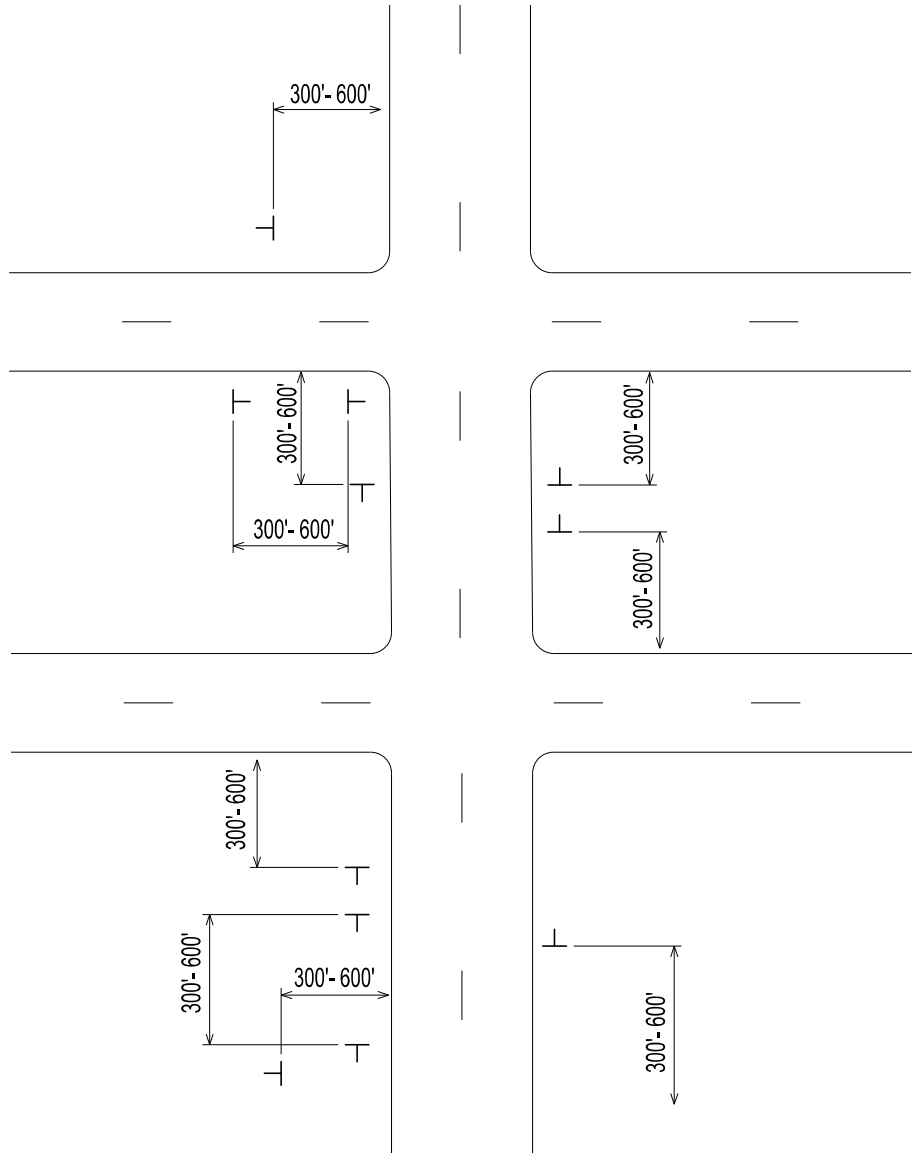
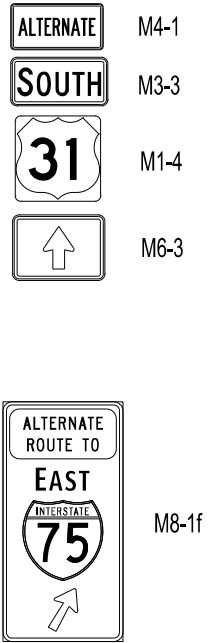

Typical sign layout turns, and throughs for emergency closure plans based on speed limit & nearest crossroad.

NOT TO SCALE

<p>TRAFFIC AND SAFETY</p>	<p>INCIDENT MANAGEMENT ROUTE SIGNING</p>	
	<p>DRAWN BY: QHN CHECKED BY: AJU FILE:</p>	<p>07/19/2022 PLAN DATE:</p>

REV. 02/21/2021

EMERGENCY FREEWAY CLOSURE PLAN EXAMPLE

SEGMENT #34

I-94 FREEWAY

CLOSED BETWEEN M-66/I-94(Exit 98) AND BEADLE LAKE(Exit 100)

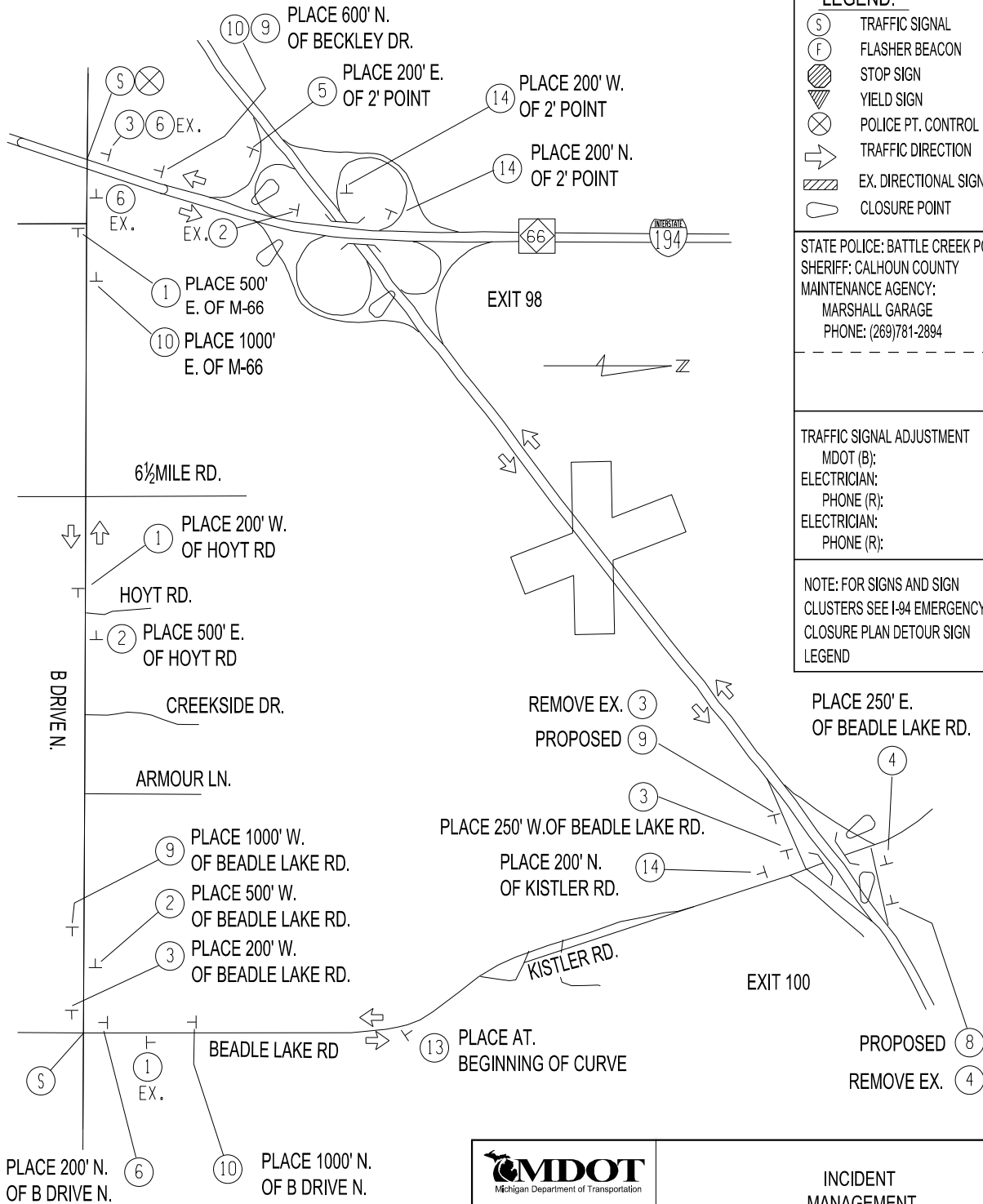

LEGEND:

- (S) TRAFFIC SIGNAL
- (F) FLASHER BEACON
- (X) STOP SIGN
- (Y) YIELD SIGN
- (P) POLICE PT. CONTROL
- (T) TRAFFIC DIRECTION
- (D) EX. DIRECTIONAL SIGN
- (C) CLOSURE POINT

STATE POLICE: BATTLE CREEK POST
 SHERIFF: CALHOUN COUNTY
 MAINTENANCE AGENCY:
 MARSHALL GARAGE
 PHONE: (269)781-2894

TRAFFIC SIGNAL ADJUSTMENT
 MDOT (B);
 ELECTRICIAN:
 PHONE (R);
 ELECTRICIAN:
 PHONE (R);

NOTE: FOR SIGNS AND SIGN CLUSTERS SEE I-94 EMERGENCY CLOSURE PLAN DETOUR SIGN LEGEND

PLACE 200' N. OF B DRIVE N. (6)

PLACE 1000' N. OF B DRIVE N. (10)













NOT TO SCALE

<p>TRAFFIC AND SAFETY</p>	<p>INCIDENT MANAGEMENT ROUTE SIGNING</p>	
	<p>DRAWN BY: QHN</p> <p>CHECKED BY: AJU</p> <p>FILE:</p>	<p>07/19/2022</p> <p>PLAN DATE:</p>

REV. 02/21/2021

I-94 EMERGENCY CLOSURE PLAN DETOUR SIGN LEGEND EXAMPLE

SIGN LEGEND

	M4-1
	M4-4
	M3-2a
	M3-4a
	M1-1
	M6-3a
	M6-1a (L)
	M6-1a
	M5-1a
	M5-1a (R)
	M5-2a
	M5-2a (R)

SIGN CLUSTER LEGEND (CARS)

①	②	③	④	⑤	⑥	⑦	⑧	⑨	⑩	⑪	⑫	⑬	⑭
EMERGENCY	EMERGENCY	EMERGENCY	EMERGENCY	EMERGENCY	EMERGENCY	EMERGENCY	EMERGENCY	EMERGENCY	EMERGENCY	EMERGENCY	EMERGENCY	EMERGENCY	EMERGENCY
EAST	WEST	EAST	WEST	EAST	WEST	EAST	WEST	EAST	WEST	EAST	WEST	EAST	WEST
INTERSTATE 94	INTERSTATE 94	INTERSTATE 94	INTERSTATE 94	INTERSTATE 94	INTERSTATE 94	INTERSTATE 94	INTERSTATE 94	INTERSTATE 94	INTERSTATE 94	INTERSTATE 94	INTERSTATE 94	INTERSTATE 94	INTERSTATE 94
↑	↑	←	←	→	→	↗	↖	↖	↗	↗	↖	↖	↗

SIGN CLUSTER LEGEND (TRUCKS)

⑮	⑯	⑰	⑱	⑲	⑳	㉑	㉒	㉓	㉔	㉕	㉖	㉗	㉘
EMERGENCY	EMERGENCY	EMERGENCY	EMERGENCY	EMERGENCY	EMERGENCY	EMERGENCY	EMERGENCY	EMERGENCY	EMERGENCY	EMERGENCY	EMERGENCY	EMERGENCY	EMERGENCY
TRUCK	TRUCK	TRUCK	TRUCK	TRUCK	TRUCK	TRUCK	TRUCK	TRUCK	TRUCK	TRUCK	TRUCK	TRUCK	TRUCK
EAST	WEST	EAST	WEST	EAST	WEST	EAST	WEST	EAST	WEST	EAST	WEST	EAST	WEST
INTERSTATE 94	INTERSTATE 94	INTERSTATE 94	INTERSTATE 94	INTERSTATE 94	INTERSTATE 94	INTERSTATE 94	INTERSTATE 94	INTERSTATE 94	INTERSTATE 94	INTERSTATE 94	INTERSTATE 94	INTERSTATE 94	INTERSTATE 94
↑	↑	←	←	→	→	↗	↖	↖	↗	↗	↖	↖	↗



TRAFFIC AND SAFETY

INCIDENT
MANAGEMENT
ROUTE SIGNING

NOT TO SCALE

DRAWN BY: QHN
CHECKED BY: AJU
FILE:

07/19/2022
PLAN DATE:

REV.

E-4