

Price

PCC PAVEMENT JOINT RESTORATION
AND REHABILITATION
(Federal Highway Administration NEEP Project 27)
Construction Report

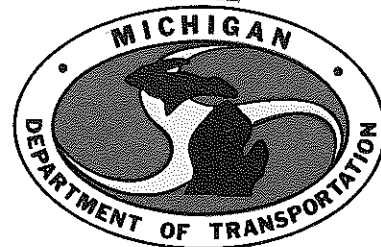

F159

**TESTING AND RESEARCH DIVISION
RESEARCH LABORATORY SECTION**

PCC PAVEMENT JOINT RESTORATION
AND REHABILITATION
(Federal Highway Administration NEEP Project 27)
Construction Report

J. E. Simonsen
F. J. Bashore
A. W. Price

Research Laboratory Section
Testing and Research Division
Research Project 79 F-159
Research Report No. R-1235

Michigan Transportation Commission
William C. Marshall, Chairman;
Lawrence C. Patrick, Jr., Vice-Chairman;
Hannes Meyers, Jr., Carl V. Pellonpaa,
Weston E. Vivian, Rodger D. Young
James P. Pitz, Director
Lansing, November 1983

The information contained in this report was compiled exclusively for the use of the Michigan Department of Transportation. Recommendations contained herein are based upon the research data obtained and the expertise of the researchers, and are not necessarily to be construed as Department policy. No material contained herein is to be reproduced—wholly or in part—without the expressed permission of the Engineer of Testing and Research.

SUMMARY

In 1968, the Michigan Department of Transportation initiated an experimental project to develop repairs for concrete pavements that could be opened to traffic the same day they were placed and also maintain their structural integrity for a number of years. The result was the use of precast concrete slabs as a standard repair method during 1972 and most of 1973. From 1974 until 1982, cast-in-place repairs using a 9-sack concrete mix with calcium chloride added for set and strength acceleration was the standard repair method. On the basis of experience with installing dowels in several repair joints, it was concluded that dowelling the joints would be impractical on contract work, because it was a labor-intensive and time consuming process. Consequently, undowelled joints were used on all repair projects during this period. Construction of the repairs required full-depth sawing of the repair limits using a diamond blade, lifting out the distressed concrete without disturbing the base, and sealing the repair joints.

The use of undowelled repairs was intended as an interim method to maintain the pavements until overlaying or reconstruction. However, the steady decline in highway revenues experienced during the seventies resulted in postponing needed overlays and reconstruction work. As a result, many of the undowelled repairs have served well beyond their intended life and some of the slabs have tilted, especially on the heavier traveled routes.

As a result of the dismal revenue outlook, it was apparent that better repair methods that would lengthen the service life of concrete pavements were needed. Thus, in 1979 the Department began testing various methods of constructing a non-tilting joint between new and old concrete. Based on previous work conducted in the early seventies, it was evident that the process of constructing the repair joints would need to be mechanized. A prototype drilling machine was constructed and it was determined that horizontal dowel holes could be machine-drilled into the hardened concrete slab at a rate of about one hole per 40 seconds. Once the drilling problem was solved, several types of tied joints, utilizing deformed bars, mortared into the drilled holes with epoxy, were tested. The most promising of these joints were field tested for constructibility in 1981 on a small experimental project. The results of the field test indicated that tied joints could be constructed without much difficulty. An expanded field experimental test section was constructed in 1982. This section contained tied joints, dowelled expansion and contraction joints, and inverted T slabs. A contract project containing about 2,700 repairs was constructed during 1982 and 1983. About 600 repairs have joints that were constructed by installing nine 1-5/16-in. diameter dowels in 1-3/8-in. diameter drilled holes. The remaining repairs have tied end joints with a dowelled expansion joint in the center. The tied end joints were constructed by sawing a 1/4 in. step at mid-depth of the end face of the existing slab and then epoxy mortaring seven No. 6 deformed bars into 1-3/8-in. diameter drilled holes.

Although tied joints installed on small scale research projects had performed satisfactorily, failures developed on those installed in the contract job. It was determined that the failures were caused by misproportioning of the epoxy binder. It was also evident that the hand filling of the holes with the mortar was a difficult task and required extreme care to ensure that the bars would have sufficient bond. Because of the problems experienced with constructing tied joints, the use of these joints has been held in abeyance for the time being.

As a result of the experience obtained during the construction of repairs, both experimentally and on the contract project, the Department is now using dowelled joints exclusively. Ten dowels, 1-5/16-in. diameter, are inserted in 1-3/8-in. machine drilled holes. Expansion joints are constructed by placing a compressible filler material over the dowels and against the existing concrete end face.

INTRODUCTION

In 1968, the Michigan Department of Transportation began an experimental program to develop concrete repairs for use on concrete pavements. As a result of this work, a repair procedure involving full-depth replacement of distressed slab areas was adopted in 1972. The procedure involved full-depth diamond blade sawing of the repair limits, lifting out the distressed areas without disturbing the base, and using precast slabs or a 9-sack concrete mix with calcium chloride added for early set and strength gain. The repairs utilized either undowelled expansion or contraction joints at the transverse repair limits.

During the experimental period, several joints were constructed utilizing dowels in the repair joints. These dowels were installed by drilling holes in the vertical end faces of the repairs into which the dowels were inserted. The drilling process used at the time required 35 minutes to drill the required number of dowel holes for each repair. The process was labor-intensive and the drill would often 'hang-up' in the holes, especially if the steel reinforcement was encountered.

Because of the difficulty and expense involved with installing dowelled joints, repairs using undowelled joints became standard until 1982. Evaluation of the undowelled repairs indicated that they would serve satisfactorily for about five years before excessive faulting developed. At the time repairs were intended as an interim procedure for maintaining the pavements before an overlay would be placed or the pavement reconstructed. However, the unforeseen decrease in funding, coupled with increased deterioration of the pavement which increased maintenance expenditures, necessitated the deference of overlays as well as reconstruction. Consequently, many of the undowelled repairs are now serving well beyond their intended time. As a result, excessive faulting has developed at some of those older repairs, especially on heavy commercial routes.

As revenues kept decreasing, it was evident that it would be necessary to maintain the concrete pavements for more years than anticipated. Therefore, repairs that would retain their smoothness for a 10 year, or more, period were needed. To accomplish this, the Department initiated an experimental study in early 1979 to develop a non-faulting joint for use with full-depth concrete repairs. A year later, the Department joined the FHWA sponsored NEEP Project 27, "PCC Pavement Joint Restoration and Rehabilitation."

This report deals with early laboratory development work and describes the procedures used in constructing the developed repairs. Early evaluation results are also included.

Background

The pavement design for which the repairs were developed is a 9-in. reinforced concrete slab with 99-ft joint spacing. The joints contain

1-1/4-in. plain steel dowels spaced 12 in. on centers and a baseplate beneath the dowel assembly's transverse centerline. The joint grooves were formed in the fresh concrete and sealed with a hot-poured rubber-asphalt sealant. Concrete pavements of this design range in age from 15 to 35 years.

The most common distress that occurs is the failure of transverse joints. These failures are caused by moisture, especially saltwater from snow removal, entering the joints through failed seals. The moisture is trapped by the baseplate and a triangular area of concrete bounded by the plate and up to the dowel is reduced to rubble. The severity of the failure is related to the moisture absorption characteristics of the aggregate used in the concrete: the more susceptible the aggregates are to moisture absorption, the more severe the deterioration.

Because the bottom of the slab has deteriorated as described, the repairs consist of full-depth slab replacement. Since the failures are confined to the slab itself and not related to the pavement foundation (which generally consists of a clay grade, 10 in. of sand, and a 4-in. aggregate base), the repair procedures do not require any reconstruction of the base materials.

In the sixties, the Department's concrete pavement design was changed to shorten the slab length to 71 ft, form the joint grooves by sawing, use preformed neoprene compression seals, and eliminate the baseplates. Corrosion resistant coatings have been required on dowel bars since 1974 and slab lengths were further reduced to 41 ft in 1979. These design changes have substantially retarded the deterioration at the bottom of the joints. Because the joint cross-section is basically still intact and capable of resisting compressive forces, the Department is currently implementing a preventive maintenance program for these pavements. The procedures involve partial depth joint repairs, seal replacement, and crack sealing.

Objective

The project objective was to develop a joint detail for use between a new and existing reinforced concrete slab that would retain its smoothness for at least 10 years. It must have sufficient strength to carry traffic within eight hours after installation and its construction must be adaptable to mass production techniques.

Scope

The scope of the project consisted of three parts:

- 1) Experimental laboratory work to develop suitable joints, installation techniques, and equipment.
- 2) Construction of selected joints for field evaluation. This part of the project was done in three stages:

a) Installation of a few repairs using two types of joints on a roadway with light commercial traffic, primarily to determine the feasibility of construction and evaluate their performance under light traffic loads.

b) A limited number of the experimental repairs were installed on a major roadway carrying a heavy commercial traffic volume, to evaluate their performance under such loading.

c) A contract to construct a large number of the repairs was let to determine their suitability for use on a production-type project and to obtain cost information when large quantities are involved.

3) Evaluation of the performance of the repairs by conducting measurements on joint movements, joint faulting, and visual inspections of the repair slabs.

A construction report covering the first stage construction operations (Research Report R-1179) was issued in August 1981. Pertinent parts of that report are included herein.

LABORATORY WORK

At the inception of the project, a review of the Department's earlier work with joining an existing and new concrete slab was reviewed. On the basis of that review, it was concluded that the successful joining of the slabs could best be accomplished by drilling horizontal holes into the vertical end face of the existing slab. It was also evident that for production-type work, the time to construct the joint would need to be drastically reduced from that experienced during installations made in the early seventies. It was decided that efficiency in joint construction could be improved by using mechanical equipment to drill the holes, relax the alignment requirements of the holes, and reduce the number of holes required. Consideration was also given to the availability of the equipment and materials required to construct the joint.

Hole Alignment - To construct a joint that will open and close in response to contraction and expansion of the slabs, the tolerance on alignment of the dowel holes must be quite close. To avoid the tolerance problem, a fixed joint was chosen, with the slab movements to be accommodated by installing a conventionally dowelled joint in the fresh concrete repair slab. The fixed joint would be constructed by epoxy mortaring No. 6 deformed reinforcement tie-bars into the drilled holes.

Required Number of Holes - On new construction projects, the number of dowels specified per 12-ft lane is 12 and for a tied construction joint 16, No. 6 deformed bars are required in a lane. To reduce the number of tie-bars (or drilled holes) needed to tie into an existing slab without

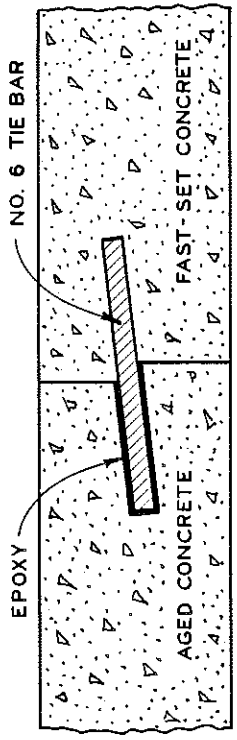

STEP

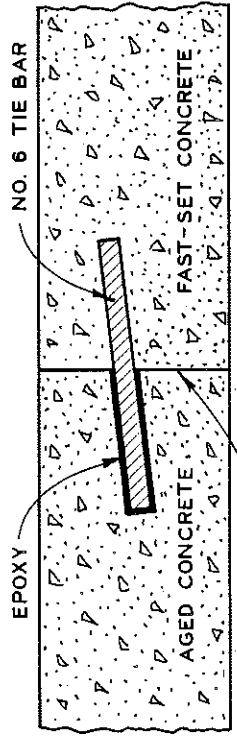

VERTICAL AND EPOXY

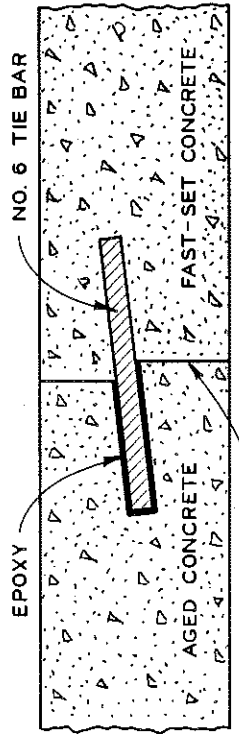

STEP AND EPOXY

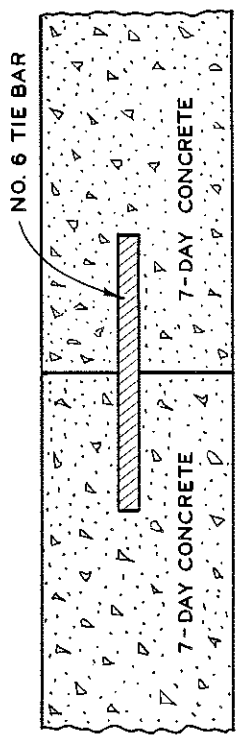

CONTROL

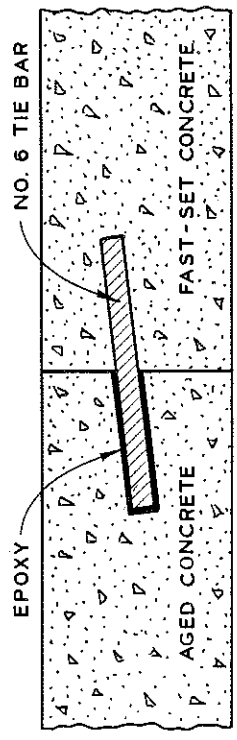

VERTICAL

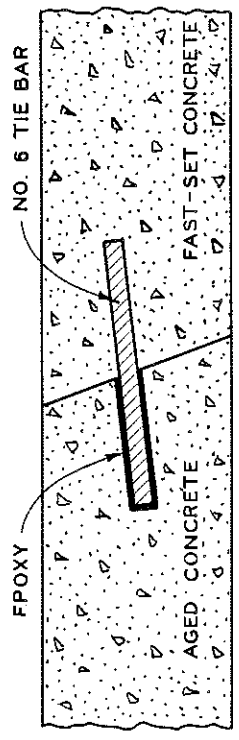

SLANT

Figure 1. Sections of tied control joint and experimental joints.

reducing the joint load transfer capacity, it was obvious that some of the shear load would need to be transferred to the concrete. This was done by variation in the vertical profile of the saw cut and/or coating the vertical slab face with epoxy. Figure 1 shows the sections of the various experimental tied joints and the control joint. The experimental joints were tested for static shear strength for a comparison with the strength of the control joint.

Drilling Equipment - For laboratory experimentation, the drilling machine consisted of a pneumatic sinker drill (30-lb class) with a two-way air cylinder attached to the drill handle (Fig. 2). The drill and cylinder were mounted on sliding plates with the bottom plate fastened to a metal frame. A carbide-tipped rock bit was used to drill the holes. To prevent oversize or spalled holes as the bit contacted the concrete face, the bit passed through a guide bushing positioned against the concrete.

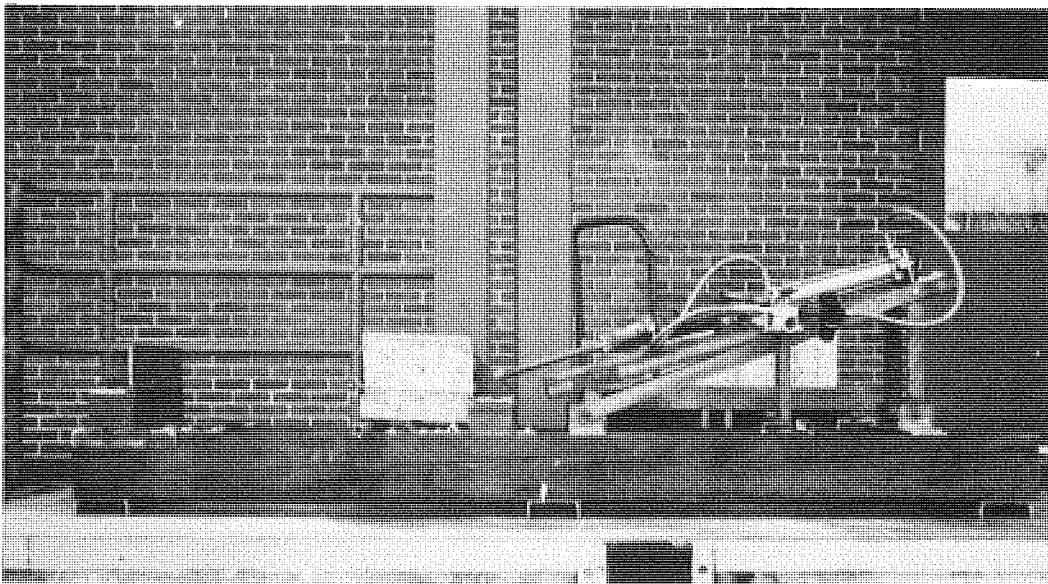

Figure 2. Drilling machine constructed and used for drilling holes in concrete samples cut from an 18-year old existing pavement.

Test Procedure

The test program consisted of two phases with the following objectives: Phase 1 - The objective of these tests was to develop tied joints comparable in shear strength to the type of tied joint permitted in new construction but with a reduced number of tie-bars. The joints were to be tested when the concrete had attained normal concrete pavement strength (3,500 psi minimum in compression). Phase 2 - The objective was to determine shear strengths of tied joints when the concrete strength was in the range of that for repair slabs cast and opened the same day (300 psi minimum flexural strength).

Sample Preparation - The type of joints tested in Phase 1 were: vertical, slant, step, and the control (Fig. 1). Three samples of each type were prepared and the sample size of each half was 10 in. high, 12 in. wide, and 12 in. long. A No. 6 deformed tie-bar 18 in. long was embedded 9 in. into each sample half. The control sample was cast from a 7-sack high early strength concrete mix. One-half was cast first with the tie-bars extending out of one end. This half was cured seven days. The other half was then cast and cured seven days before testing the shear strength of the sample joint. The average seven-day compressive strength of the concrete was 4,700 psi (Table 1).

One end of the experimental samples was saved from a concrete slab removed from an 18 year old pavement. The slant and step cuts were made in the field using a diamond bladed saw. These 'aged' concrete blocks were then fastened in the drill machine and a 1-3/8 diameter hole, 9 in. deep, was drilled into the joint face of each block. The holes were located at mid-depth and were drilled downward at an angle of 10°. This downward slope of the holes was intended to aid the insertion of epoxy mortar into them.

The epoxy mortar consisted of approximately three parts dry masonry sand to one part (by volume) of a fast-set two-component epoxy binder, low temperature curing, with a gel time from 8 to 15 minutes. The mortar was rodded into the holes and the tie-bar pushed into the mortar by hand. Excess mortar extruding from the holes was cleaned off the concrete face. As soon as the bar was inserted, the other half of the sample was cast. The concrete was a 9-sack mix with calcium chloride added for set and strength acceleration. The samples were cured 24 hours before testing the shear strength of the joint. The 24 hour average compressive strength of the concrete was 4,800 psi (Table 1).

The types of joints included in the second test phase were: vertical, step, vertical with epoxy, and step with epoxy (Fig. 1). The slant type joint was eliminated from the second test phase because the rather low increase in strength obtained with the type of joint during Phase 1 and the difficulty in sawing a slant cut were judged to be sufficient evidence that it would not meet the objective of the study.

Three samples of each type were prepared using a 9-sack mix with calcium chloride. The samples were prepared in the same manner as Phase 1, except that a 12-in. long No. 6 tie-bar, was embedded 6 in. into each half of the sample. In addition, three samples of the vertical and step type joint with a 16-in. long tie-bar, embedded 8 in. into each sample half, was prepared. The different tie-bar embedment lengths were used to determine the effect of embedment length on shear strength. The average compressive concrete strength at the time of testing the joints was 2,100 psi (Table 1).

The epoxy coat was brushed on the end face of the concrete block prepared from the existing pavement just prior to casting the fresh concrete against it. The epoxy was a fast-set two-component epoxy binder low temperature curing with a gel time of 8 to 15 minutes.

Test Procedure - All samples were subjected to a single shear load by fastening the aged concrete portion of the sample in a stationary fixture and applying the load through a hydraulic ram connected to an MTS machine (Fig. 3). A load cell in the ram was connected to the MTS console and a load curve for each sample was obtained on an x-y plotter (Fig. 4). The load was applied 1 in. from the joint face on the fast-set concrete portion of the sample. The load was applied until failure occurred which was indicated by a sharp dip on the load curve.

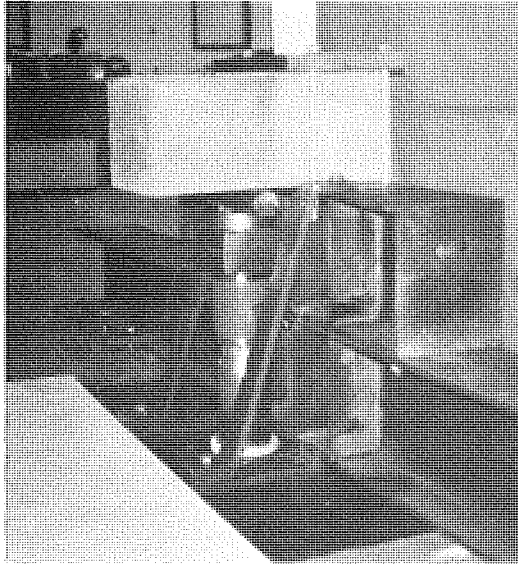

Figure 3. Shear test set-up. The specimens were turned upside-down and loaded from bottom as the load ram is mounted in a pit in the floor.

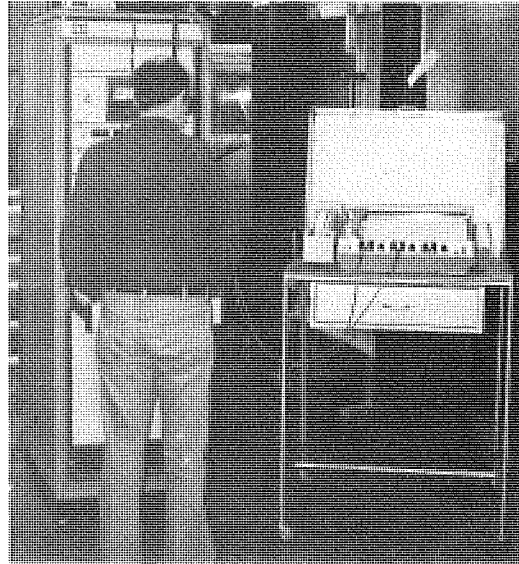

Figure 4. MTS console with x-y plotter for recording loads.

Test Results - Table 1 lists the results of the shear tests for both test phases. Since embedment length of the tie-bars did not significantly affect the load capacity, the results for Phase 2 tests include both lengths.

Discussion of Test Results - As shown in Table 1, the test loads for the control joint averaged 14,000 lb. Thus, the total load capacity of a 12-ft lane joint containing 16, No. 6 tie-bars (approved design for a construction joint in new pavement) would be 224,000 lb. Since one tie-bar in a step-cut joint has a load capacity of 30,000 lb, a lane joint of this type would need to contain only seven tie-bars to be nearly equivalent to the strength of the approved construction joint. That is, of course, with concrete having compressive strength normally associated with pavement concrete.

From the Phase 2 test results, it is evident that none of the experimental joints tested at an average concrete compressive strength of 2,100 psi would have the required load capacity using only seven No. 6 tie-bars.

However, the vertical and epoxy, and the step-cut joints have about equal strength in a 2,100 psi compressive strength concrete to that of the control joint tested when the concrete had a 4,700 psi compressive strength. The step and epoxy joint developed 4,000 lb more load capacity than either the vertical and epoxy and the step joint which is still insufficient to achieve the required strength using only seven tie-bars.

Essentially, the test results indicate the difficulty in reducing the number of tie-bars required at low concrete strengths and still maintain a load capacity comparable to the control joint. One way of reducing the number of tie-bars would be to reduce the safety factor against concrete bearing failure under the bars, the normal failure mode of this joint type. The control joint is designed with a concrete bearing safety factor of about 3.0. Cutting the safety factor in about half would allow the desired reduction in the number of tie-bars. It should be noted that once the concrete is about 24 hours old, the safety factor is back to about 3 again.

TABLE 1
TEST RESULTS

Test Phase	Joint Type	Average Concrete Compressive Strength, psi	Average Failure Load, lb
1	control	4,700 ¹	14,000
1	vertical	4,800 ²	15,000
1	slant	4,800 ²	20,000
1	step	4,800 ²	30,000
2	vertical	2,100 ³	7,000
2	vertical and epoxy	2,100 ³	13,000
2	step	2,100 ³	14,000
2	step and epoxy	2,200 ³	18,000

¹ seven day strength, 7 sack mix

² 24 hour strength, 9 sack mix with calcium chloride

³ six hour strength, 9 sack mix with calcium chloride

The ultimate pull-out strength of a tie-bar embedded in the epoxy mortar in a 6-in. deep, 1-3/8-in. diameter hole in a concrete block cut from an existing slab was determined. The epoxy mortar was cured eight hours before testing. On the basis of three tests, the average pull-out resistance of the bars was 22,000 lb. In all cases, the failure occurred when the concrete block broke. On the basis of the test results, it was decided that the vertical and epoxy, and the step-cut tied joints, each containing seven No. 6 deformed tie-bars, would be subjected to a field trial.

FIELD TESTING

The field test portion of the project, as previously mentioned, was divided into three stages with each one involving the following work:

1) Installation of a few repairs using promising types of field joints on a roadway with light commercial traffic, primarily to determine the feasibility of construction and their performance under light traffic loads.

2) A limited number of experimental repairs would be constructed on a major roadway carrying a heavy commercial volume, to evaluate their performance under such loading.

3) A contract to construct a large number of the repairs would be let to determine their suitability for use on a production type project and to obtain cost information when large quantities are involved.

The repairs would be evaluated for performance during the first 24 hour period when the safety factor against failure is less than that normally used in joint design calculations. Long-term evaluation will also be conducted.

Construction Operations and Materials

Construction of the experimental repairs included in Stages 1 and 2 was done by Department personnel from the Research Laboratory and the Maintenance Division. The Stage 3 repairs were done by contract. Many of the operations and materials used in constructing the repairs are the same for all three stages. The operations and materials common to each stage will be described before discussing those unique to a particular project stage.

Determining Repair Limits - The minimum section of pavement replaced with a full-depth repair is 6 ft long and one lane wide. This minimum section was established on the basis that this area was needed to provide adequate work space in the repair area, and to minimize rocking of undowelled slabs under traffic. The same slab size was carried over to the dowelled repair system, primarily because the work area was needed for the drilling equipment.

The majority of the failures can be repaired using the minimum slab size. Any increase in the repair length is determined by the surface condition of the existing pavement. The repair limits shown on the plans are estimates made during a pavement condition survey and the final limits are determined by the Project Engineer. Repair lengths are measured to the nearest foot.

Sawing - All perimeter saw cuts are full depth and made with a saw equipped with a diamond blade. A second saw cut is made inside the one transverse end limit. The width of the concrete wedge resulting from

these cuts tapers from about 6 in. at the shoulders to about 4 in. at the lane joint. Sawing the area in this manner allows easy removal of the small sliver of concrete to relieve pressure in the slab. At the option of the contractor, this interior saw cut may be omitted if the contractor can remove the distressed slab without damaging the edges of the slab to be left in place. To facilitate removal of slabs longer than 6 ft, additional transverse saw cuts are made.

Concrete Removal - The distressed concrete is lifted out to ensure the base is left in an undisturbed condition. This is accomplished by drilling holes through the sound portions of the failed slab and inserting lifting devices in the holes. A cable or chain sling is attached to the lift devices and a crane or front-end loader is used to lift the slab out. Smaller debris left in the repair area is removed by careful use of a backhoe or similar piece of equipment, and by hand tools. The removed concrete is loaded onto trucks and hauled away for disposal.

Form Setting - Wood planks are used as forms along the shoulder. The plank extends a few inches beyond the concrete edge at each repair end and is held in position either by staking or by backfilling with shoulder material. The inside edge of short repairs was normally not formed and the concrete was cast against the existing lane concrete. On long repairs, forms are used on both edges to ensure that the correct repair grade was maintained.

Steel Placement - For repairs 8 ft or less in length, the welded wire mesh reinforcement was placed with the heavy wires perpendicular to the pavement edge. For repairs over 8 ft long, the heavy wires are placed parallel to the pavement edge in the conventional manner.

Joint Types and Installation - The experimental joint types and the installation procedures used during each of the three construction stages will be described later in the report when discussing each individual construction stage.

Concrete Pouring - The concrete is delivered in ready mix trucks from a concrete plant. The specified slump of the concrete as delivered to the site is between 1 and 3 in. Flake calcium chloride is added in the specified amount (see "Concrete Mix Design" Table) at the site and mixed into the concrete.

The concrete is consolidated using an immersion-type hand-held vibrator and struck-off at least twice with a vibratory screed. The joint grooves are formed by inserting a wood strip in the fresh concrete at the joint location. Final surface finishing is done by floating and straight-edging the surface. The slabs are broomed transversely to texture the surface. A white membrane curing compound is sprayed on the surface to prevent moisture loss from the slab. The groove forming strips are removed from the concrete prior to the concrete attaining its initial set.

Curing blankets are required when the air temperature falls below 65 F during the curing period.

CONCRETE MIX DESIGN
(The concrete is a 9-sack mix proportioned as follows.)

Ingredient	lb/cu yd
Cement, Type 1 or 1A	846
Coarse Aggregate, 6A	1,857
Fine Aggregate	874
Net Water	288
Calcium Chloride* - below 45 F	45
(Flake Type) 45 to 60 F	36
60 to 75 F	27
above 75 F	18

* Calcium chloride added to mix at the job site. Slump range prior to adding calcium chloride, 1 to 3 in. Air content (percent), 5.5 ± 1.5 .

Tie-Bars - Deformed tie-bars conformed to the requirements of ASTM A706 or for Grade 60 of ASTM A615, A616, A617.

Dowels - Dowels were required to have a minimum yield strength of 40,000 psi.

Reinforcement - The reinforcement conformed to the requirements of ASTM A185. Approximate weight/sq yd was 6.3 lb.

Curing Compound - The white membrane curing compound used met the requirements of ASTM C309, Type 2, Class B Vehicle.

Joint Sealant - The hot-poured type joint sealant conformed to the requirement of ASTM D1190.

Epoxy - The epoxy consisted of a fast-set two-component epoxy binder, low temperature curing, with a gel time of 8 to 15 minutes, meeting the Department's 1979 Standard Specification 8.16.05.

EXPERIMENTAL JOINT INSTALLATION

The experimental joint installation procedures used in each of the three construction stages are described as follows.

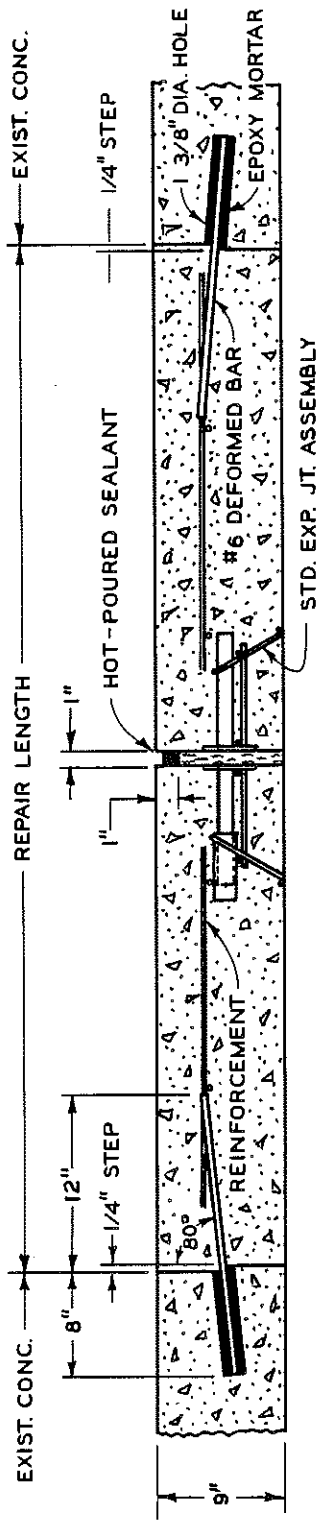

a. Repair with step-cut end limits.

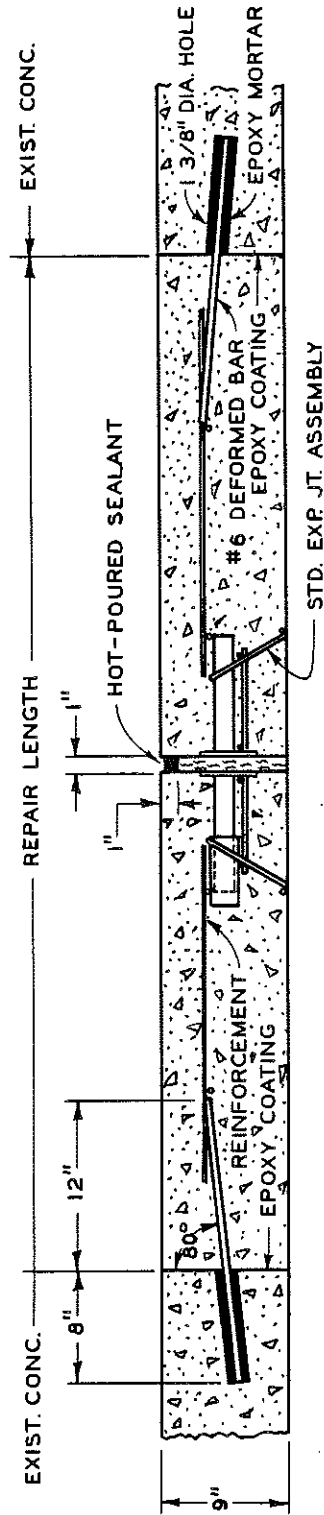

b. Repair with epoxy coated end limits.

Figure 5. Experimental types of repairs.

Stage 1

Repair Locations - The pavement on which the construction feasibility work was done is located on US 127 between I 96 and M 36 south of Lansing. It is 15 years old and consists of two 24-ft roadways of reinforced concrete 9 in. thick. The joints are spaced 71 ft apart and consist of 1-1/4-in. diameter dowels, 18 in. long, on 12-in. centers. The joint grooves were sawed and preformed neoprene seals were used to seal the joints. The 1977 ADT volume was 5,500 (each roadway) with the commercial volume estimated at 9 percent.

Four joints were selected for repair, two on the southbound roadway and two on the northbound roadway.

Joint Types - Two tied joint types were used (Fig. 5). One type utilized a 1/4-in. sawed step at mid-slab depth and the other a vertical sawed joint face with an epoxy coat applied prior to placing the concrete. Both joint types were constructed by drilling seven 1-3/8-in. diameter holes into the vertical end faces of the repairs and epoxy mortaring No. 6 deformed bars, 20 in. long, into the holes. The hole spacing was 12-18-18-24-24-18-18-12 in. (that is, the first and last holes are 12 in. from a lane edge). The holes were 8 in. deep and drilled at an angle of 10° above horizontal to aid in inserting mortar into the holes. The repairs are reinforced and a standard 1-in. expansion joint was installed in the center of the repair to accommodate slab length changes.

Installation Procedure - The full-depth saw cuts at the repairs utilizing an epoxy coat were made in the conventional manner using a single diamond blade. The step-cuts were made by mounting two 3/16-in. thick, 18-in. diameter blades against one side of the 26-in. diameter blade (Fig. 6).

A special drilling rig was made in the Laboratory's Machine Shop to eliminate the use of hand-held drills, and to increase the speed of drilling holes in the hardened concrete (Fig. 7). It consists of back-to-back 12-ft long channels with slip brackets to fit the bucket of a front-end loader. A sinker drill (30-lb class) along with an air cylinder to provide pressure for both forward and backward motion of the drill was hung on rollers from the bottom flanges of the channels. The roller mounting arrangement provided for transverse movement of the drill across the 12-ft wide slab. To reduce friction during drilling, drill movement was facilitated using a slide plate with ball bearings. The drill was positioned on a 10° angle above a horizontal plane.

Prior to installing the tie-bars, the holes were blown clean using compressed air. Then the holes were hand filled with epoxy mortar and the bars pushed into the mortar. The mortar that extruded during the bar insertion was smoothed off at the joint face.

Figure 6. Saw blade mounting arrangement to make step saw cut—one 26-in. blade with two adjacent 18-in blades.

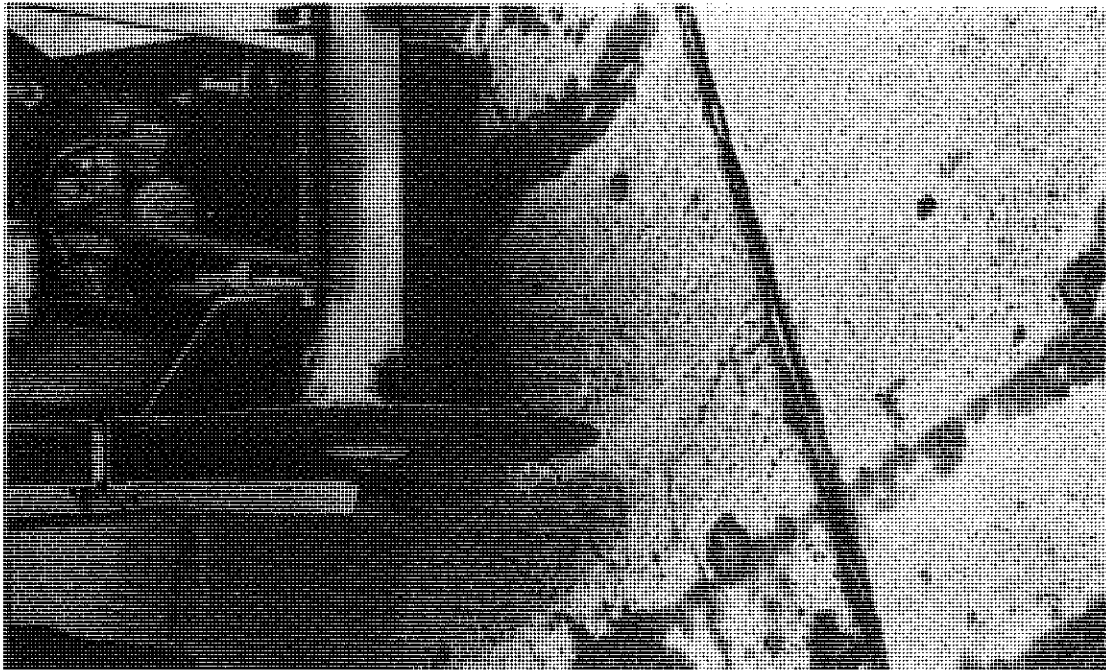
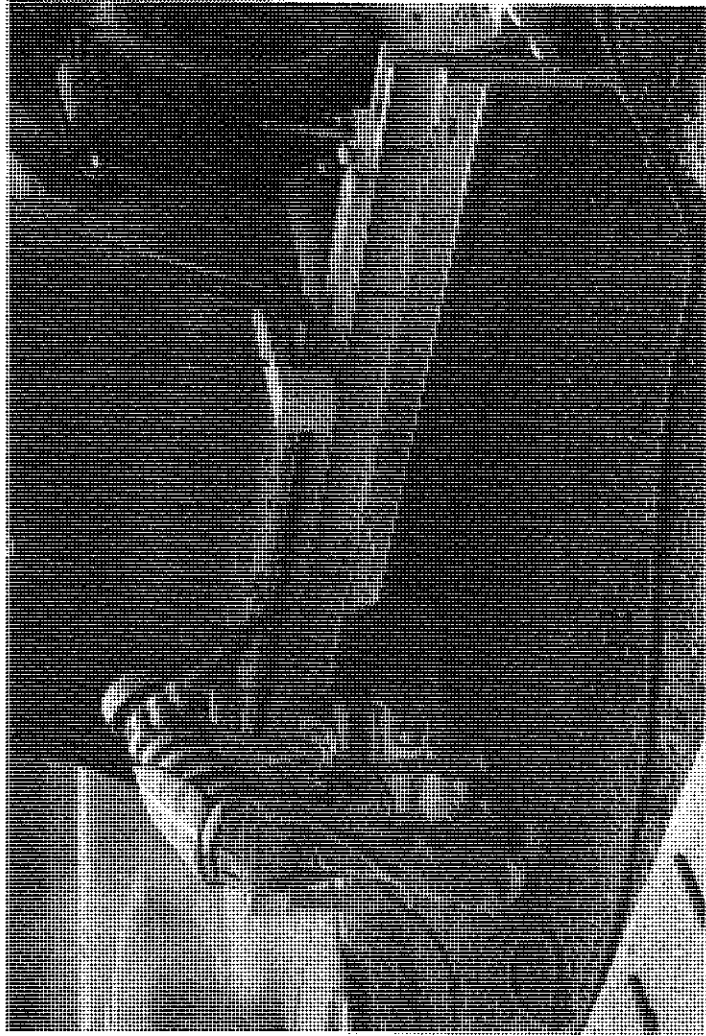

Figure 7. Drilling holes for tie bar installation. Dark lines on support channel indicate hole locations.



Once the tie-bars were installed, a 1-in. expansion joint assembly was placed in the center of the repair and the reinforcement positioned (Fig. 8). The fast-set concrete was placed and finished in the conventional manner. A completed repair prior to opening to traffic is shown in Figure 9.

Observation of the drilling operation indicated that machine drilling of holes in hardened concrete would be feasible. Timing of the operation showed that on the average a hole could be drilled in about 40 seconds. The installation of the tie-bars was more time consuming—one minute per bar per man. Moreover, the installation needed to be carefully done to ensure that the space around the bar was completely filled with mortar so that the required strength of the joint would be obtained.

The performance of the tied joints, during the first few hours after opening to traffic, when the safety factor against bearing failure under the bar is at a minimum, was checked by taking cores through the joints the morning following construction. Examination of the cores revealed that the tie-bars were holding the joint tightly together at mid-depth and there was no visible sign of bearing failure under the bars. At the surface, a hairline crack was visible at the joint locations. The width of these cracks, measured by use of calipers inserted into gage plugs placed on each side of the joint, ranged from 0.007 to 0.030 in.

One of the cores from a joint where an epoxy coat was applied to the existing joint face prior to concrete placement showed that the epoxy had failed to bond the two surfaces together. This failure was taken as an indication that bonding the two surfaces with epoxy would not be a reliable method to improve the load carrying capacity of the joints.

Based on the encouraging results of the field installations, it was recommended that Stage 2 of the project—installation of the experimental repairs on a heavy truck route—be carried out. This recommendation was approved by the Department's Engineering Operations Committee. Furthermore, the committee requested that a contract project utilizing the experimental joints be prepared for letting in 1982 rather than as planned for 1983.

Stage 2

As a result of the decision to move the Stage 3 work up one year, the Stage 2 and 3 portions of the project would be carried out simultaneously. Consequently, any new information obtained from the Stage 2 work would not be available for use in setting up a contract for the Stage 3 project portion. Therefore, rather than constructing and evaluating only the joint types installed in the Stage 1 project portion, the scope of the Stage 2 work was expanded to include a total of six different joint types.

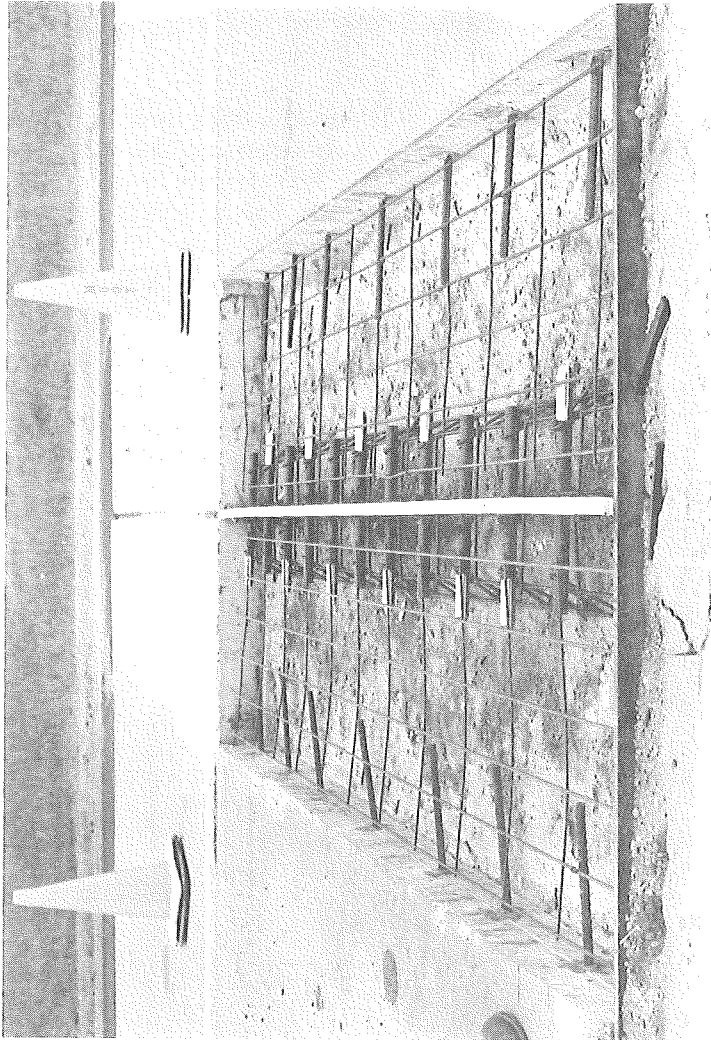

▲ Figure 8. Repair area just before placing concrete. On short length repairs the reinforcement is placed with heavy wires in the transverse direction.

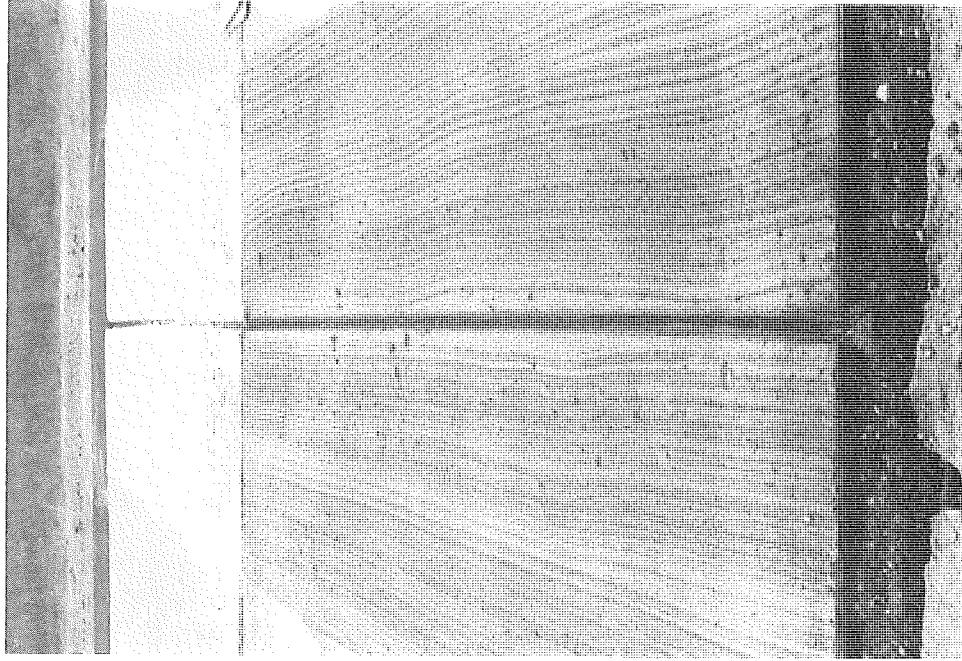

▲ Figure 9. Appearance of finished repair before applying the curing compound and joint sealant.

Repair Locations - The Stage 2 repairs were constructed on I 94 in Calhoun County on the westbound roadway. The pavement was built in 1961 and consists of two 12-ft lanes of 9-in. reinforced concrete. The slab lengths are 99 ft and the joint grooves were formed in the fresh concrete. The sealant used was a hot-poured rubber-asphalt. A baseplate was placed at the transverse centerline of the load transfer dowel assembly. The 1979 ADT was 9,200 (per roadway) with the commercial volume estimated at 20 percent. Eighteen locations were selected for repair on about a half-mile section just west of 22-1/2 Mile Rd.

Joint Types - Six different joint types were constructed. Each type was used in both lanes at three repair locations. Figures 10 through 15 are cross-section sketches of the repairs and below each figure the joint details are described.

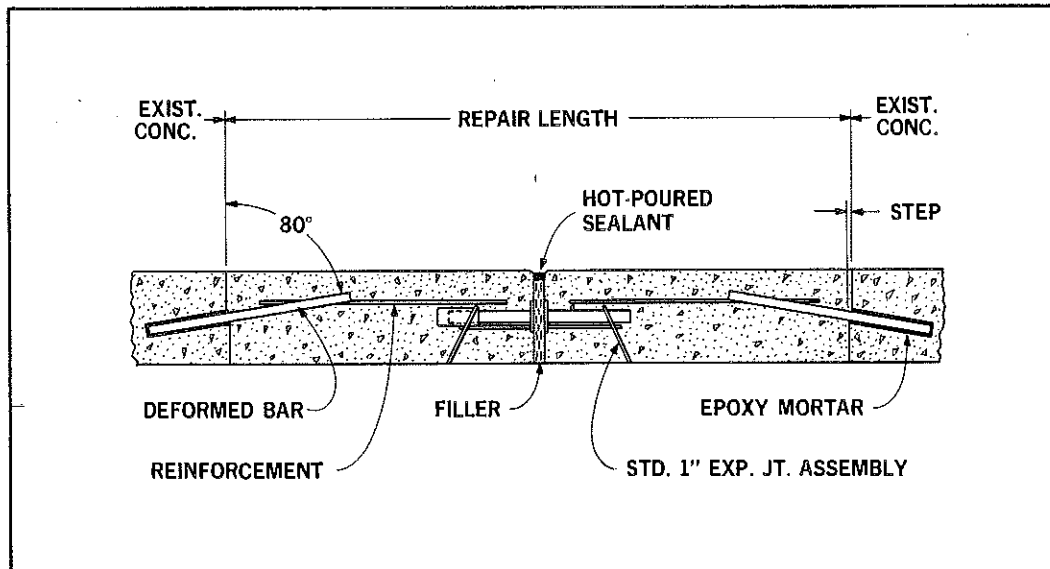

Figure 10. Step-cut tied end joints (expansion joint in center).

The end joints had a 1/4-in. wide sawed step at mid-depth (constructed by mounting two 18-in. blades next to a single 26-in. diameter blade). Seven No. 6 deformed bars, 20 in. long were set in epoxy mortar in 1-3/8-in. diameter holes, drilled 8 in. deep into the end face at mid-depth of the slab. The bar spacing was: 12-18-18-24-24-18-18-12 in. (the first and last bar were 12 in. from the lane edge). A conventional 1-in. expansion joint was installed in the repair's center to accommodate slab length changes.

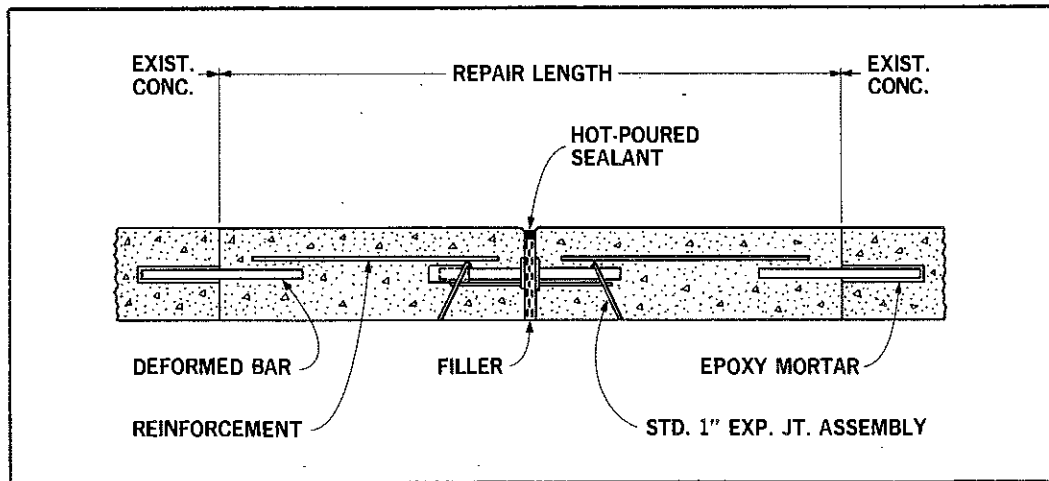

Figure 11. Straight cut tied end joints (expansion joint in center).

This type of tied joint utilized more and larger tie-bars than used in the joint discussed in Figure 10, to provide sufficient shear strength to transfer load across the joint. Nine No. 8 deformed bars, 20 in. long were set in epoxy mortar in 1-3/8-in. diameter holes drilled 8 in. deep into the end face at mid-depth of the slab. The bar spacing from edge to edge of the lane was: 12-18-12-12-18-18-12-12-18-12 in. A conventional 1-in. expansion joint was installed in the repair's center to accommodate slab length changes.

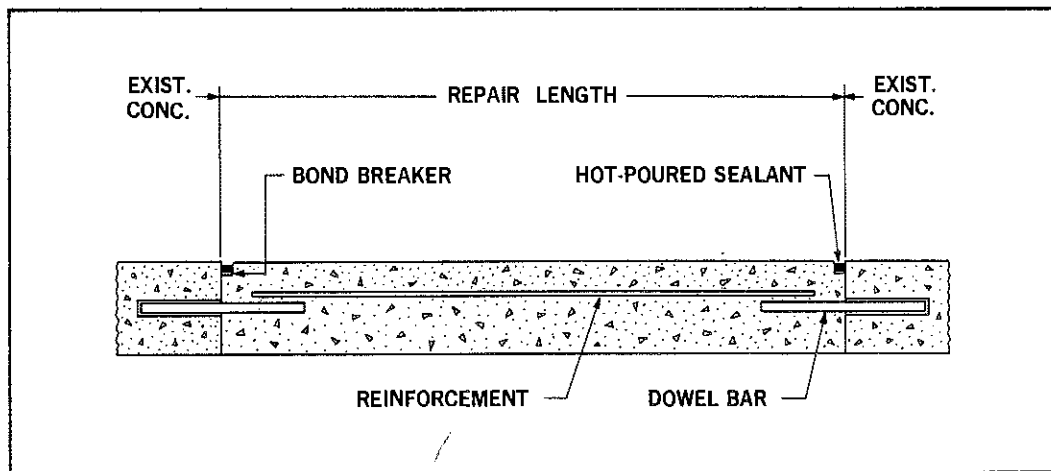

Figure 12. Dowelled contraction joints.

A contraction joint was constructed at each end by placing nine 1-5/16-in. diameter steel dowels, 14 in. long in 1-3/8-in. diameter holes drilled 7 in. deep into the end face at mid-depth of the slab. The spacing from edge to edge of the lane was: 12-18-12-12-18-18-12-12-18-12 in.

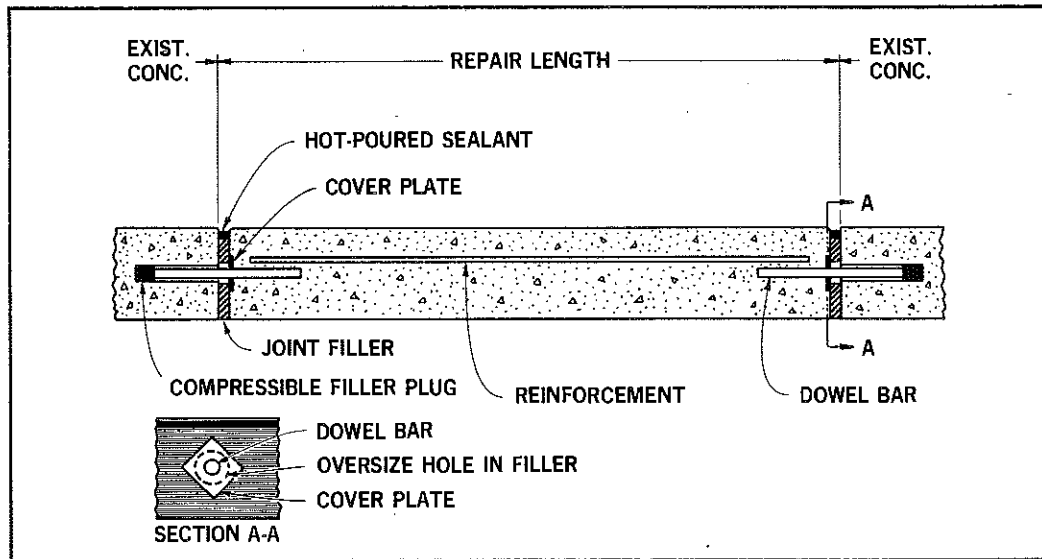

Figure 13. Dowelled expansion joints.

A 1-in. expansion joint was constructed at each end joint by placing nine 1-5/16-in. diameter steel dowels, 14 in. long in 1-3/8-in. diameter holes drilled 7 in. deep into the end face at mid-depth of the slab. A compressible joint filler with oversize holes was placed over the dowels and against the end face (the holes were oversized to accommodate allowed tolerance on dowel spacings). A coverplate was placed over the oversized hole to prevent concrete from filling the space around the dowel.

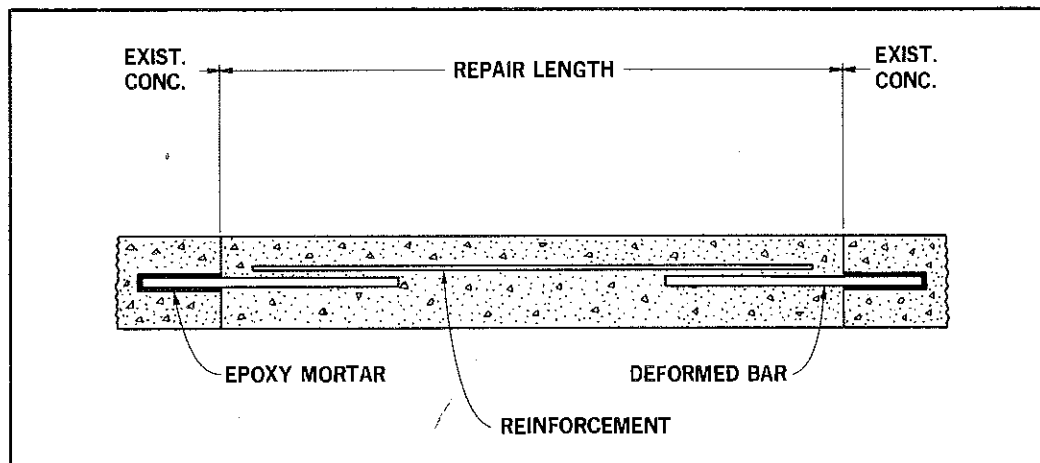

Figure 14. Tied end joints.

The tied end joints were constructed by epoxy mortaring nine No. 6 bars, 32 in. long into 1-3/8-in. diameter holes drilled 8 in. deep into the end face at mid-depth of the slab.

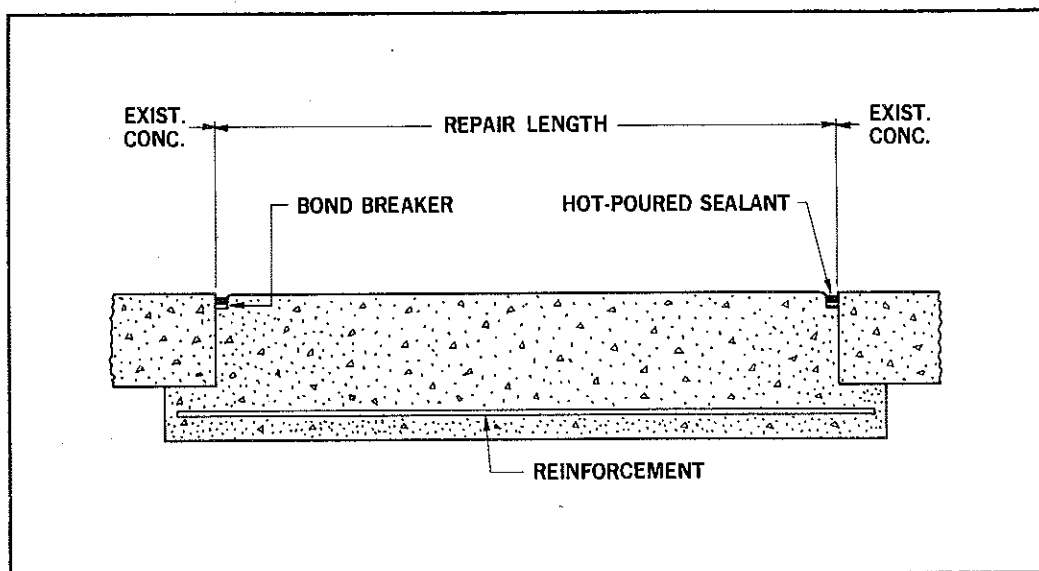

Figure 15. Inverted T-slab repair.

This type of repair is intended to prevent faulting of the repair joints by extending the repair slab under the existing slab ends. It has been used with some success in other states and was included in this project to test it for comparison to tied or dowelled joints. The construction involved removing 6 in. of base material for the length of the repair plus 6 in. under each slab end. A layer of reinforcement was placed 3 in. above the new base elevation and extending under the existing slab for 4 in. each end.

All tied joints were constructed without provision for sealing them. Dowelled joints and the joints at the ends of the inverted T-slab repairs were sealed by installing a hot-poured rubber-asphalt sealant in a joint groove formed in the fresh concrete.

Installation Procedure - The installation procedure used followed those described for the Stage 1 work. The holes were drilled with the Laboratory's prototype drilling machine and the epoxy mortar was placed in the holes by hand and rodded before inserting the tie-bars. Where dowels were used, the holes were simply cleaned with compressed air prior to inserting the dowels.

The construction operations were completed in mid-June of 1982. The repairs were constructed using a 9-sack concrete mix with calcium chloride added for set and strength acceleration so the repairs could be opened in daylight hours of the day cast. The machine drilling of holes into the hardened concrete was accomplished without problems, which further demonstrated the feasibility of constructing joints utilizing horizontally drilled holes when repairing concrete pavements.

Stage 3

The success in mechanizing the hole drilling operation prompted a reconsideration of the type of repair joints to be specified on the Stage 3 contract project. First, as previously mentioned, a few experimental dowelled joints were used in repair joints during our experimental work in 1970-72. These joints contained 1-3/16-in. diameter dowels in 1-1/4-in. diameter drilled holes. Three of these joints were instrumented with gage plugs for measuring faulting of the joints. After 10 years of service on a pavement with an ADT volume of 7,100 each way (15 percent commercial), the elevation change of the joints ranged from 0.04 to 0.12 in.

Secondly, additional work was conducted during the fall of 1981 by research personnel to determine the hole alignment obtained with our prototype drilling machine. It was determined that machine-drilled holes, perpendicular to the sawed joint faces within plus or minus 1/8 in. could be obtained on a consistent basis. This alignment tolerance was judged to be satisfactory to allow the dowels to slide in the drilled holes.

On the basis of this information, it was decided that dowelled joints constructed by inserting 1-5/16-in. dowels into 1-3/8-in. drilled holes would be used in conjunction with repairs having tied end joints and an expansion joint in the center.

Repair Location - The pavement selected for contract repair was located on I 94 in Jackson County, beginning at the Jackson-Calhoun County line and then easterly to the Airport exit, a distance of about 14 miles. The ADT (1979) was 11,000 on each roadway with an estimated 20 percent commercial vehicles. The pavement ranges in age from 23 to 29 years. It consists of a 9-in. reinforced concrete slab with dowelled joints spaced at 99 ft. The formed joint grooves were sealed with hot-poured rubber-asphalt sealant and a baseplate was installed at the bottom of the joints.

Joint Types - Two types of joints were selected for use—one a contraction joint and one a tied joint (in conjunction with an expansion joint). Figure 16 shows the cross-section of the tied joints with expansion joint and Figure 17 shows the contraction joint cross-section. A description of the joints is given below each figure.

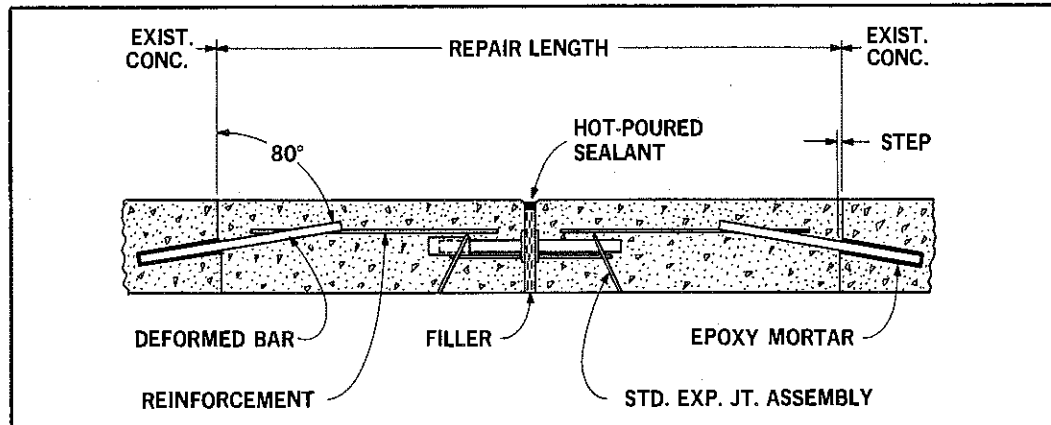

Figure 16. Step-cut tied end joints with a 1-in. expansion joint in center (Type X repair).

The end joints had a 1/4-in. wide sawed step at mid-depth (constructed by mounting two 18-in. blades next to a single 26-in. diameter blade). Seven No. 6 deformed bars, 20 in. long were set in epoxy mortar in 1-3/8-in. diameter holes, drilled 8 in. deep into the end face at mid-depth of the slab. The bar spacing was: 12-18-18-24-24-18-18-12 in. (the first and last bar were 12 in. from the lane edge). A conventional 1-in. expansion joint was installed in the repair's center to accommodate slab length changes.

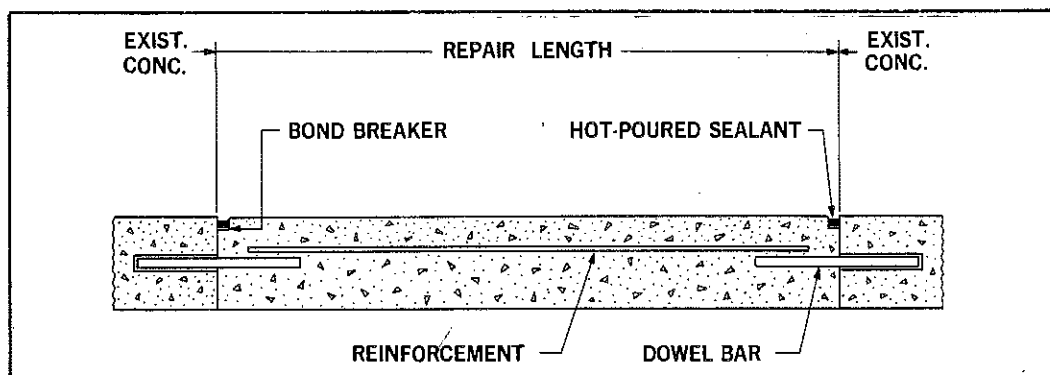

Figure 17. Dowelled contraction joints (Type Y repair).

A contraction joint was constructed at each end joint by placing nine 1-5/16-in. diameter steel dowels, 15 in. long in 1-3/8-in. diameter holes drilled 7-1/2 in. deep into the end face at mid-depth of the slab. The spacing from edge to edge of the lane was: 12-18-12-12-18-18-12-12-18-12 in.

A total of about 2,700 lane locations were selected for repair. Of these, 600 repairs were set up as Type Y repairs (repairs having contraction joints) and the remaining ones were Type X repairs (tied end joints with a center expansion joint). The Type Y repairs were scattered among the Type X repairs to equalize the expansion space as much as possible throughout the length of the project.

Contract Documents - The experimental repairs were included in Michigan Project IR 38101, Job No. 18171A. (Federal No. IR 94-3(152) 123). The project, in addition to the repairs, included shoulder and ramp bituminous paving.

The plans and specifications covering the project were prepared by the Department's Design Division and construction operations were supervised by the Construction Division. Special provisions and details concerning the repairs were prepared by the Research Laboratory. A copy of these are included in Appendix A.

The project was advertised for letting May 19, 1982. Prior to letting, a pre-bid meeting was held for prospective bidders to ensure that they would be informed of the procedures and materials required to construct the experimental repairs.

Repair Cost - The project was awarded to the low bidder for a total cost of \$2,115,615.17. Of this amount, \$1,374,913.00 was for the joint repair portion of the contract. The remaining portion was for the bituminous and other miscellaneous work plus traffic control. The cost of the repairs on a per sq yd basis was \$55.32 excluding traffic control cost.

Joint Installation - The step-cut required for Type X repairs was made by mounting an 18-in. diameter blade next to one side of the 26-in. diameter blade. Then when the repair area was cleaned out, the holes for the tie-bars were drilled. The drilling machine had two individually controlled drills mounted on a track so they could be moved transversely and locked in position at the required location (Fig. 18).

The holes were blown clean with oil-free compressed air and the epoxy mortar was placed in the holes by hand. To ensure that the holes were completely filled, the mortar was rodded with a bar. The tie-bars were pushed into the mortar and any mortar extruded during the installation process was smoothed off with a gloved hand. The contractor was allowed to place the concrete as soon as the bars were installed since the mortar would cure along with the fresh concrete.

For the Type Y repairs, the end limits were sawed using a single blade. The holes were drilled horizontally and after cleaning with compressed air the dowels were placed in the holes.

The joint grooves were formed using a wood strip inserted in the fresh concrete prior to finishing the slab surface. The grooves were cleaned

using sandblasting and compressed air and then sealed with a hot-poured rubber-asphalt sealant.

The performance of the tied joints was checked a few days after construction started by coring through the tie-bar locations. The cores indicated that the bars were properly installed and performing as intended. However, when cooler weather was encountered, it was noted that some tied joints had opened excessively. Cores taken through these joints revealed that the epoxy had not cured satisfactorily. It was determined that this was the result of inaccurate proportioning of the epoxy binder.

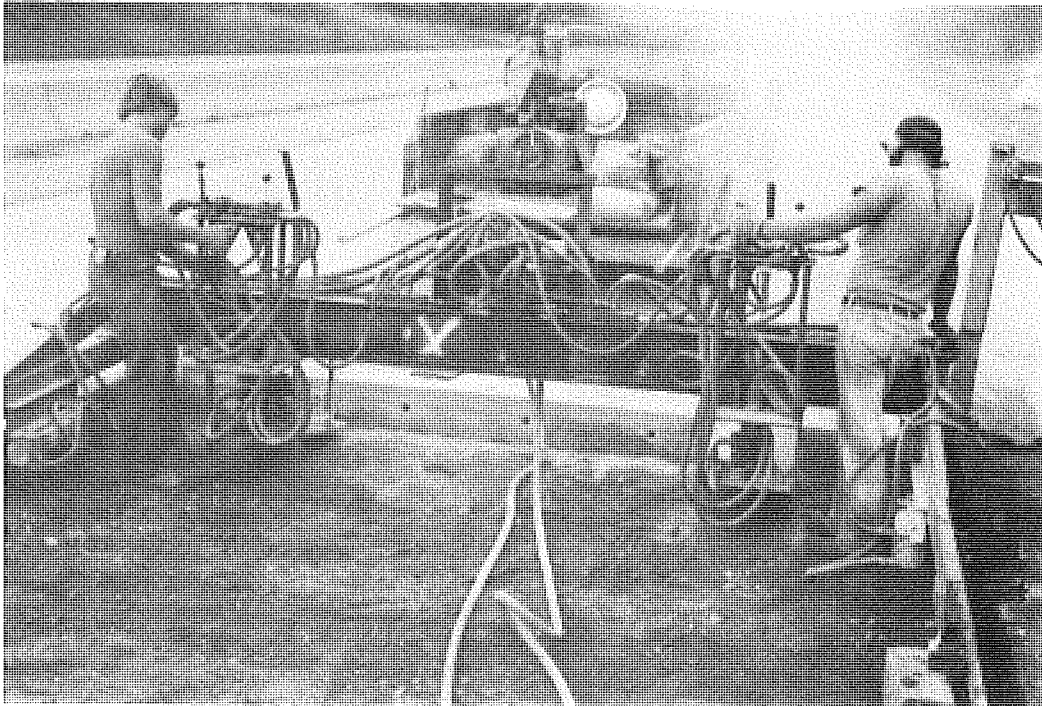

Figure 18. Drilling machine with two drills mounted on a track. Each drill is individually controlled.

To ensure that future repairs would have properly installed tie-bars, a sample of the epoxy mortar was taken at each repair. If the sample did not cure properly, the contractor would be required to replace the repair. A survey of the repairs placed after the sampling procedure was begun indicated that the tied joints were performing satisfactorily.

The construction of the repairs began in June 1982 and was completed in July of 1983. A photographic sequence of the Department's current construction operation is shown in Appendix B.

Evaluation

All joints included in Stages 1 and 2 and representative samples selected on the Stage 3 project have been instrumented with stainless steel plugs for both horizontal and vertical movement at the joints. In addition, periodic visual inspections are planned to monitor repair performance. With the exception of the failures in the tied joints previously described, measurements and observations to date indicate good performance of both the tied and dowelled joints.

On the average, the contractor constructed the equivalent of 30 to 35, 6-ft repairs per day. Since the repairs were required to be opened to traffic the same day they were cast, concrete placement was normally completed by early afternoon. To obtain this production rate, the contractor had a two-man crew drill the holes and two men to install the tie-bars and dowels.

Of these tasks, it was obvious that the installation of the tie-bars was the most tedious and laborious one. It requires that the work be done very carefully and conscientiously to ensure that the epoxy mortar is proportioned, mixed, and placed properly to ensure satisfactory performance of the tie-bars. By comparison, the insertion of the dowels in the drilled holes is an easy and quick task requiring very little effort and skill.

There are many factors that affect the cost of repairing a concrete pavement. Some of these are: urban or rural project location, light or heavy traffic volumes, two-lane or multilane pavements, large or small number of repairs required, and the volume of other work included with the repair contract work. Because of these factors, it is difficult to establish the amount of the bid price that covers the cost of constructing the experimental repair joints. However, based on the average unit cost for undowelled and nonreinforced repair in 1981, the average unit cost of \$55.32 for the experimental I 94 repairs represented an increase of 18.6 percent.

Conclusions

The successful mechanization of drilling holes rapidly and accurately into the face of an existing concrete slab has made it possible to construct both fixed and sliding joints between a new and an old slab. The specifying of these joints on a contract project did not reduce the production rate, but an increase of about 20 percent in cost over undowelled joint repairs was experienced.

Both types of joints were subjected to traffic the same day they were constructed (minimum concrete flexural strength 300 psi at opening time). Coring and visual inspection of the joints the morning following construction indicated that they can withstand the loadings without any problems. Their long-term performance, estimated to be 10 years, will be monitored on a periodic basis.

The construction of a tied or fixed joint by epoxy mortaring tie-bars into the drilled holes was found to be tedious and labor-intensive. It required careful work with respect to proportioning, mixing, and placing the mortar. If any one of these items is not done correctly, the joint will malfunction.

By comparison, the construction of dowelled joints by drilling 1-3/8-in. diameter holes and inserting 1-5/16-in. dowels in the holes was a simple and easy process. It is evident that the performance of joints containing dowels in such oversize holes is linked to the abrading characteristics of the concrete and the support value of the base. If these conditions are not favorable, reduced performance is to be expected. A few experimental repairs installed in 1972 and utilizing dowels in 1/16-in. oversize holes are still riding smoothly after being subject to an estimated 2.5 million equivalent 18-kip axle loads.

Based on the information from the newly constructed dowelled or tied repair joints and from our 11 year old experimental installations, the Department's standard procedure for repairing concrete pavements now requires the use of dowelled joints. A copy of current specifications and standard plan is included in Appendix C.

It should be noted that the use of dowelled repair joints does not, in itself, ensure good and lasting repair performance. It has been observed that the following requirements are very important to obtain satisfactorily performing repairs:

- 1) All limits of the repairs are sawed full-depth with a diamond bladed saw. This ensures a full-depth sound concrete section to resist future compressive forces.
- 2) The continuity of the existing base is maintained. This is accomplished by lifting out the distressed concrete sections and cleaning out the area with hand tools.
- 3) The concrete must have a minimum flexural strength of 300 psi at time of opening to traffic with the concrete gaining strength at such a rate that a minimum 3,500 psi compressive strength is reached in about 24 hours after concrete placement. These requirements on concrete strengths are primarily obtained by controlling the concrete slump and the amount of flake calcium chloride added to the mix at the job site.
- 4) Immersible type vibrators are used to consolidate the concrete. In addition, a vibratory screed is used to strike-off the surface, and as a final check to ensure proper surface smoothness, the repair is measured with a straightedge.
- 5) The joint grooves are sandblasted to obtain better adhesion of the hot-poured rubber-asphalt sealant to the groove walls. This should prolong the sealant's ability to prevent contamination of the joints which will help to increase the length of the repair's performance.

APPENDIX A
SPECIAL PROVISIONS AND PLANS FOR
I 94 EXPERIMENTAL CONTRACT REPAIRS

38101 (18171A)
I 94 Jackson County

Dowelled Joint Repair from Calhoun-Jackson County Line Easterly
Approximately 14 Miles to Airport Rd.

SPECIAL NOTICE

Prospective bidders are advised that the construction of these concrete pavement repairs will require the design and fabrication of a machine for drilling dowel and tie-bar holes in the hardened concrete. The specification for such a machine is given in the Special Provisions in this proposal.

A pre-bid meeting will be held at 10:00 a.m. on May 7, 1982 at the Testing and Research Laboratory Building in the Secondary Governmental Complex. The purpose of this meeting will be to discuss the work, materials, and specifications concerning the construction of dowelled joint repairs. Also, a prototype of a drilling machine will be available for inspection by interested bidders.

MICHIGAN
DEPARTMENT OF TRANSPORTATION

SPECIAL PROVISION
FOR
FULL DEPTH REPAIRS WITH TIED ENDS AND
A DOWELLED TYPE X EXPANSION JOINT

Scope.-This work includes all labor, equipment, and materials required to construct a full depth repair in nominal 9-inch concrete pavement using reinforced Type FS concrete with tied end joints and a dowelled Type X expansion joint.

All work and materials shall be in accordance with the 1979 Standard Specifications, Special Detail Sheet II-44E, and Special Detail - Joint Repair Sheet, with the exceptions and additions provided herein.

The location and size of the repairs shall be as shown in the proposal, on the plans, or as determined by the Engineer.

Removal of Old Pavement.-Removal of old pavement shall be as specified in the Standard Specifications and Special Detail Sheet II-44E, except that the two end limit saw cuts shall be performed in such a manner as to create a 1/4 inch \pm 1/16 inch wide step at approximately 4-1/2 inches below the pavement surface in the face of the concrete which is to remain in place. This shall be accomplished by mounting one or more smaller diameter saw blades adjacent to the large blade used for full depth cuts.

End Ties - Installation.-The ends of each lane patch shall be tied to the existing pavement by embedding seven 20 inch long No. 6 deformed bars 8 inches into the existing pavement. The method of embedment shall consist of machine drilling seven 1-3/8 inch diameter holes 8 inches deep into the face of the existing pavement at the locations and slope shown on the Special Detail - Joint Repair Sheet. The holes shall be cleaned with dry, oil-free compressed air prior to embedding the bar. The bar shall be embedded in epoxy mortar consisting of approximately 3 parts of dry masonry sand to 1 part (by volume) of Type II epoxy binder as specified in Standard Specification 8.16.05. The holes shall be filled with sufficient mortar to insure that when the bar is inserted the cavity around the bar will be completely filled.

Hole Drilling - Requirements.-The use of hand-held drills will not be permitted. The holes shall be drilled with a drilling machine meeting the following minimum requirements:

The machine used to drill the holes in the face of the existing pavement shall be capable of drilling 1-3/8 in. diameter holes 8 inches deep at approximately 4-1/2 inches below the pavement surface. The machine must have the ability to drill parallel to the pavement surface \pm 1/8 inch

and perpendicular to the length of the saw cut $\pm 1/8$ inch as well as at a slope of approximately minus 10 degrees with the surface. The forward and reverse travel of the drill shall be controlled by mechanically applied pressure. The drill equipped with carbide bits and the pressure mechanism shall be matched to drill the 8 inch deep hole in 45 seconds or less without causing excessive spalling or cracking of the concrete.

The drill and pressure mechanism shall be mounted on a track system so that it can move transversely across the width of the lane. It shall be capable of being securely locked to the track at the specified hole locations.

The drilling machine shall be mounted on a tractor or other suitable piece of equipment so that it can be easily transported from repair to repair and quickly positioned at each repair.

Load Transfer Assembly - Installation.-The load transfer assembly shall be in accordance with Standard Specification 8.16.10 and Standard Plan II-40D, except that the filler shall be 7-1/2 inches in height. A temporary form strip 1-1/2 inches deep and 1 inch wide, meeting the requirements of Standard Specification 4.52.04, shall be temporarily attached to the top of the filler to form the joint groove. To facilitate removal of the form, the width of the form may be tapered from 1-1/4 inch at the top to 1 inch at the bottom.

The assembly shall be installed so that the top of the temporary form is flush with the surface of the repair at both edges.

Reinforcement - Placement.-All repairs regardless of length shall be steel reinforced. The reinforcement shall be supported during concrete placement by bar chairs or other means approved by the Engineer. For repairs where the distance from the end of the repair to the center of the load transfer assembly is 6 foot or less, the wire fabric reinforcement shall be positioned so that the heavy wires are parallel to the load transfer assembly. When the distance from the end of the repair to the center of the load transfer assembly is greater than 6 foot, the reinforcement shall be placed in the conventional manner.

Lane Ties.

Expansion Anchored Lane Ties.-For repairs over 12 foot in length expansion anchored lane ties meeting the requirements of Subsection 8.16.12 shall be installed at repairs when the new concrete is poured against the existing longitudinal pavement edge and in accordance with the requirements of Subsection 4.50.10. The spacing shall be as shown on Standard Plan II-41D, except the first lane tie adjacent to a transverse joint shall be installed at a distance of 20 inches from the joint.

Hook Bolt Lane Ties.-For repairs over 12 foot in length hook bolt lane ties meeting the requirements of Subsection 8.16.12 shall be installed

at repairs when both lanes are being replaced, and in accordance with the requirements of Subsection 4.50.10. The spacing shall be as shown on Standard Plan II-41D, except the first hook bolt adjacent to a transverse joint shall be installed at a distance of 20 inches from the joint.

Concrete Placement and Finishing.-Type FS concrete shall be placed, finished, and cured as specified in Standard Specification 4.52.

Prior to texturing, an edger with a 1/8 to 1/4 inch radius shall be run along both edges of the temporary form to radius the edge of the concrete at the joint. The temporary form shall be removed as soon as the concrete has gained sufficient strength to allow removal without spalling the concrete.

Joint Groove Preparation and Sealing.-The joint groove shall be prepared and sealed as specified in Standard Specification 4.52 and on Special Detail Sheet II-44E.

Shoulder Replacement.-The shoulder shall be restored as directed in Standard Specification 4.52.

Method of Measurement.-Measurement for Expansion Anchored Lane Ties will be for each assembly installed as specified in Standard Specification 4.50.24.

Measurement for Hook Bolt Lane Ties will be for each assembly installed.

Measurement for Removing Old Pavement (Patching) will be as specified in Standard Specification 4.52.05.

Measurement for Concrete Pavement Patching will be as specified in Standard Specification 4.52.05.

Measurement for Fixed Costs for Patches (Type X) will be as specified in Standard Specification 4.52.05.

Basis of Payment.-Payment for EXPANSION ANCHORED LANE TIES will be for each assembly installed as specified in Standard Specification 4.50.24 and will include the cost of furnishing and installing the anchor and hook bolt.

Payment for HOOK BOLT LANE TIES will be for each assembly installed and will include the cost of furnishing and installing the assembly.

Payment for REMOVING OLD PAVEMENT (PATCHING) will be in accordance with Standard Specification 4.52.05.

Payment for CONCRETE PAVEMENT PATCHING, TYPE FS, REINFORCED will be in accordance with Standard Specification 4.52.05.

Payment for FIXED COSTS FOR PATCHES (TYPE X) will be in accordance with Standard Specification 4.52.05 with the following exception:

The first paragraph below the listing of pay items under Subsection 4.52.05 is hereby deleted and replaced with the following paragraph:

Fixed Costs for Patches (Type X) will be measured as units for the number of patches placed in each lane of pavement. Payment for FIXED COSTS FOR PATCHES (TYPE X) includes payment for the portion of the work of constructing a patch which is not directly related to the length of the patch such as: transverse sawing including the step cuts, drilling the slant holes for the end ties, furnishing and installing the epoxy mortar and end ties, furnishing and installing the load transfer assembly, forming and preparing the joint groove, furnishing and installing the hot-poured sealant, and moving equipment.

SPECIAL TYPE X EXPANSION JOINT DETAIL SHEET
 FOR
 FULL DEPTH REPAIRS WITH TIED ENDS AND
 A DOWELLED TYPE X EXPANSION JOINT

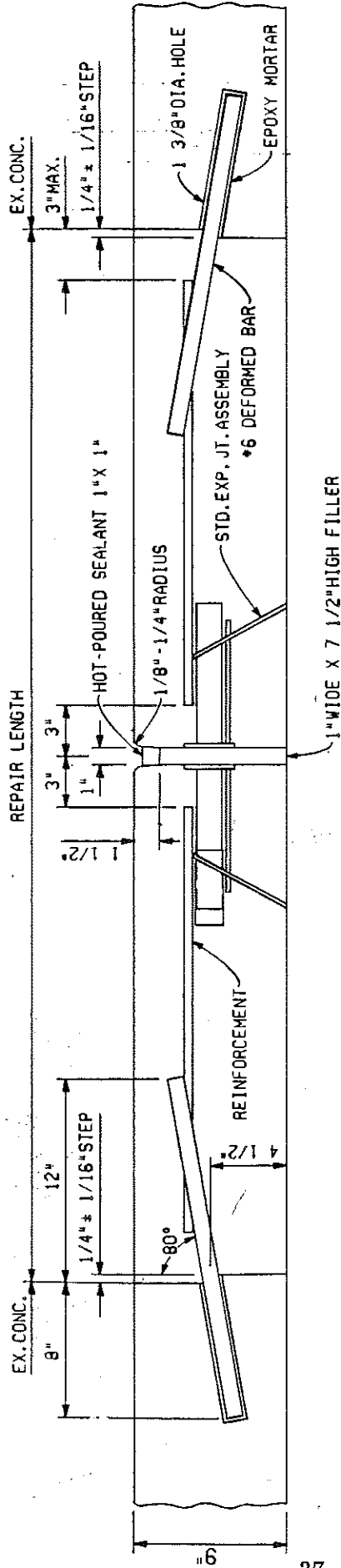

DEFORMED BAR SPACING

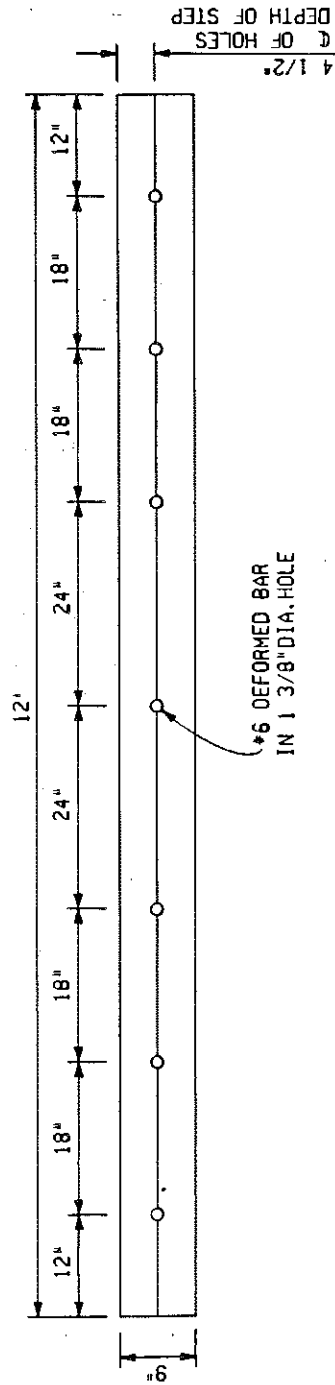

NOTE: THE HOLE SPACING MAY BE ADJUSTED 1" HORIZONTALLY,
 RAISED 1/2", OR LOWERED 1" FROM THE ABOVE LOCATIONS
 TO AVOID DRILLING INTO THE REINFORCEMENT.

MICHIGAN
DEPARTMENT OF TRANSPORTATION

SPECIAL PROVISION
FOR
FULL DEPTH REPAIRS WITH
DOWELLED TYPE Y CONTRACTION JOINTS

Scope.-This work includes all labor, equipment, and materials required to construct a full depth repair in nominal 9-inch concrete pavement using steel reinforced Type FS concrete with dowelled Type Y contraction joints.

All work and materials shall be in accordance with the 1979 Standard Specifications, Special Detail Sheet II-44E, and Special Detail - Joint Repair Sheet, with the exceptions and additions provided herein.

The location and size of the repairs shall be as shown in the proposal, on the plans, or as directed by the Engineer.

Removal of Old Pavement.-Removal of old pavement shall be as specified in the Standard Specification and Special Detail Sheet II-44E.

Dowel Bar Requirements.-The ends of each lane patch shall be dowelled to the existing pavement with the use of 1-5/16 inch diameter dowel bars 15 inches in length with at least one sawed end. The dowel bars shall be straight, smooth, round bars with a minimum yield strength of 40,000 psi and a minimum tensile strength of 70,000 psi. The cylindrical surface of the dowel bar shall be coated with a durable, exterior type, rust inhibitive paint. The application of a bond-breaking coating is not required.

Dowel Bar - Installation.-The ends of each lane repair shall be dowelled to the existing pavement by machine drilling nine 1-3/8 inch diameter holes 7-1/2 inches deep into the existing pavement at the locations shown on the Special Detail - Joint Repair Sheet. The holes shall be parallel to the surface of the pavement $\pm 1/8$ inch and perpendicular to transverse saw cut $\pm 1/8$ inch. The construction and requirements for the drilling machine shall be as specified in the Special Provisions for Full Depth Repairs with Tied Ends and a Dowelled Type X Expansion Joint.

Prior to inserting the dowel bars, the holes shall be cleaned with compressed air to remove all debris.

Reinforcement - Placement.-All repairs regardless of length shall be steel reinforced. The reinforcement shall be supported during concrete placement by bar chairs or other means approved by the Engineer. For repairs less than 6 foot in length, the wire fabric reinforcement shall be positioned so that the heavy wires are parallel to the end of the repair. For repairs longer than 6 foot, the reinforcement shall be placed in the conventional manner.

Lane Ties.

Hook Bolt Lane Ties.-For repairs over 12 foot in length hook bolt lane ties meeting the requirements of Subsection 8.16.12 shall be installed at repairs when both lanes are being replaced, and in accordance with the requirements of Subsection 4.50.10. The spacing shall be as shown on Standard Plan II-41D, except the first hook bolt adjacent to a transverse joint shall be installed at a distance of 20 inches from the joint.

Concrete Placement and Finishing.-Type FS concrete shall be placed, finished, and cured as specified in Standard Specification 4.52. A temporary form conforming to the requirements of Standard Specification 4.52.04 shall be positioned at each end of the repair to form a joint groove 1-1/2 inches deep and 1 inch wide.

To facilitate the removal of the form, the form may be tapered from a width of 1-1/4 inches at the top to 1 inch at the bottom.

Prior to texturing, an edger with a 1/8 to 1/4 inch radius shall be run along the edge of the temporary form to radius the edge of the concrete. The temporary form shall be removed after the concrete has gained sufficient strength to allow removal without spalling the concrete.

Joint Groove Preparation and Sealing.-The joint groove shall be prepared and sealed as specified in Standard Specification 4.52 and on Special Detail Sheet II-44E. A bond breaker, consisting of a pressure-sensitive silicone-backed tape or equivalent shall be required in the bottom of the joint groove.

Shoulder Replacement.-The shoulder shall be restored as directed in Standard Specification 4.52.

Method of Measurement.-Measurement for Hook Bolt Lane Ties will be for each assembly installed.

Measurement for Removing Old Pavement (Patching) will be as specified in Standard Specification 4.52.05.

Measurement for Concrete Pavement Patching will be as specified in Standard Specification 4.52.05.

Measurement for Fixed Costs for Patches (Type Y) will be as specified in Standard Specification 4.52.05.

Basis of Payment.-Payment for HOOK BOLT LANE TIES will be for each assembly installed and will include the cost of furnishing and installing the assembly.

Payment for REMOVING OLD PAVEMENT (PATCHING) will be in accordance with Standard Specification 4.52.05.

Payment for CONCRETE PAVEMENT PATCHING, TYPE FS, REINFORCED, will be in accordance with Standard Specification 4.52.05.

Payment for FIXED COSTS FOR PATCHES (TYPE Y) will be in accordance with Standard Specification 4.52.05 with the following exception:

The first paragraph below the listing of pay items under Subsection 4.52.05 is hereby deleted and replaced with the following paragraph:

Fixed Costs for Patches (Type Y) will be measured as units for the number of patches placed in each lane of pavement. Payment for FIXED COSTS FOR PATCHES (TYPE Y) includes payment for the portion of the work of constructing a patch which is not directly related to the length of the patch such as: transverse sawing, drilling the holes for the dowel bars, furnishing and installing the dowel bars, forming and preparing the joint groove, furnishing and installing the bond-breaker and hot-poured sealant, and moving equipment.

SPECIAL TYPE Y CONTRACTION JOINT DETAIL SHEET
 FOR
 FULL DEPTH REPAIRS WITH
 DOWELLED TYPE Y CONTRACTION JOINT

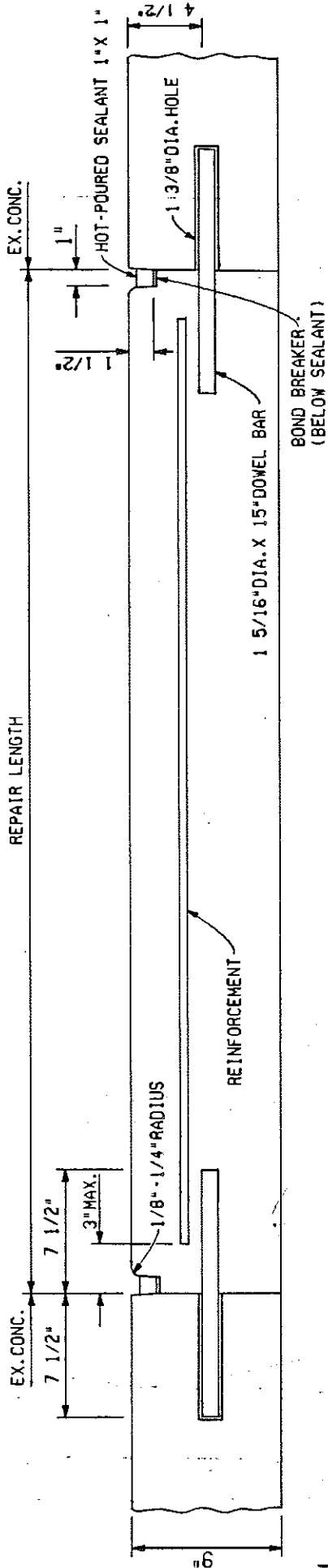

DOWEL BAR SPACING

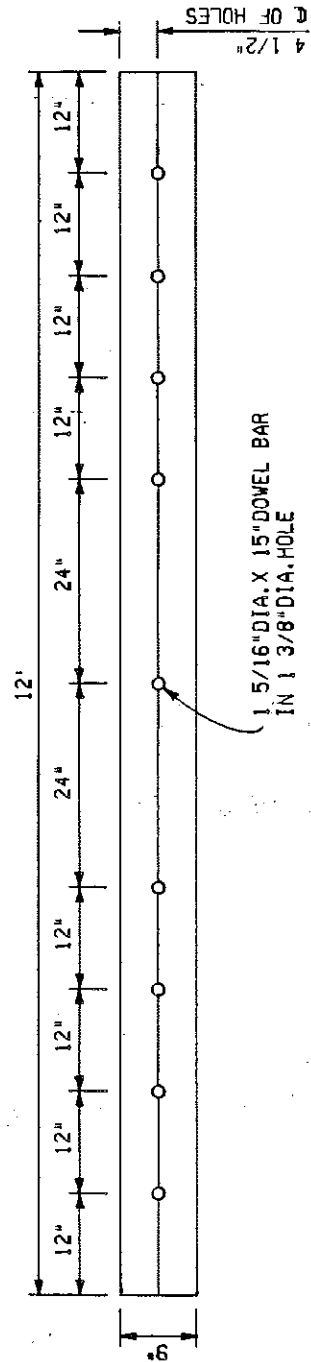

NOTE: THE HOLE SPACING MAY BE ADJUSTED HORIZONTALLY,
 RAISED 1/2", OR LOWERED 1" FROM THE ABOVE LOCATIONS
 TO AVOID DRILLING INTO THE REINFORCEMENT.

APPENDIX B
PHOTOGRAPHIC SEQUENCE OF
CONSTRUCTION OPERATIONS

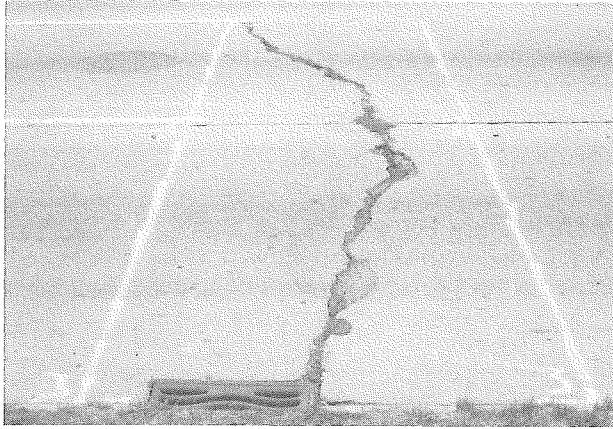

◀ Figure 1b. Limits of repair marked on pavement either by painting or by snapping a chalk line.

Figure 2b. Transverse end limits are sawed full-depth using a 65 hp saw equipped with a 26-in. diameter diamond blade. ▶

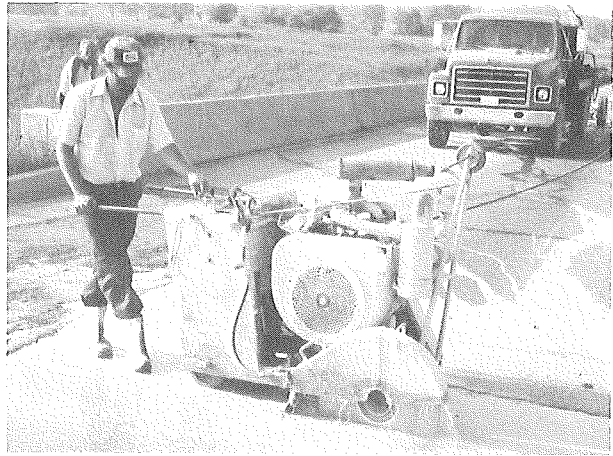

◀ Figure 3b. The longitudinal joint is also sawed full-depth.

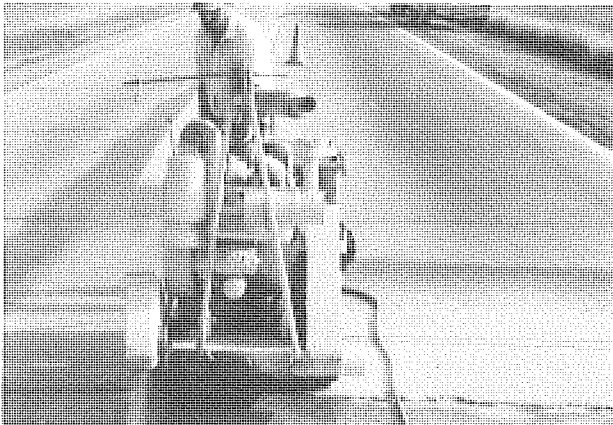
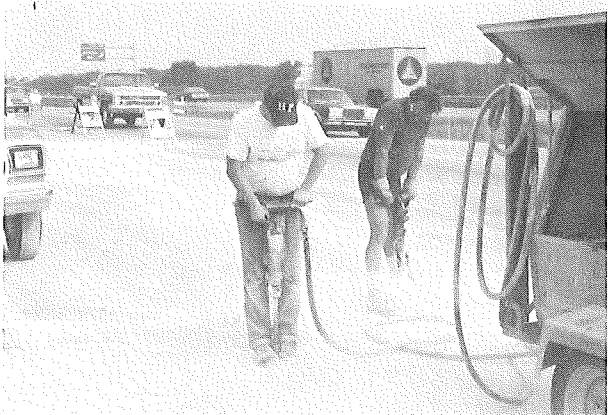

Figure 4b. Holes are drilled through the slab so that lift pins can be inserted. ▶



◀ Figure 5b. Lift pin holes should be located in sound concrete within the repair area. Note double saw cuts at right end limit.



Figure 6b. The concrete between the double saw cuts has been removed to relieve compression in the slab. ▶



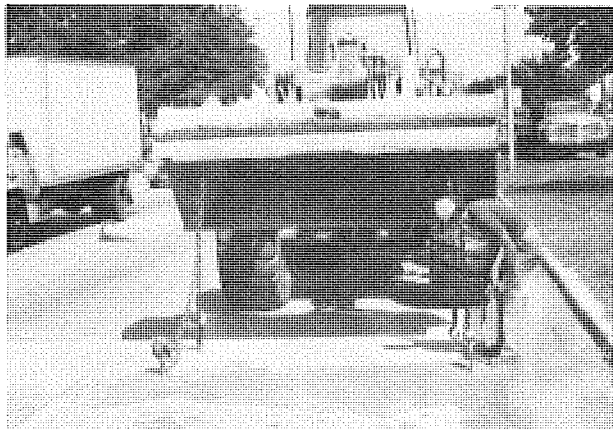

Figure 8b. The distressed concrete area is lifted out without disturbing the base.

Figure 7b. Installing lift pins and attaching chains to front-end loader.

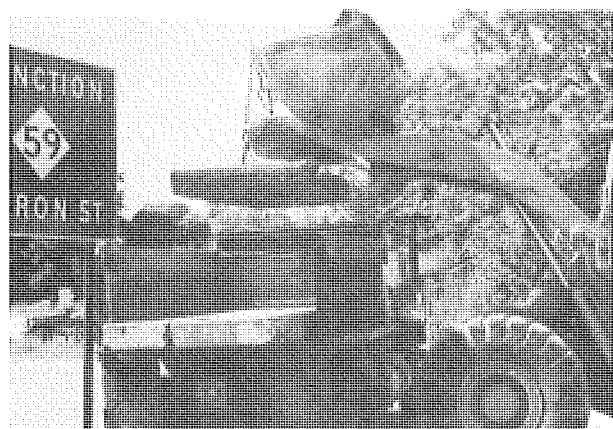

Figure 10b. Final clean-out of the area must be done by hand tools to prevent base damage.

Figure 9b. The broken concrete pieces are loaded on a truck and transported to disposal site.

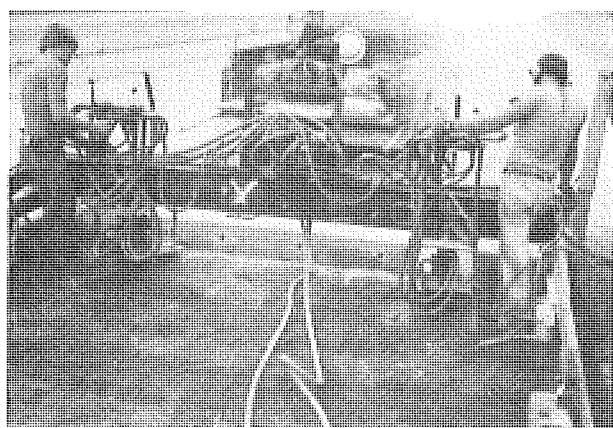
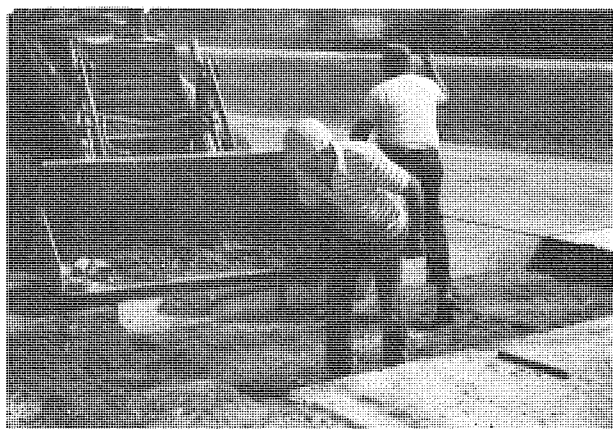
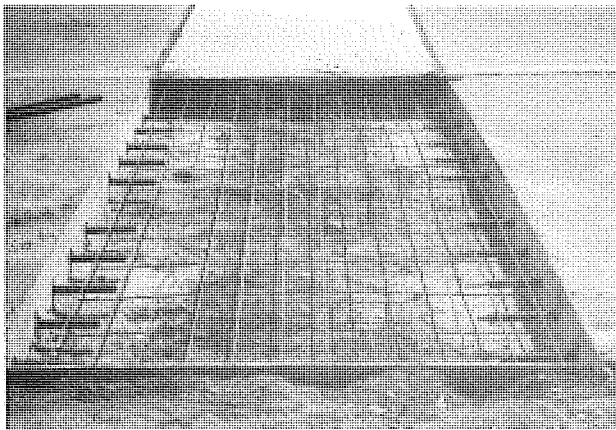

Figure 12b. Dowel holes are cleaned by using compressed air.

Figure 11b. Holes for dowels (1-3/8-in. diam) are machine-drilled. Hand-held drills are not permitted.





◀ Figure 13b. Contraction joint with forms, dowels, and reinforcement in place.

Figure 14b. To ensure that the holes in expansion joint filler boards fit over the dowels, the holes are marked on the filler using pointed locating pins. Holes sawed by use of a standard hole saw. ▶

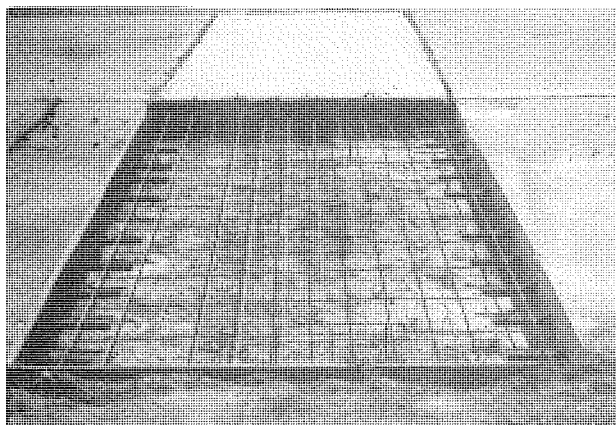
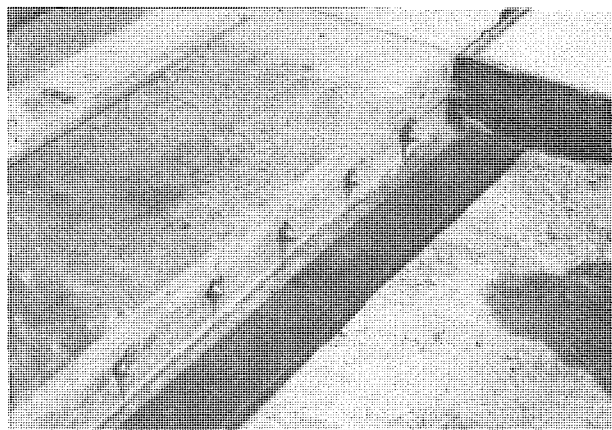

◀ Figure 15b. Expansion joint repair. Filler and groove forming strip at left side.

Figure 16b. The replacement concrete consists of a 9-sack mix with flake calcium chloride added at the job site just prior to pouring. The use of calcium chloride allows the concrete to attain required strength (300 psi, flexural) in four to eight hours. ▶

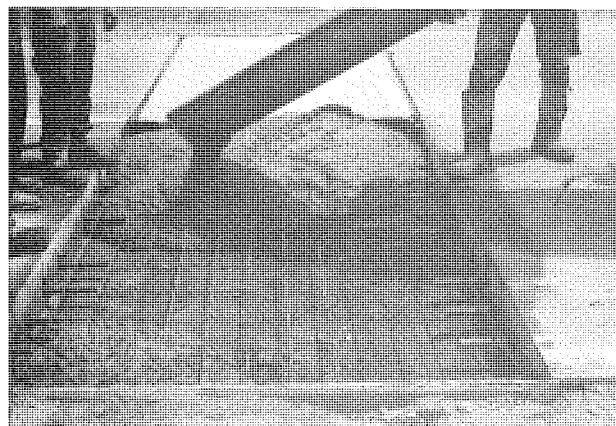

◀ Figure 17b. The replacement concrete must meet the specified slump requirement to ensure that the strength can be obtained within the specified time limit.

Figure 18b. Once the concrete is cast, groove forming wood strips are inserted in the concrete. ▶





◀ Figure 19b. Consolidation of the concrete must be done by use of immersion-type vibrators.

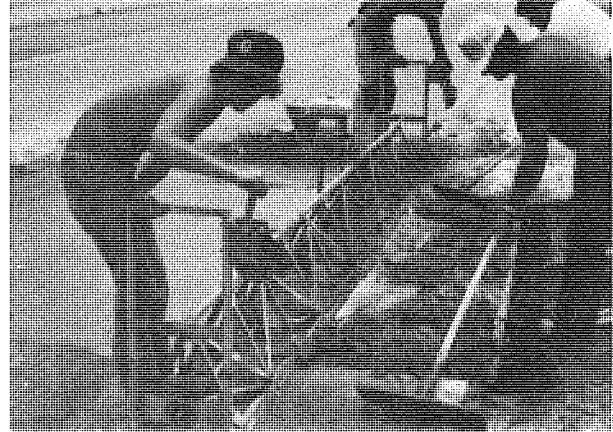

▶ Figure 20b. The concrete must be struck-off using a vibrating screed. At least two passes must be made.



◀ Figure 21b. The surface of the concrete is finished by hand floating.



▶ Figure 22b. The limits of the repair are edged.



◀ Figure 23b. The surface is textured by using a coarse broom.

▶ Figure 24b. Prior to the concrete gaining its initial set, the groove forming strips are removed.





Figure 26b. The joint grooves are cleaned by sand blasting and compressed air prior to sealing.



Figure 28b. A hot-poured rubber-asphalt sealant is installed in the joint grooves.

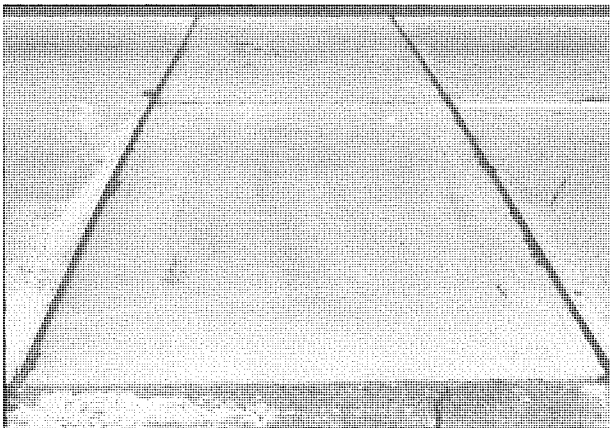

Figure 30b. Completed portion of 14-mile long repair project. A total of 2,700 repairs were made.

Figure 25b. A membrane curing compound is applied to the surface of the repair. When the temperature is below 65 F, curing blankets are used.



Figure 27b. A tape is installed in the bottom of contraction joint grooves to prevent the sealant from bonding to the bottom of the groove.



Figure 29b. A completed joint repair slab.



APPENDIX C

MDOT CURRENT SPECIFICATIONS AND
PLANS FOR CONCRETE PAVEMENT REPAIR

MICHIGAN
DEPARTMENT OF TRANSPORTATION

SUPPLEMENTAL SPECIFICATION
FOR
CONCRETE PAVEMENT REPAIR

4.52(1c)

Section 4.52 of the 1979 Standard Specifications is hereby deleted and replaced with the requirements contained herein.

All references to Sections and Subsections herein are references to the 1979 Standard Specifications.

4.52 CONCRETE PAVEMENT REPAIR

4.52.01 Description. - This work shall consist of repairing portions of a concrete pavement with portland cement concrete with or without reinforcement, as required, and with the type of joint specified.

The use of the word "pavement" in a general sense shall be understood to include concrete base course and concrete shoulders.

The type or grade of concrete required will be determined by the Engineer based on the time allowed from the casting of the repair to the intended opening of the repair to traffic. The type or grade of concrete required will be as follows:

From Casting to Intended Opening to Traffic	Grade or Type of Concrete
8 hours	Type P-FS concrete
24 hours	Type P-MS concrete
3 days	Grade 35HE concrete
7 days or longer	Grade 35P concrete

4.52.02 Materials. - The materials shall meet the requirements specified in the Sections designated as follows:

Concrete, Grade 35HE, Grade 35P	7.01
Concrete Repair Mixture, Type P-FS, Type P-MS	7.03
Bituminous Materials for Restoring Bituminous Shoulders	7.10
Base Course Aggregate, 22A.	8.02
Steel Reinforcement	8.05
Joint Materials	8.16
Curing Materials for Pavements.	8.24

Type P-FS and Type P-MS Concrete Mixtures. - Type P-FS and Type P-MS concrete mixtures shall meet the requirements specified in Section 7.03 with the modifications specified herein.

Concrete mixtures using certain combinations of cement brands and types and concrete admixtures sometimes do not provide the strength required within the time specified. The Contractor shall select brands of cement and admixtures which will provide the required strength within the specified time.

The Consistency (Slump) range specified in Table 7.03-1 in Section 7.03 is hereby changed from "2-4" to "1-3" inches; the second sentence in the note below Table 7.03-1 is hereby replaced with the following sentence: "For ready-mixed concrete, the initial water shall be adjusted such that the

concrete mixture will have the slump specified immediately prior to adding the flake chloride; only 77 percent grade flake calcium chloride will be allowed as a strength accelerator."

For Type P-MS mixtures, flake calcium chloride shall be added when the air temperature is below 65 F. For temperatures ranging from 65 F to 45 F, the chloride shall be added at the rate of 9 pounds per cubic yard and for temperatures below 45 F, the chloride shall be added at the rate of 18 pounds per cubic yard. The calcium chloride shall be added to the mixture at the job site prior to placement.

All references to continuous mixed concrete in Tables 7.03-1 and 7.03-2 are hereby deleted.

Materials for Forming Joint Grooves. - Materials used to form joint grooves for seals shall be of continuous, one-piece, rigid, smooth materials which will form smooth and uniform grooves of the sizes specified for the joint seals; styrofoam, or similar material, is not suitable.

Bond Breaker. - The bond breaker for the joint sealant shall be a pressure-sensitive silicone-backed tape, or equivalent, meeting the approval of the Engineer.

Dowel Bars. - Dowel bars shall be straight, smooth, round bars with a minimum yield strength of 40,000 psi and a minimum ultimate tensile strength of 70,000 psi, having both ends sawed, and of the dimensions shown on the plans. The cylindrical surface of the dowel bars shall be shop coated with a durable, exterior type, rust-inhibitive paint.

Expansion Caps. - Expansion caps shall be fabricated in accordance with the details shown on the plans.

4.52.03 Equipment Requirements. - The following equipment, provided as needed for the type of repair placed, shall meet the requirements specified under Concrete Pavement, 4.50, and as specified herein.

a. Concrete Saw. - The concrete saw shall be equipped with a diamond blade, or approved equal. The saw blade shall be of sufficient size to saw pavements full depth for the depth of repair specified in the pay item.

b. Equipment and Devices for Removing Old Concrete Slabs.

c. Vibratory Compactor.

d. Forms, Metal or Wood. - For repairs 12 feet or less in length, forms shall be one piece. For repairs over 12 feet in length, the forms shall lock together, or shall be spliced, to provide a continuous form. Nominal 2-inch thick lumber shall be used for wooden forms.

e. Drilling Machine. - The machine used to drill the holes in the face of the existing pavement shall be capable of drilling 1 3/8-inch diameter holes 8 1/2-inches \pm 1/2-inch deep at approximately mid-pavement depth. The machine shall produce holes which are perpendicular (\pm 1/8-inch per 8 1/2-inches of depth) to the face of the transverse saw cut. The forward and reverse travel of the drill shall be controlled by mechanically applied pressure. The drill and the pressure mechanism shall be matched to drill the nominal 8 1/2-inch deep holes without cracking the concrete and without causing spalls in excess of 1/2-inch horizontally and 1-inch vertically. A drill guide bushing will be required to be positioned at the concrete face to prevent eccentricity of the drilled hole.

f. Internal Vibrator.

g. Vibratory Screed.

- h. Straightedges. - The Contractor shall provide 6 1/2-foot, 8 1/2-foot, and 10 1/2-foot straightedges.
- i. Pressure Hand Sprayer for Membrane Curing Compound.
- j. Insulating Blankets.

CONSTRUCTION METHODS

4.52.04 General. - Construction methods shall be as specified under Concrete Base Course and Pavement, 4.50, except as modified herein.

The repairs shall be made in accordance with the details shown on the plans and at the locations shown on the plans and/or log sheets, or as directed by the Engineer. The Engineer will not require repairs to be shorter than 6 feet. When the area to be repaired leaves a slab adjacent to a joint, or the next area to be repaired, shorter than 6 feet, the Engineer will require that section to be removed also.

To minimize distress in the lane adjacent to the lane being repaired, the Contractor shall schedule the removal and recasting of concrete repairs in the lane adjacent to the lane being repaired on the succeeding work day after the repair is opened to traffic, unless otherwise approved by the Engineer.

4.52.05 Removing Existing Pavement:

a. Removing Pavement. - Sections of pavement to be removed which are over 50 feet in length shall be removed in accordance with the requirements specified in Section 2.07 or as specified herein under Removing Pavement (Repair), 4.52.05-b.

b. Removing Pavement (Repair). - Sections of pavement to be removed which are 50 feet or less in length shall be removed as specified herein. Removing Pavement (Repair) consists of the sawing, removal, and disposal of sections of the existing pavement as specified on the plans, in the proposal, or as directed by the Engineer.

Pavement that is to remain in place but has been spalled by the Contractor in the removal operations shall be repaired as follows: Isolated minor spalls as defined in Subsection 4.50.19-a that are less than 10 square inches shall be filled with hot-poured joint sealant. Isolated minor spalls 10 square inches and over, numerous minor spalls in the same joint area, intermediate spalls as defined in Subsection 4.50.19-b, and major spalls as defined in Subsection 4.50.19-c, shall be repaired by resawing. The new saw cuts shall be located to be in line with or at least two feet from the end of the adjacent repair. Such additional saw cuts and the additional concrete required for the repair will be at the Contractor's expense.

Where the portion of pavement to be removed includes part-depth or full-depth bituminous patches, removal of the bituminous patches will be considered as removal of concrete, without regard to any additional effort which may be involved in the removal of dissimilar materials. Removal shall be such as to avoid disturbing the base.

Where the area to be repaired includes concrete shoulders, the removal of the shoulders shall be accomplished in a manner similar to the removal of the pavement and in accordance with the plans.

Where the area to be repaired includes the repair of curbing (concrete curb, curb and gutter, or valley gutter), the Contractor shall remove the curbing adjacent to the repair and in line with the joints in the repair, except that if the curbing removed results in an adjacent free and unconnected length of curbing of less than 6 feet between the saw cut and the nearest existing joint in the curbing, the Contractor shall also remove this short

length of curbing, constructing the joint at that location instead of in line with the joint in the repair.

The concrete shall be sawed full depth, in multiple passes within the same 12-hour period or in one pass, in accordance with the details shown on the plans or in the proposal. Transverse saw cuts shall be made at a right angle to the centerline of the pavement, within a tolerance of 1.0 inch. The centerline joint shall be sawed full depth. The sawing operations shall not precede the removal operations by more than 2 weeks, unless otherwise approved by the Engineer. The concrete shall not be removed until the day the repair is placed. Concrete between narrowly spaced saw cuts at the end of a slab shall be removed with air hammers and hand tools. Lifting devices shall be installed and the slab lifted without disturbing the base. The area shall then be cleaned out with hand tools.

4.52.06 Installing Dowels in Transverse Joints. - Where doweled joints are required for transverse joints, the faces of the existing pavement shall be drilled with a machine to allow the insertion of the dowel bars. Where drilling machines are removed before all holes are drilled to the proper depth, redrilling to proper depth will be required.

Because rather large tolerance on dowel bar spacings is allowed to prevent drilling into the reinforcement, the dowel holes in the filler cannot be pre-punched. Therefore, it is required that at each expansion joint location, the holes in the filler must match the holes drilled in the existing concrete face.

The length of the filler shall be equal to the nominal width of the lane. It shall be installed in one continuous piece, except that a short piece may be used to fill a gap resulting from the pavement being wider than the nominal lane width.

Each drilled hole shall be cleaned with compressed air. Unless other methods are approved by the Engineer, the following procedure shall be used to install the dowels and filler:

The holes shall be drilled or punched in the filler in such a manner as to produce neat clean holes without tearing the filler material around the holes.

The filler shall be placed against the concrete face and the dowels fully inserted through the filler into the drilled holes without tearing or distorting the filler material.

For expansion joints, a liquid asphalt coating meeting requirements of RC-250 shall be uniformly applied to the portion of the dowel which will be in the new concrete. The dowel bar may be coated prior to installing it in the drilled hole, provided that the coating is clean and intact at the time of the placing the dowel cap. The dowel bar may be coated with a gloved hand after installing it in the drilled hole and prior to placing the dowel cap, provided that the coating is sufficiently dry before the concrete is cast. Thinning of the RC-250 will not be allowed.

For expansion joints, the expansion cap shall be placed on the end of each protruding dowel, after the dowel is coated with RC-250 asphalt and prior to the placement of the concrete.

Alternate Procedure. - In lieu of expansion caps to fit the 1 5/16-inch diameter bars, the following alternative materials and procedures may be used:

A 1 1/4-inch diameter by 1 to 1 1/8-inch long foam plug shall be fully inserted into the holes with the cylindrical surface of the plug

parallel to the length of the hole. The foam material shall be an approved closed cell, expanded polyethylene foam rod with a density of 2.3 ± 0.4 lb/cu ft.

The dowels shall be inserted through the filler and into the holes until they lightly rest against the end of the foam plug. The application of RC-250 coating is not required for this method.

The polyethylene foam plugs will be inspected prior to use to ensure that they conform to the above specifications. In addition, prior to placing the concrete, each dowel will be inspected to ensure that the polyethylene foam plugs have been properly installed.

4.52.07 Site Preparation. - Where base corrections occur, excavation and backfill shall be done as specified under Roadway Earthwork, 2.08. A low base condition in excess of 2 inches which existed prior to removal of the concrete shall be corrected by adding base course aggregate and thoroughly compacting to proper elevation. Any low base condition which is caused by the Contractor's operation and any low base condition not exceeding 2 inches shall be filled with concrete when the repair is constructed.

Forms shall be set to the proper line and grade.

For undoweled expansion joints, the expansion joint filler shall be placed against the existing pavement as shown on the plans, for the full width of the joint. The length of the filler shall be equal to the nominal width of the lane. It shall be installed in one continuous piece, except that a short piece may be used to fill a gap resulting from the pavement being wider than the nominal lane width.

4.52.08 Pavement Reinforcement. - Where pavement reinforcement is required, the reinforcement shall be supported during concrete placement by the use of bar chairs, except that the dowels may be used for supporting the ends of the reinforcement.

For repairs up to and including 8 feet in length, the wire fabric reinforcement shall be positioned so that the larger diameter wires are perpendicular to the pavement centerline. For repairs longer than 8 feet, the reinforcement shall be placed with the larger diameter wires parallel to the pavement centerline. The wire size and spacing of the wires shall be as specified on the plans.

Reinforcing bars may be omitted from curb repairs.

4.52.09 Longitudinal Joints. - Where more than one lane is cast in a single pour, longitudinal joints shall be constructed in line with the existing longitudinal joints and to a depth of one-fourth the thickness of the pavement, either by sawing before opening to traffic or by forming; an external longitudinal joint is not required between concrete pavement repairs and concrete curbing or shoulders.

Lane ties shall be installed in accordance with the plans.

4.52.10 Transverse Joints. - Transverse joints in pavement, shoulders, and curb repairs shall be of the type shown on the plans. Where existing curbs are to be left in place and expansion space is provided in the adjacent lane repair, an Expansion Joint Esc shall be constructed by sawing and chipping. The width of the joint shall be equal to the sum of the widths of the joints in the adjacent lane repair. The joint shall be constructed in line with one of the repair joints. The bituminous joint filler material shall be shaped to fit the specified curb cross section.

4.52.11 Placing Concrete. - Unless otherwise permitted by the Engineer, concrete shall be placed the same day that the existing pavement is removed.

Each repair shall be cast in one continuous full-depth operation. The concrete shall be consolidated by use of a hand-held immersion-type vibrator. Special attention shall be given to consolidating the concrete around dowel bars.

When Type P-FS concrete repair mixture is specified, the placement operations shall be scheduled such that all repairs utilizing the repair mixture from a common batch shall be completed within 20 minutes after the addition of the calcium chloride to the batch. The quantity of calcium chloride to be added shall be as specified in Table 7.03-2 and by the methods described in Subsection 7.03.05-b. Water shall not be added to the concrete after chloride is added.

Temporary forms for forming the expansion and contraction joint grooves shall be 1 inch wide and 1 1/2 inches deep. The expansion joint groove shall be formed by positioning the temporary form on top of the filler. The contraction joint groove shall be formed by inserting the temporary form after concrete placement. Spalling caused by late removal of these forming strips shall be repaired with approved material.

4.52.12 Finishing Requirement. - The surface shall be struck off flush with the existing pavement surface at least twice with the vibratory screed. Floating in lieu of striking off with a screed will not be acceptable. For repairs 12 feet or less in length, the screed shall be placed parallel to the centerline of the roadway. For repairs over 12 feet in length, the screed shall be placed perpendicular to the centerline.

While the concrete is still plastic, the Contractor shall test the repair surface for trueness and for being flush with the edges of the repair by use of a straightedge and in accordance with the following:

For repairs 10 feet or less in length, the straightedging shall be done by placing the straightedge parallel to the pavement centerline with the ends resting on the existing pavement and drawing the straightedge across the repair. The straightedging of 6-, 8-, and 10-foot repairs shall be accomplished by use of a straightedge not exceeding the length of the repair by more than 6 inches. The straightedge shall be in contact with the existing pavement while drawing it across the repair and any high or low spots exceeding 1/8 inch shall be corrected. If any corrections are made, the Contractor shall recheck the surface and eliminate irregularities.

For repairs over 10 feet in length, the straightedging shall be done in accordance with Subsection 4.50.13, except that the first and the last measurement shall be made with approximately half of the straightedge resting on the existing pavement, and the second and the next to last measurement shall each be made with 2 to 3 inches of the straightedge resting on the existing pavement. Any irregularities in excess of 1/8 inch in 10 feet shall be corrected.

Prior to texturing, an edger with a 1/8- to 1/4- inch radius shall be run along the entire periphery of the repair to round the edge of the concrete. The temporary forms shall be removed after the concrete has gained sufficient stiffness to allow removal of the forms without the concrete sagging or spalling.

4.52.13 Texturing. - The surface of the repair shall be textured transversely to the pavement centerline by use of a coarse broom.

4.52.14 Stenciling. - The month and the year shall be stenciled in each repair in accordance with Subsection 4.50.15.

4.52.15 Curing. - Concrete curing compound shall be applied as soon as the concrete surface has set sufficiently to apply the curing agent without damage.

For concrete pavement repairs made with type P-FS concrete or type P-MS concrete, when the air temperature during the curing period falls below 65 F, insulation blankets having a minimum thickness of 2 inches shall be placed over the repaired area as soon as the curing compound has been applied. Edges and seams in the blanket shall be secured to prevent penetration of wind. Test beams shall be cured the same as the repair. Curing blankets may be removed when the concrete has attained a flexural strength of 300 psi for Type P-FS concrete and 500 psi for Type P-MS concrete.

4.52.16 Cleaning Joints. - All concrete remaining on top of the filler in the expansion joint shall be removed prior to sandblasting. All joints shall be sandblasted and then cleaned with oil free compressed air immediately prior to sealing. A bond breaker consisting of a pressure-sensitive silicone-backed tape or equivalent shall be placed in the bottom of the contraction joint groove after the final cleaning and prior to sealing.

4.52.17 Sealing Joints. - Longitudinal bulkhead joints and joints in base course repairs need not be constructed with reservoirs for seals and need not be sealed. All other joints and all sawcuts which were made in pavements, shoulders, or gutters by overcutting, shall be sealed with hot-poured sealant.

4.52.18 Bituminous Shoulder Replacement. - Prior to opening to traffic, bituminous shoulders shall be restored to the existing line and grade using a plant-mixed bituminous mixture. Cold patch mixtures used for temporary patching shall be replaced with plant-mixed bituminous mixtures, unless shoulder reconstruction is a part of the project. The bituminous material shall be compacted by mechanical or hand methods suitable for the size hole being filled. The voids shall be filled and compacted flush with the surrounding shoulder. Bituminous plant mixtures shall be placed at a temperature suitable for compaction.

Materials removed from the shoulder shall be disposed of by the Contractor.

4.52.19 Opening to Traffic. - The concrete repairs may be opened to traffic when the new concrete has attained a flexural strength of 300 psi for repairs constructed with Type P-FS concrete, 500 psi for repairs constructed with Type P-MS concrete, and 550 psi for repairs constructed with Grade 35HE or Grade 35P concrete. Traffic may be allowed over the repair prior to sealing the joints.

MEASUREMENT AND PAYMENT

4.52.20 Measurement and Payment. - The completed work as measured for CONCRETE PAVEMENT REPAIR will be paid for at the contract unit prices for the following contract items (pay items), except that pavement repairs which have been cored and found to be deficient in depth and/or with reinforcement improperly located will be paid for at an adjusted unit price as provided under Concrete Base Course and Pavement, 4.50.24.

<u>Pay Item</u>	<u>Pay Unit</u>
Moving from Repair to Repair	Each
Removing Pavement.	(See Section 2.07)
Removing Pavement (Repair)	Square Yard
Adjusting Drainage Structure Covers.	(See Section 5.14)
Intermediate Saw Cuts.	Linear Foot
Concrete Pavement Repair, ___ in., Nonreinforced	Square Yard
Concrete Pavement Repair, ___ in., Reinforced.	Square Yard
Cement	(See Section 4.50)
Contraction Joint Cr	Linear Foot
Expansion Joint Er	Linear Foot
Expansion Joint Esc.	Linear Foot
Undoweled Joint Ur	Linear Foot
Plane-of-Weakness Joint D1	(See Section 4.50)
Lane Ties, Pavement Repair	Each
Calcium Chloride	Pounds

The item, Moving from Repair to Repair, includes the cost of relocating all the necessary materials, labor, and equipment from repair site to repair site. If more than one lane is repaired in one operation, it will be considered as one operation. The moving of labor, material, and equipment to the first repair site and removing the same from the project is considered as part of the item of Mobilization in accordance with Section 6.23.

The item Removing Pavement will apply to sections of pavement to be removed which are over 50 feet in length and where the prohibitions against disturbing the base will not apply. The work will be measured and paid for in accordance with Section 2.07.

The item Removing Pavement (Repair) applies to sections of pavement to be removed which are 50 feet or less in length. The work includes the removal of adjacent concrete shoulders, curb, curb and gutter, and valley gutter; the removal of areas of concrete pavement having part-depth or full-depth bituminous patches; lifting the section out without disturbing the base; and loading, hauling, and disposing of the material removed.

The item Adjusting Drainage Structure Covers includes the salvaging of the cover, resetting the cover including any minor repairs of the masonry needed, and furnishing and placing steel reinforcement as shown on the plans. Such work will be measured and paid for in accordance with Section 5.14.

The item Intermediate Saw Cuts only applies to sections of pavement where the item Removing Pavement (Repair) applies; it does not apply to sections of pavement where the item Removing Pavement applies. Payment for the cost of making intermediate saw cuts to remove a section of a pavement lane which is over 6 feet in length, if required to permit loading onto the hauling unit, will be measured by length in linear feet of pavement sawed, and paid for at the contract unit price bid for Intermediate Saw Cuts. Intermediate saw cuts need not be full depth, but shall be of sufficient depth such that the concrete can be removed by lifting without disturbing the base. Additional saw cuts made at the option of the Contractor to reduce 6-foot by 12-foot slabs into smaller pieces will not be paid for separately.

Concrete Pavement Repair, Nonreinforced, of the thickness specified, and Concrete Pavement Repair, Reinforced, of the thickness specified, will be measured by area in square yards. Longitudinal measurements for area will be made along the actual surface of the roadway. Transverse measurement shall be the dimension shown on the plans or in the proposal. Payment for Concrete

Pavement Repair includes payment for furnishing, placing, finishing, and curing the concrete; furnishing and placing the steel reinforcement, where reinforcement is required; furnishing any additional concrete required to correct low base conditions which do not exceed 2 inches in depth, and the furnishing and placing of any bituminous material necessary to restore the shoulders to the existing line and grade. The depth of the repair specified in the pay item is considered the average depth of concrete that will be required for the repairs. The pay-item depth is based on the plan thickness originally specified for the existing concrete pavement plus 1 inch. It is expected that the depth of concrete placed in the repairs will not vary more than ± 1 inch from the pay-item depth.

Where the time from the casting of the repair area to the intended opening to traffic requires the use of faster setting concrete mixtures (Grade 35HE, Type P-MS, or Type P-FS mixtures), the Contractor, in addition to the square yards of concrete pavement repair placed, will be paid for extra cement. The cement will be measured by weight in tons and paid for as specified in Subsection 4.50.24 on the following basis: 94 pounds per cubic yard will be paid for where Grade 35HE concrete is required, and 282 pounds per cubic yard will be paid for where Type P-MS or Type P-FS concrete is required.

The repair of shoulders, curbs, and/or gutters will be measured in square yards and paid for as Concrete Pavement Repair, Nonreinforced, and of the same thickness as the adjacent pavement repair. Expansion Joint Esc will be measured by length in linear feet. Payment for the joint includes the cost of sawing and chipping the joint in the type of curb specified and furnishing and installing the joint filler material.

Contraction Joint Cr, Expansion Joint Er, and Undoweled Joint Ur will be measured by length in linear feet. Payment for the joint includes the cost of making the saw cuts required at the ends of the repairs; drilling holes for dowel bars; furnishing and installing the dowel bars; forming or sawing and preparing the joint groove; furnishing and installing the bond breaker and joint sealant; and for expansion joints the payment also includes the cost of furnishing and applying the RC-250 asphalt coating; furnishing and installing the dowel caps or foam plugs; and furnishing, drilling or punching, and installing the expansion joint filler. The sawing included in this item is for the pay-item repair depth; depths encountered in excess of 1 inch over the pay-item repair depth will be paid for as extra work.

Transverse Plane-of-Weakness Joints D1, required in concrete pavement repairs, will be measured and paid for as specified in Section 4.50. Transverse Plane-of-Weakness Joints U, required in concrete base course repairs, will not be paid for separately but will be considered to have been included in the payment for Concrete Pavement Repair.

Where Lane Ties, Pavement Repair are specified, the lane ties will be paid for as units. The contract unit price includes the cost of furnishing and installing the lane ties.

Where Calcium Chloride is required to be added to the concrete mixture, it will be measured by weight in pounds of 77 percent flake chloride required to be added. For Type P-FS concrete, the pay quantity of chloride will be determined in accordance with the requirements of Table 7.03-2. For Type P-MS concrete, the pay quantity of chloride will be determined in accordance with the requirements specified herein under Subsection 4.52.02. The pay quantity will be the number of sacks used times the nominal weight indicated on the sacks.

Calcium Chloride used for base stabilization will not be paid for separately.

Payment for additional aggregate required for correction of low base conditions exceeding 2 inches, which existed prior to pavement removal, will be paid for in cubic yards of Aggregate-Base Patching as specified under Subsection 4.03.04.

Any work of final trim and clean-up, part-width construction, and restoration of shoulders will not be paid for separately.

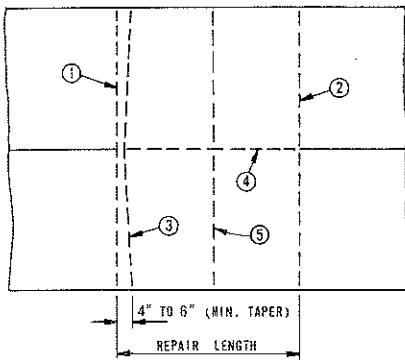

Plan of Sawing Diagram

① & ②

THIS METHOD OF REMOVING DISTRESSED CONCRETE SHALL BE USED IN CONJUNCTION WITH FULL DEPTH CAST-IN-PLACE REPAIRS (DETAILS 3 & 3A) LESS THAN 50' LONG, AND IS OPTIONAL FOR REPAIRS OVER 50' IN LENGTH.

③

THESE SAW CUTS SHALL BE FULL DEPTH AND PERPENDICULAR TO THE EDGE OF THE ROADWAY, WITHIN A TOLERANCE OF 1". THIS FULL DEPTH SAW CUT IS MADE TO FACILITATE OPENING A TRENCH ACROSS THE SLAB TO RELIEVE COMPRESSION IN THE PAVEMENT PRIOR TO LIFTING OUT THE FAILED AREA. THIS SAW CUT MAY BE OMITTED PROVIDED NO SPALLING OF THE REMAINING CONCRETE PAVEMENT OCCURS. IF SPALLING DOES OCCUR, THE CONTRACTOR WILL BE REQUIRED TO MAKE THIS SAW CUT ON SUBSEQUENT REPAIRS.

④

THIS SAW CUT IS MADE FULL DEPTH BETWEEN LANES, BETWEEN A LANE AND A CURB, AND BETWEEN A LANE AND A RAMP.

⑤

IF REQUIRED, INTERMEDIATE SAW CUTS MAY BE MADE TO REMOVE A SECTION OF PAVEMENT LANE WHICH IS OVER 6 FEET IN LENGTH, TO PERMIT LOADING INTO THE HAULING UNITS.

ADDITIONAL SAW CUTS, AT CONTRACTOR'S EXPENSE, MAY BE MADE INSIDE THE REPAIR LIMITS TO REDUCE 6-FOOT BY 12-FOOT SLABS INTO SMALLER PIECES TO FACILITATE REMOVAL.

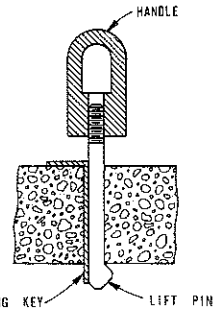

Schematic of Typical Lift Pin Assembly

SAWING DIAGRAM & LIFT PIN FOR REMOVING OLD SLAB

DETAIL 1

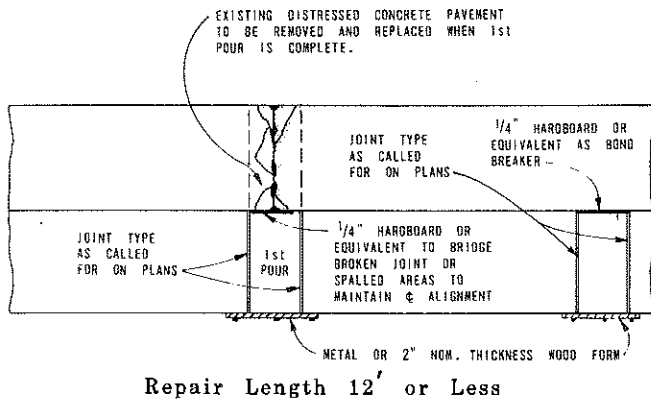

Repair Length 12' or Less

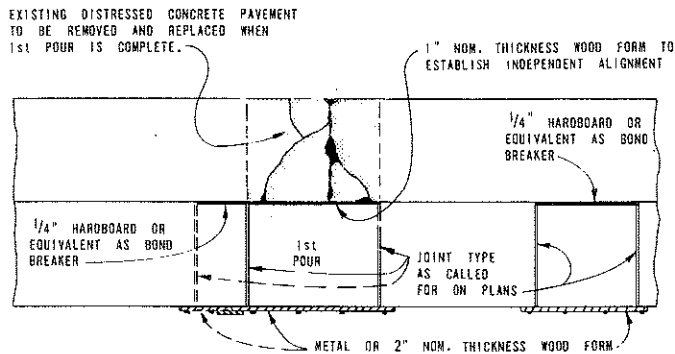

Repair Length More Than 12'

NOTE: STAKES USED TO HOLD BITUMINOUS FILLER OR HARDBOARD IN PLACE DURING CONCRETE PLACEMENT SHALL BE REMOVED BEFORE SCREEDING THE CONCRETE.

FORMING REQUIREMENTS FOR CAST-IN-PLACE REPAIR

DETAIL 2

PREPARED BY DESIGN DIVISION	ENGINEER OF CONSTRUCTION	ENGINEER - ROAD DESIGN
	ENGINEER OF MAINTENANCE	ENGINEER OF DESIGN
	ENGINEER OF TESTING AND RESEARCH	DEPARTMENT DIRECTOR JAMES P. PITZ
	ENGINEER OF TRAFFIC AND SAFETY	DEPUTY DI
DRAWN BY: H.A.W.		
CHECKED BY: V.R.		

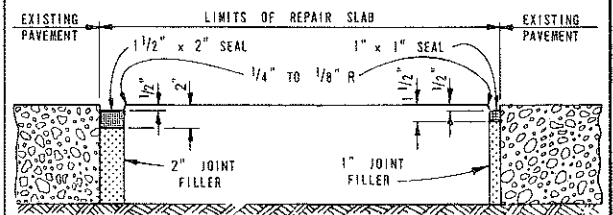

Expansion Joint Type "A"

Expansion Joint Type "B"

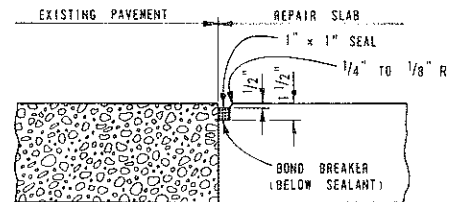

Contraction Joint Type "C"

NOTE: WHEN PLACING CONCPETE PAVEMENT REPAIRS IN CONCRETE PAVEMENTS WITH BITUMINOUS OVERLAYS, THE REPAIR SHALL BE CONSTRUCTED AS SHOWN ABOVE EXCEPT THE SURFACE OF THE CONCRETE REPAIR SHALL BE CONSTRUCTED LEVEL WITH THE TOP OF THE EXISTING BITUMINOUS SURFACE.

UNDOWELED CAST-IN-PLACE REPAIR JOINTS U_r

DETAIL 3

MICHIGAN DEPARTMENT OF TRANSPORTATION
 BUREAU OF HIGHWAYS STANDARD PLAN FOR
CONCRETE PAVEMENT REPAIR

W.A. APPROVAL	11-22-83 PLAN DATE	II-44F	SHEET 1 OF 4
---------------	-----------------------	--------	--------------

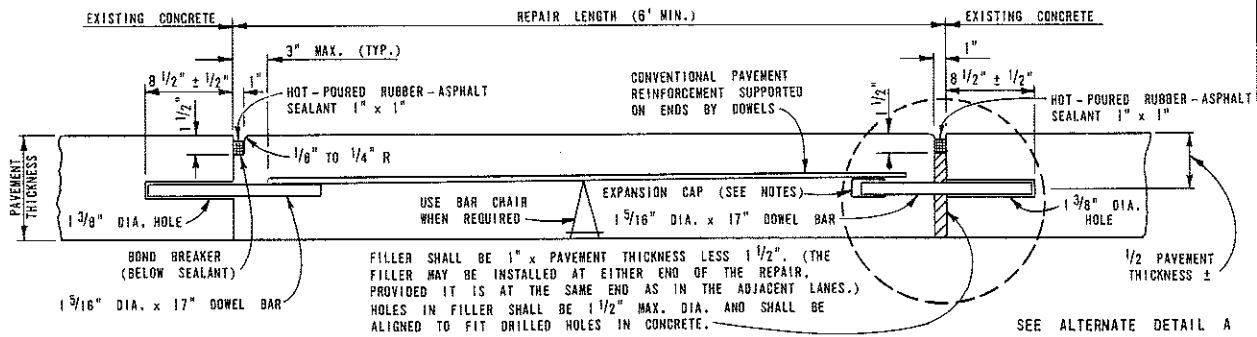

CONTRACTION JOINT Cr

EXPANSION JOINT Er

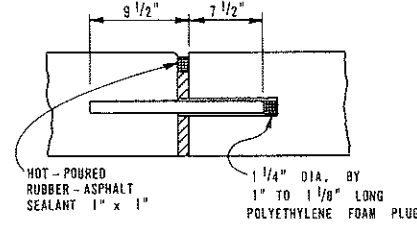
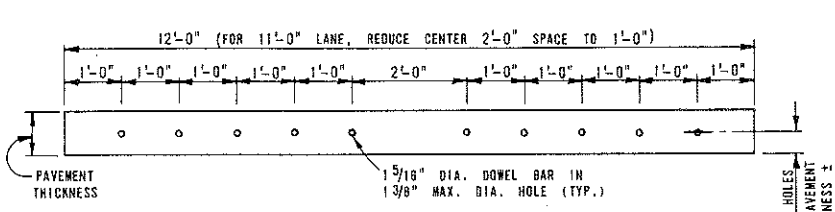

ALTERNATE DETAIL A

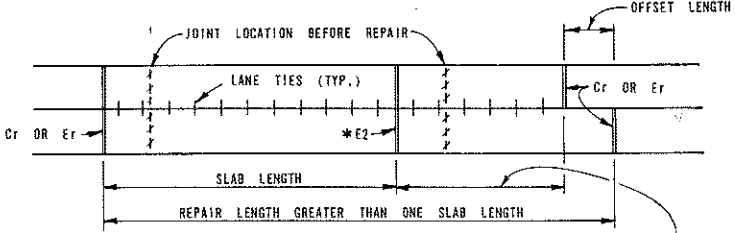
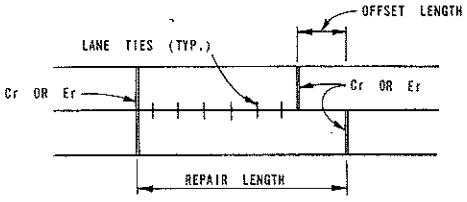

NOTE: OMIT ALL LANE TIES IF THE REPAIR LENGTH IS LESS THAN 20', OR IF OFFSET LENGTH BETWEEN LANES IS GREATER THAN 3'.

* WHEN THERE IS MORE THAN ONE INTERIOR JOINT, MAKE OTHERS C2.

OMIT ALL LANE TIES IF OFFSET LENGTH IS GREATER THAN 3'.

Repair Length Less Than One Slab Length

Repair Length Greater Than One Slab Length

(Two-Lane Repairs)

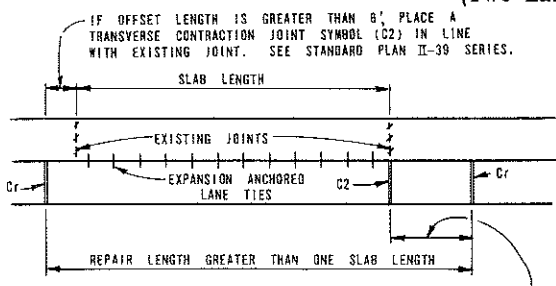

NOTES:
 LONGITUDINAL LANE TIES, WHEN REQUIRED, SHALL BE SPACED IN ACCORDANCE WITH STANDARD PLAN II-41 SERIES, EXCEPT THE FIRST LANE TIE ADJACENT TO A TRANSVERSE JOINT SHALL BE INSTALLED AT A DISTANCE OF 1'-8".
 EXPANSION CAPS SHALL BE FABRICATED FROM A MINIMUM 28 GAGE SHEET STEEL AND SHALL BE SIZED SO AS TO PROVIDE A SLIP FIT ON THE SHOP PAINTED DOWEL BAR. THE EXPANSION CAP SHALL CONTAIN A SINGLE LONGITUDINAL TIGHTLY ROLLED "S" SEAM, WITH A SUITABLE STOP TO MAINTAIN THE END OF THE CAP A MINIMUM DISTANCE OF 1" FROM THE END OF THE DOWEL DURING CONCRETE PLACEMENT AND TO PROVIDE A MINIMAL EXPANSION RESISTANCE FOR SUBSEQUENT MOVEMENT OF THE BAR IN THE CAP. THE EXPANSION CAP SHALL BE COMPLETELY CLOSED AT THE END BY CRIMPING AND SHALL BE OF A UNIFORM DIAMETER FOR A MINIMUM LENGTH OF 4". A SAMPLE OF EACH DESIGN OF EXPANSION CAP SHALL BE SUBMITTED TO THE ENGINEER OF TESTING AND RESEARCH ALONG WITH A SHOP DRAWING FOR APPROVAL PRIOR TO USE. CAPS MADE OF OTHER MATERIALS AND/OR DESIGNS, IF TESTED AND APPROVED BY THE ENGINEER, MAY BE USED AT THE OPTION OF THE CONTRACTOR.
 A BOND-BREAKING COAT OF LIQUID ASPHALT (MDOAT RC-250) IS REQUIRED ON THE PORTION OF THE DOWEL BAR EXTENDING INTO THE NEW CONCRETE WHEN EXPANSION CAPS ARE USED.

Repair Length Greater Than One Slab Length (One-Lane Repairs)

LANE TIES FOR DOWELED REPAIRS

DOWELED CAST-IN-PLACE REPAIR JOINTS

DETAIL 3A

<p>PREPARED BY DESIGN DIVISION</p> <p>DRAWN BY: H.A.W.</p> <p>CHECKED BY: V.R.</p>	ENGINEER OF CONSTRUCTION	ENGINEER - ROAD DESIGN	MICHIGAN DEPARTMENT OF TRANSPORTATION BUREAU OF HIGHWAYS STANDARD PLAN FOR CONCRETE PAVEMENT REPAIR	II-44F	SHEET 2 OF 4
	ENGINEER OF MAINTENANCE	ENGINEER OF DESIGN			
	ENGINEER OF TESTING AND RESEARCH	DEPARTMENT DIRECTOR JAMES P. FITZ			
	ENGINEER OF TRAFFIC AND SAFETY	BY: DEPUTY DIRECTOR			
			11-22-83		
			A. APPROVAL	PLAN DATE	

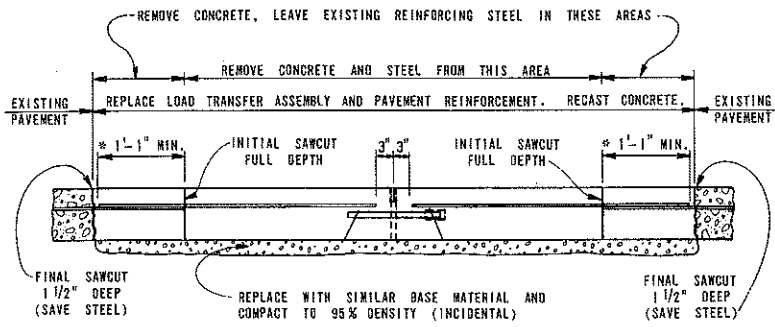

* NOTE:
IF EXISTING REINFORCEMENT LAPS ARE ENCOUNTERED IN THIS AREA, FINAL SAW CUT MUST BE MOVED BACK TO PROVIDE MINIMUM 1'-1" LAP OF PAVEMENT REINFORCEMENT.

TRANSVERSE JOINT REPAIR USING LOAD TRANSFER ASSEMBLY

DETAILS
(CONTRACTION JOINT) 4
(EXPANSION JOINT) 4A

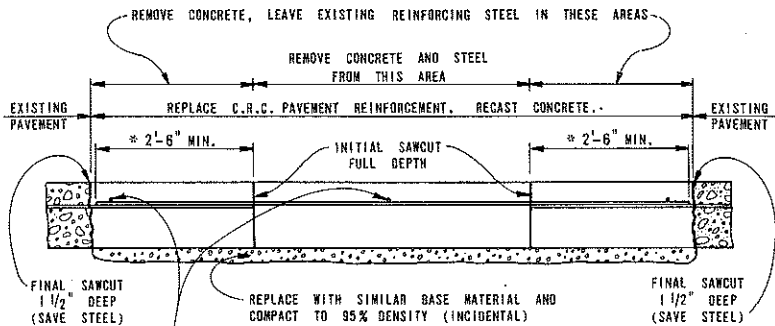

* NOTE:
IF EXISTING REINFORCEMENT LAPS ARE ENCOUNTERED IN THIS AREA, FINAL SAW CUT MUST BE MOVED BACK TO PROVIDE MINIMUM 2'-6" LAP OF PAVEMENT REINFORCEMENT.

REPAIRING CONTINUOUSLY REINFORCED CONCRETE

DETAIL 5

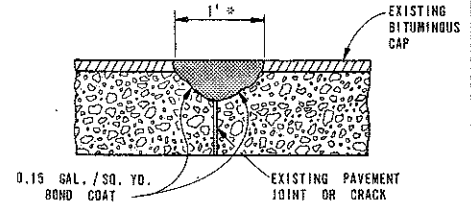

1. STRIP OFF EXISTING GAP AND REMOVE LOOSE DETERIORATED CONCRETE.
2. REPLACE BITUMINOUS CAP AND LOOSE DETERIORATED CONCRETE WITH BITUMINOUS MIXTURE NO. 1100, 1300, OR 1500 AND COMPACT WITH A MACHINE VIBRATOR OR APPROVED ROLLER. THE COMPACTED BITUMINOUS MIXTURE SHALL BE FLUSH WITH EXISTING BITUMINOUS CAP.

* FOR QUANTITY ESTIMATE PURPOSES ONLY

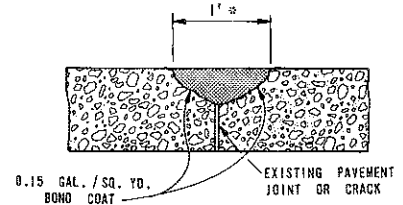

1. WHERE NO BITUMINOUS CAP EXISTS, REMOVE LOOSE DETERIORATED CONCRETE.
2. REPLACE LOOSE DETERIORATED CONCRETE WITH BITUMINOUS MIXTURE NO. 1100, 1300, OR 1500 AND COMPACT WITH A MACHINE VIBRATOR OR APPROVED ROLLER. THE COMPACTED BITUMINOUS MIXTURE SHALL BE FLUSH WITH EXISTING CONCRETE PAVEMENT.

* FOR QUANTITY ESTIMATE PURPOSES ONLY

TRANSVERSE OR LONGITUDINAL JOINT OR CRACK REPAIR

DETAIL 7

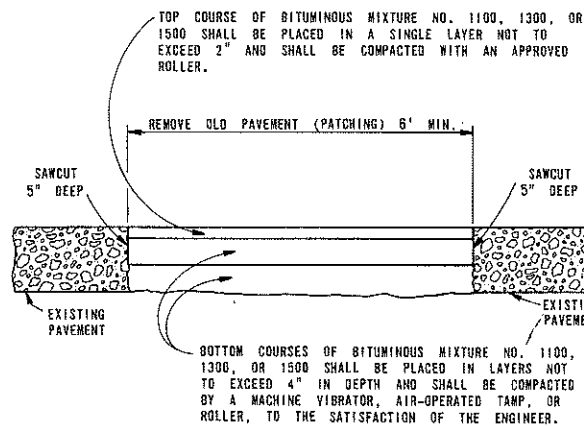

REPAIRING WITH BITUMINOUS MATERIAL

DETAIL 6

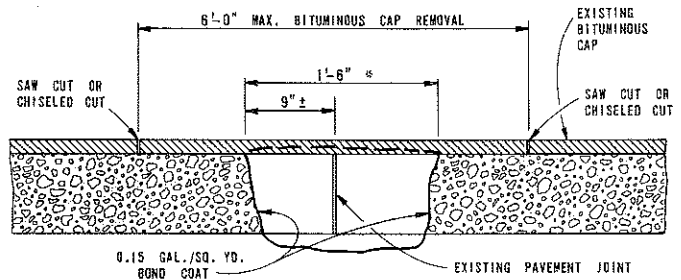

1. STRIP OFF EXISTING BITUMINOUS CAP AND BREAK OUT EXISTING CONCRETE PAVEMENT.
2. REPLACE BROKEN-OUT AREA WITH BITUMINOUS MIXTURE NO. 1100, 1300, OR 1500 AND COMPACT WITH WHEELED OR VIBRATORY EQUIPMENT.
3. REPLACE BITUMINOUS CAP WITH BITUMINOUS MIXTURE NO. 1100, 1300, OR 1500 AND COMPACT WITH APPROVED ROLLER. THE COMPACTED BITUMINOUS MIXTURE SHALL BE FLUSH WITH ADJACENT PAVEMENT SURFACE.

* FOR QUANTITY ESTIMATE PURPOSES ONLY

TRANSVERSE JOINT REPAIR

DETAIL 8

 PREPARED BY DESIGN DIVISION	ENGINEER OF CONSTRUCTION	ENGINEER - ROAD DESIGN
	ENGINEER OF MAINTENANCE	ENGINEER OF DESIGN
	ENGINEER OF TESTING AND RESEARCH	DEPARTMENT DIRECTOR JAMES P. FITZ
	ENGINEER OF TRAFFIC AND SAFETY	DEPUTY DI
DRAWN BY: H.A.W.		
CHECKED BY: V.R.		

MICHIGAN DEPARTMENT OF TRANSPORTATION BUREAU OF HIGHWAYS STANDARD PLAN FOR		
CONCRETE PAVEMENT REPAIR		
A. APPROVAL	11-22-83 PLAN DATE	II-44F
		SHEET 3 OF 4

ORIGINAL CORNERS BROKEN OUT.
FILL VOIDS WITH CONCRETE.
INCIDENTAL TO THE WIDENING.

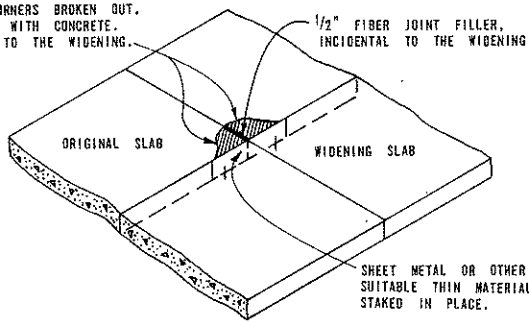

JOINT PATCH ADJACENT TO WIDENING SLAB

DETAIL 9

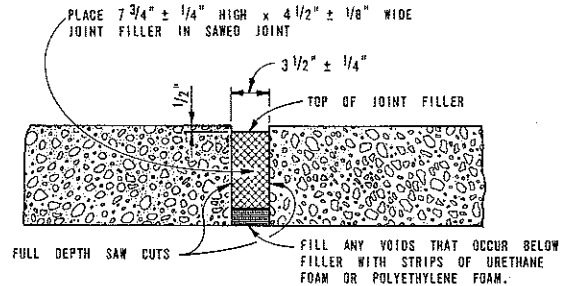

NOTE: WHEN PRESSURE RELIEF JOINT IS TO BE CONSTRUCTED THROUGH 6" CONCRETE SHOULDER, TRENCH BELOW CONCRETE 2" ± TO ALLOW ROOM FOR 7/8" FILLER.

PRESSURE RELIEF JOINT
(THIS DETAIL ALSO APPLIES TO BITUMINOUS SURFACED PAVEMENTS REQUIRING PRESSURE RELIEF JOINTS)

DETAIL 10

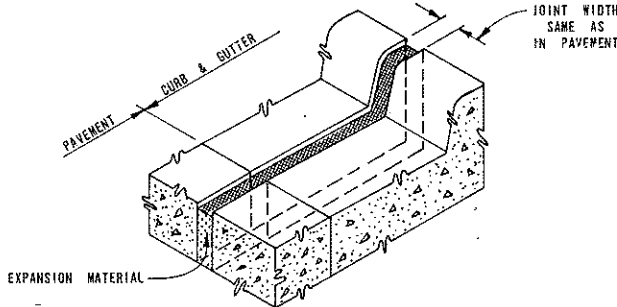

CURB, GUTTER AND CURB FACE SHALL BE SAWS AS DEEP AS THE EXISTING PAVEMENT THICKNESS. THE REMAINING CONCRETE SHALL BE CHIPPED OUT AND EXPANSION MATERIAL OF SUFFICIENT THICKNESS SHALL BE PLACED IN SAWS JOINT TO FILL THE GAP AS DIRECTED BY THE ENGINEER.

EXPANSION JOINT Esc

DETAIL 11

NOTES APPLYING TO STANDARD PLAN II-44F:

CONCRETE PAVEMENT REPAIRS OR PRESSURE RELIEF JOINT DETAILS WILL BE AS CALLED FOR ON PLANS OR IN LOG OF PROJECT.

IF EXISTING PAVEMENT HAS AN ASPHALT SURFACE, THE SAW CUTS SHALL EXTEND THRU THE UNDERLYING PORTLAND CEMENT CONCRETE.

WHEN CONCRETE PAVEMENT REPAIRS ARE TO BE RESURFACED, REINFORCEMENT WILL BE OMITTED. IF THE REPAIR IS LONGER THAN 20', TRANSVERSE PLANE OF WEAKNESS JOINTS, SYMBOL (U), SHALL BE PLACED IN LINE WITH EXISTING TRANSVERSE JOINTS, WORKING CRACKS, OR AT 20-FOOT MAX., 6-FOOT MIN. INTERVALS. FOR SYMBOL (U) JOINTS, SEE STANDARD PLAN II-39 SERIES.

WHEN REPAIRING PAVEMENTS WITH CAST-IN-PLACE REPAIR JOINTS (DETAILS 3 & 3A), THE JOINT TYPES SELECTED SHOULD PROVIDE FOR NO MORE EXPANSION SPACE THAN 4" IN 900' FOR PAVEMENTS WITH 99' JOINT SPACING, OR 2" IN 900' FOR PAVEMENTS WITH 72' JOINT SPACING AND NEOPRENE SEALS.

WHEN THERE ARE NO REPAIR LOCATIONS WITHIN A 900' LENGTH, NO EXPANSION SPACE WILL BE PROVIDED.

EQUAL EXPANSION SPACE SHOULD BE PROVIDED IN ADJACENT LANES. NO EXPANSION SPACE SHALL BE PROVIDED IN REPAIRS WHICH DO NOT EXTEND ACROSS ALL LANES.

TRANSVERSE CONTRACTION JOINTS TYPE "C" AND C₁ JOINT GROOVES (DETAIL 3 & 3A) SHALL BE SANDBLASTED FOLLOWED BY A FINAL CLEANING WITH OIL-FREE COMPRESSED AIR PRIOR TO SEALING WITH HOT-POURED RUBBER-ASPHALT JOINT SEALER. A BOND BREAKER (ALSO SHOWN IN DETAILS 3 & 3A) SHALL CONSIST OF A PRESSURE-SENSITIVE SILICONE-BACKED TAPE OR AN EQUIVALENT APPROVED BY THE ENGINEER.

THE PAVEMENT REINFORCEMENT SHALL BE PLACED 3" BELOW FINISHED SURFACE IN UNDOWELED REPAIRS OR AS SHOWN IN DETAIL 3A FOR DOWELED REPAIRS.

WHEN UNDOWELED REPAIRS ARE MADE IN JOINTED PAVEMENT, STANDARD PAVEMENT REINFORCEMENT SHALL BE USED TO REINFORCE CONCRETE REPAIRS 10' OR LONGER.

FOR ALL REPAIRS, EXPANSION SPACE SHOULD BE DISTRIBUTED THROUGHOUT THE SECTION RATHER THAN INSTALLING IT ALL AT ONE LOCATION. TO ALLOW FOR DISTRIBUTION OF PAVEMENT EXPANSION, REPAIRS MAY HAVE A CONTRACTION JOINT ON ONE END AND AN EXPANSION JOINT ON THE OTHER END. THE TYPE "A" JOINT SHOULD NOT BE USED IN REPAIRS OF NEOPRENE SEALED PAVEMENTS.

WHEN TRANSVERSE EXPANSION JOINTS ARE PLACED ADJACENT TO CONCRETE CURB AND GUTTER AND WHERE REMOVAL OF CURB AND GUTTER IS NOT NECESSARY AS DETERMINED BY THE ENGINEER, AN EQUIVALENT WIDTH OF EXPANSION JOINT Esc SHALL BE EXTENDED THRU THE CURB AND GUTTER.

TRANSVERSE JOINTS (DETAIL 4 AND 4A) SHALL BE SEALED IN ACCORDANCE WITH STANDARD PLAN II-39 SERIES.

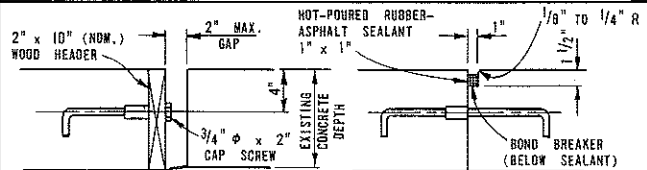

STEP 1

STEP 2

Section A-A

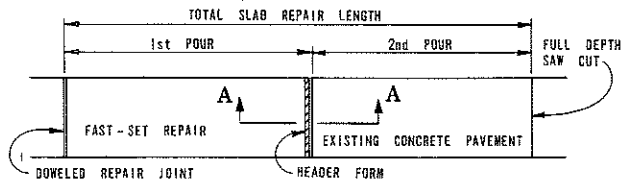

Plan View of Repair

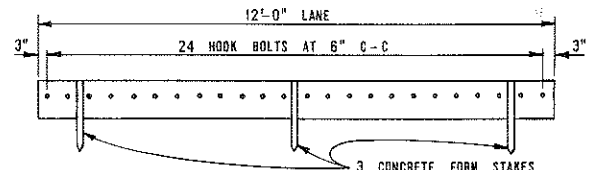

Spacing Layout for Hook Bolts

NOTE: REFER TO STANDARD PLAN II-39 SERIES FOR HOOK BOLT DETAIL.

OVERNIGHT CONSTRUCTION JOINT IN FAST-SET REPAIR

DETAIL 12

NOTES: (CONTINUED)

SAWS OVERCUTS OCCURRING IN ADJACENT SLAB, GUTTER, OR SHOULDER, WHICH WILL REMAIN IN PLACE, SHALL BE SEALED.

THE MONTH AND YEAR OF CASTING AND STATION NUMBER (IF REMOVED) SHALL BE STENCILED ON EACH CONCRETE REPAIR.

 PREPARED BY DESIGN DIVISION	ENGINEER OF CONSTRUCTION	ENGINEER - ROAD DESIGN
	ENGINEER OF MAINTENANCE	ENGINEER OF DESIGN
	ENGINEER OF TESTING AND RESEARCH	DEPARTMENT DIRECTOR JAMES P. FITZ
	DRAWN BY: H.A.W.	BY:
CHECKED BY: V.R.	ENGINEER OF TRAFFIC AND SAFETY	DEPUTY DIR

MICHIGAN DEPARTMENT OF TRANSPORTATION BUREAU OF HIGHWAYS STANDARD PLAN FOR CONCRETE PAVEMENT REPAIR			
APPROVAL	11-22-83 PLAN DATE	II-44F	SHEET 4 OF 4