

TE
228
.83
1972
c.2

FIELD EVALUATION OF A FLEXIBLE
TRAFFIC GUIDE POST

TSD-TR-154-72

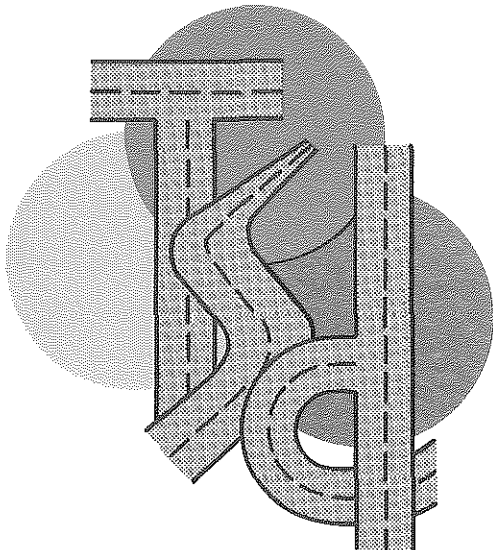

**TRAFFIC and
SAFETY
DIVISION**

LIBRARY
michigan department of
state highways
LANSING

**DEPARTMENT OF STATE HIGHWAYS
STATE OF MICHIGAN**

~~65-9355~~

65-9355

MICHIGAN STATE HIGHWAY COMMISSION

Charles H. Hewitt. Chairman
E. V. Erickson Vice Chairman
Claude J. Tobin. Member
Peter B. Fletcher. Member

FIELD EVALUATION OF A FLEXIBLE
TRAFFIC GUIDE POST

TSD-TR-154-72

LIBRARY
michigan department of
state highways
LANSING

By

Herbert R. Schoepke

MICHIGAN DEPARTMENT OF STATE HIGHWAYS

J. P. Woodford. Deputy Director - Chief Engineer
G. J. McCarthy. Asst. Deputy Director for Engineering
and Operations
J. G. Hautala Chief, Bureau of Operations
H. H. Cooper. Engineer of Traffic and Safety
P. H. DeCamp. Traffic Research and Development
Engineer
R. E. Addy. Supervising Engineer, Research
Studies Unit
Herbert R. Schoepke Study Technician

Department of State Highways
State Highways Building-P. O. Drawer K
Lansing, Michigan 48904

October 1972

STUDY CONDUCTED BY

Traffic Research and Development Section
Traffic and Safety Division
Michigan Department of State Highways

TABLE OF CONTENTS

	Page
INTRODUCTION	1
RESULTS AND RECOMMENDATIONS.	2
THE DEVICE	3
Figure 1 - Traf-Flex Post	4
LOCATION	5
Figure 2 - I-94 At Livernois Exit Ramps, City of Detroit.	6
Figure 3 - BL-94 At Lake St. City of Kalamazoo.	7
Figure 4 - M-43 (W. Main) at Douglas Avenue., City of Kalamazoo	8
METHOD OF EVALUATION	5
Figure 5 - Deceleration Lane & Lane Placement Reflective Markings.	10
Figure 6 - Distance From Post Vehicle Entered Deceleration Lane - Cars Only.	13
Figure 7 - Distance From Post Vehicle Entered Deceleration Lane - Trucks Only.	14
Figure 8 - Distance From Post Vehicle Entered Deceleration Lane - All Vehicles	15
Figure 9 - Distance From Delineator Posts - Cars.	16
Figure 10- Distance From Delineator Posts - Cars.	17
Figure 11- Distance From Delineator Posts - All Vehicles	18
Figure 12- Distance From Curb Face-Cars	20
Figure 13- Distance From Curb Face-Trucks	21
Figure 14- Distance From Curb Face-All Vehicles	22
Figure 15- Vehicle Contact Point With 26" And 36" Posts.	27
APPENDIX	34

INTRODUCTION

Continuing our effort to provide the motorist with a safer highway system, the Department of State Highways, in May of 1969, began this evaluation of "Safety Guide Delineator Posts". The study objective was to test the Traf-Flex Posts ability to provide adequate delination for the motorists, and to withstand damage by an errant vehicle by returning to its original position after impact. This type of delineation would be a valuable tool to traffic engineers in that it could be installed in close proximity to the roadway without creating a hazard to the motoring public. The plan was to sample the effectiveness of the post in situations representing various combinations of traffic conditions that might be present in actual usage were it successful. These include urban freeway, divided suburban with access control and one-way urban turn.

RESULTS

The driver behavior data indicated this device does improve roadway delineation in the area used. The drivers made more use of the deceleration lane and the lane placement changes were acceptable.

The observation data at the high speed location (45-55 m.p.h.) showed the first set of posts made of Cyclocac plastic would not withstand impact after exposure to cold weather. The second set of posts made of cross link polyethylene plastic at the high speed location gave acceptable performance during weather exposure. At this location shock cord failure was experienced with both sets of posts along with some epoxy failure, especially during the second year. At the low speed locations (25-40 m.p.h.), the experience with the Cyclocac post was much better as only three units were lost in cold weather.

RECOMMENDATIONS

This device should be available for use at locations where other devices for delineation are difficult to maintain and the speeds are 40 m.p.h. or less.

The device may also be warranted at locations where the speed exceeds 40 m.p.h. but where, in spite of cost for replacement, they would serve an important safety purpose.

The manufacturer should be encouraged to improve the shock cord

strength of the device and to investigate other methods of anchoring. If these improvements are made the device should be re-evaluated, particularly under high speed conditions.

THE DEVICE

The 2.375 inch outside Diameter post (Figure 1) comes in two lengths, 23-17/32 inches and 33-17/32 inches. The base is 1-7/8 inch thick by 7 inches in diameter. The shock cord in the hinge assembly is constructed of thin strips of rubber bound by a double strand nylon cotton cover.

Two posts of different materials were tested. The material used in the first post, base and hinge assembly is Cycolac brand (acrylonitrile, butadine, styrene) plastic. This is the type of plastic used in football helmets, timber wedges, etc. The material in the second post is (cross link polyethylene) plastic with advertised properties of improved ability to withstand impact, weight and cold weather exposure. The posts were installed for this test on hard surfaces of bituminous or concrete by spreading the manufacturers recommended epoxy and pressing on the post base.

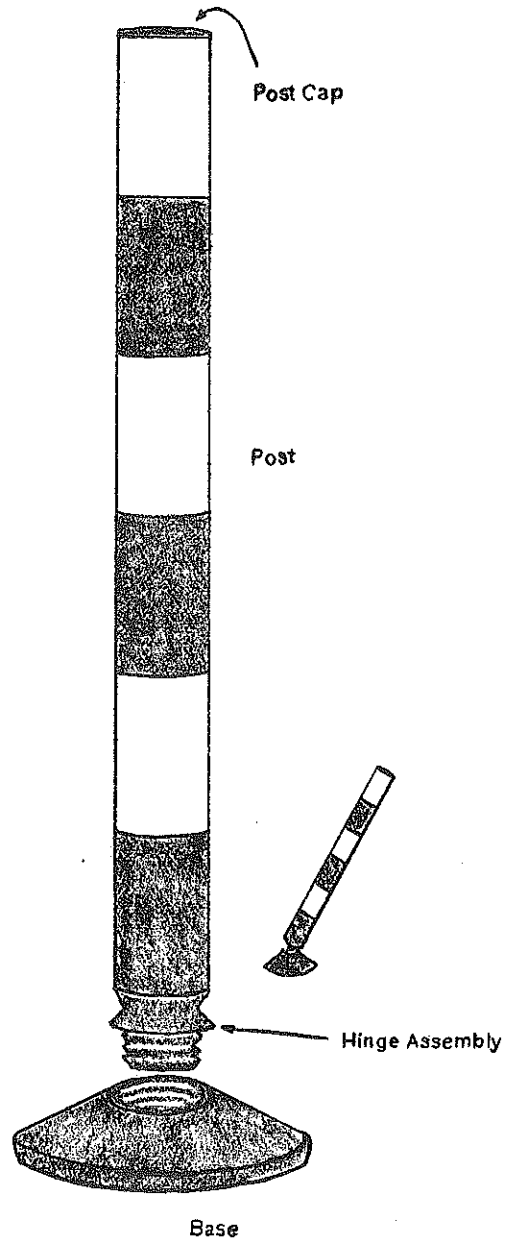

Safety Guide[®] Traf-Flex Post

Figure 1

LOCATION

Three locations were chosen for test installation as follows:

1. I-94 (Edsel Ford) at exit ramps to Livernois Avenue in the City of Detroit. These exit ramps have long narrow gore areas, which on a high volume, high speed urban freeway are difficult to delineate. A schematic of this location is shown in Figure 2.
2. BL-94 at Lake Street in the City of Kalamazoo. This low speed location has two curbed islands which provide protected left turn lanes. Due to the necessary alignment change to construct the islands adequate delineation is difficult. A schematic of this location is shown in Figure 3.
3. M-43 (West Main Street) at Douglas Avenue in the City of Kalamazoo. This low speed location is a T intersection with two legs being one way only. It requires the left turning traffic to negotiate a sharp left turn with a narrow curbed median. A schematic of this location is shown in Figure 4.

The locations selected provided a cross section of location types where the device could provide a traffic benefit and be evaluated at the same time.

METHOD OF EVALUATION

1. Driver behavior

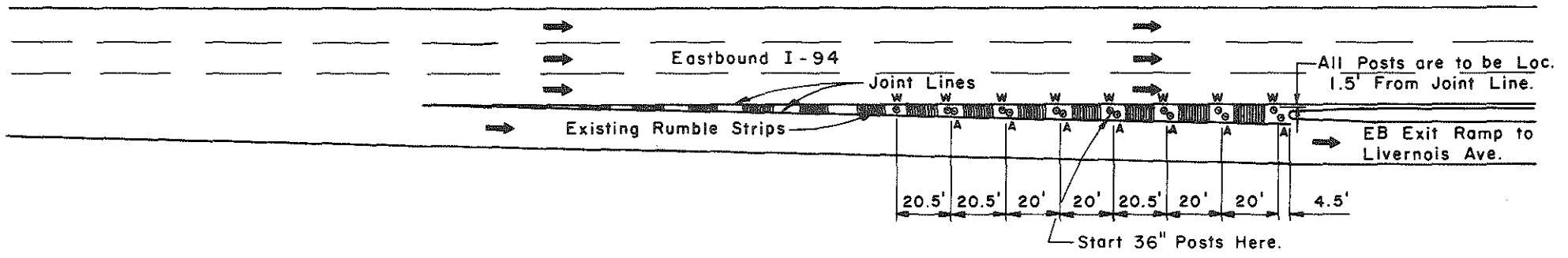

Eastbound I-94 At Livernois Ave. Exit Ramp Showing Reflectorized Guide Post Installation.

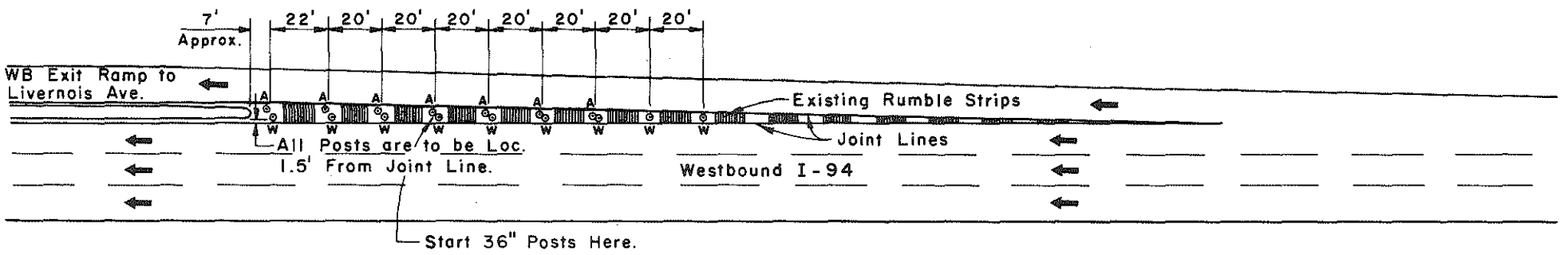

Westbound I-94 At Livernois Ave. Exit Ramp Showing Reflectorized Guide Post Installation.

W = White Posts on Freeway Side.
 A = Amber Posts on Ramp Side.

Figure 2 - REFLECTORIZED GUIDE POST INSTALLATIONS ON EB & WB I-94 AT LIVERNOIS AVE. EXIT RAMPS.



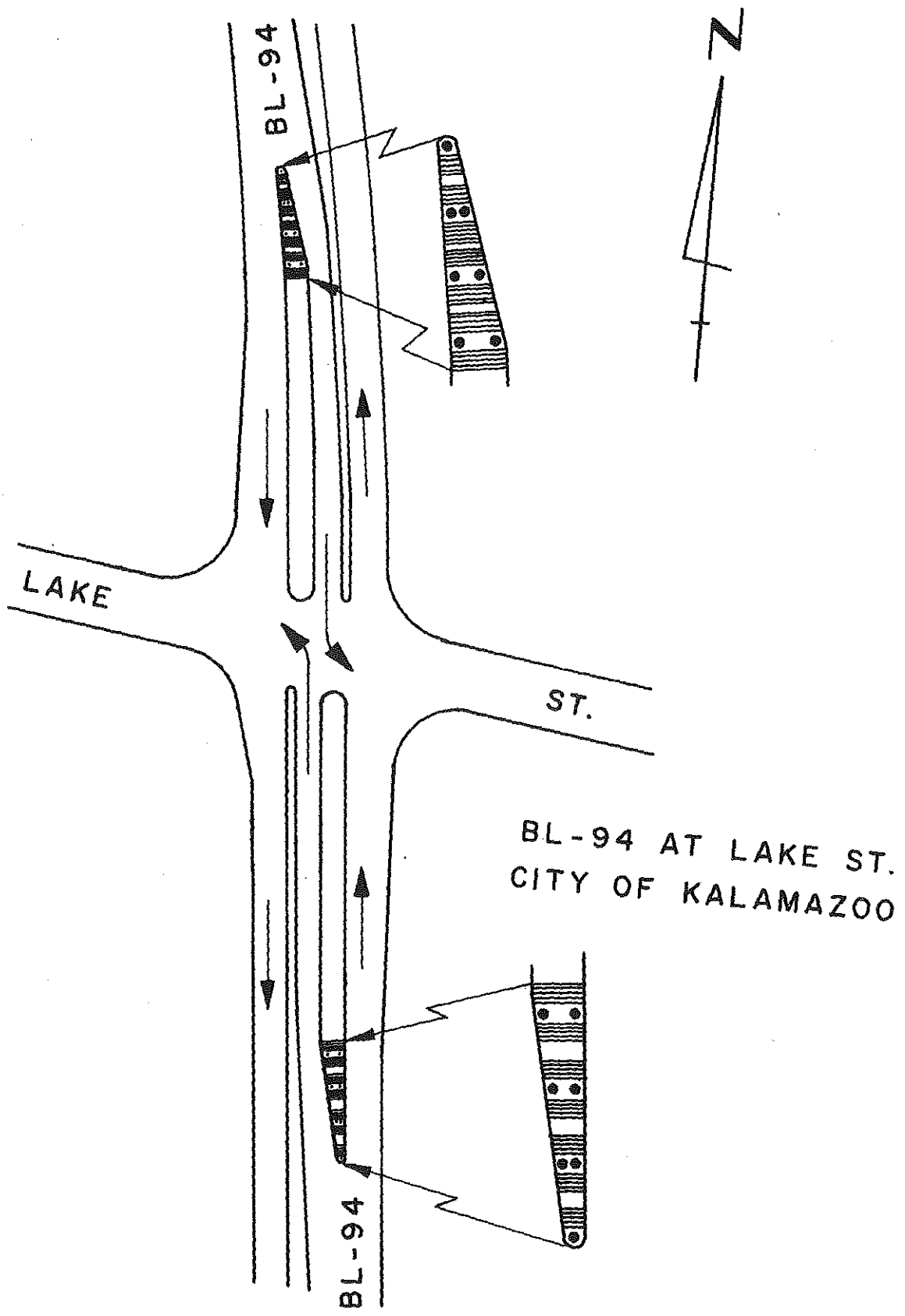

BL-94 AT LAKE ST.
CITY OF KALAMAZOO

FIGURE 3
-7-

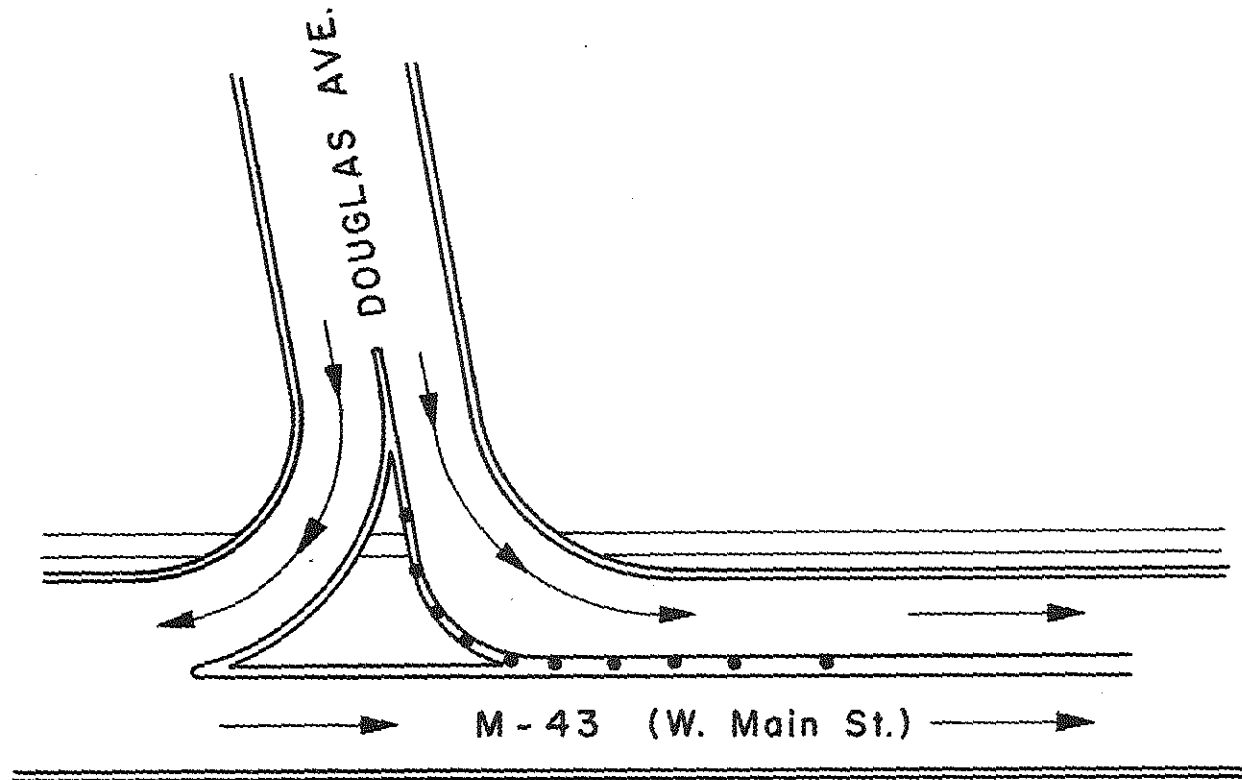

M-43 (W. Main St.) AT DOUGLAS AVE.
CITY OF KALAMAZOO

FIGURE 4

2. Visual inspection for durability and operation of the device.

Driver behavior data was obtained at west bound I-94 and Livernois Avenue exit ramp. Two consecutive days were used to eliminate any variance in weather and types of drivers. Reference marks were placed on the curb and gutter area of the ramp deceleration lane. At two locations reference marks were placed at one foot intervals to obtain lane placement. A diagram of the reference mark layout is shown in figure 5.

LIBRARY
michigan department of
state highways
LANSING



- 01 -

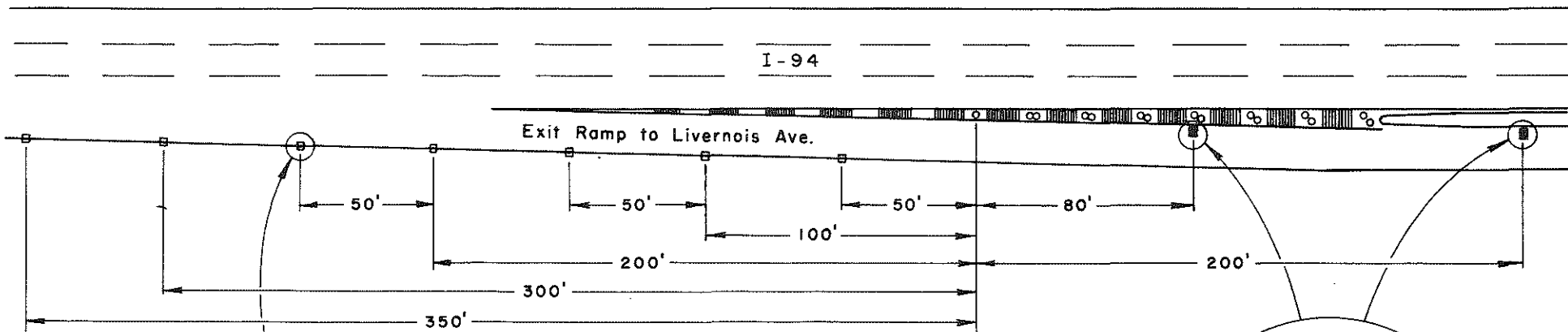

Pavement Reference Markings Used At Reflectorized Guide Post Installations On EB & WB I-94 At Livernois Ave. Exit Ramps.- Locate As Shown.

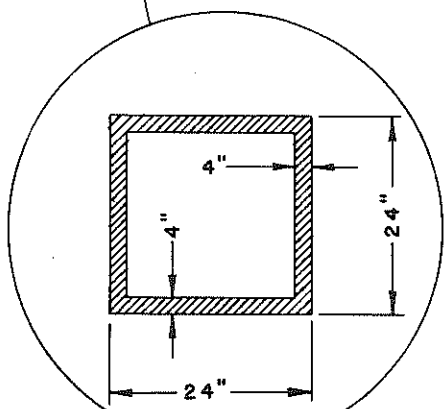

Enlarged View Of Pavement Ref. Markings Used For Cars Entering Deceleration Lane.

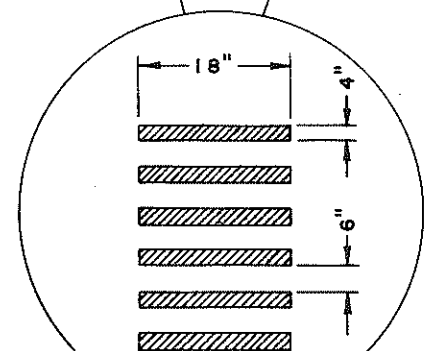

Enlarged View Of Pavement Ref. Markings Used For Lane Placement Of Vehicles.

Figure 5 - DECELERATION LANE & LANE PLACEMENT REFERENCE MARKINGS.
- LIVERNOIS AVE. EXIT RAMPS AT EB & WB I-94. -

Method of Evaluation - Cont.

Motion pictures were taken of vehicles using the exit during the same time period on two successive days. Five one-hundred foot rolls of film were exposed for both the before and after condition. Each consecutive vehicle using the ramp was sampled, missing only the vehicles that passed during required film changes. As many samples as possible were taken under each condition with a minimum of 100 samples. The film was then analyzed by viewing with a time lapse projector and using the reference marks to plot the vehicle path.

The first set of reference marks provides a comparison of the drivers use of the deceleration lane. Figures 6, 7, and 8 show this comparison for passenger cars, trucks, and all vehicles.

The data in these figures show the drivers increased their use of the deceleration lane. A statistical analysis of this data proved this to be a significant increase at 95% confidence level (see statistical analysis in Appendix). Due to this increase in use of the deceleration lane it is concluded that delineation of the ramp gore was improved with the installation of the posts.

The second set of reference marks provides a comparison of lane placement of the vehicle. Its proximity to the installed posts was observed in the after period and to a rumble strip in the before period. Figures 9, 10, and 11 show this comparison for passenger cars, trucks and all vehicles.

The data in these figures showed that the installation of the

posts moved the driver approximately six inches to the right. A statistical analysis proved this to be a significant change at 95% confidence level (see statistical analysis in Appendix). With the drivers making more use of the deceleration lane and the posts being more of a physical barrier than the rumble strip close to the traveled roadway, this change is expected and reasonable.

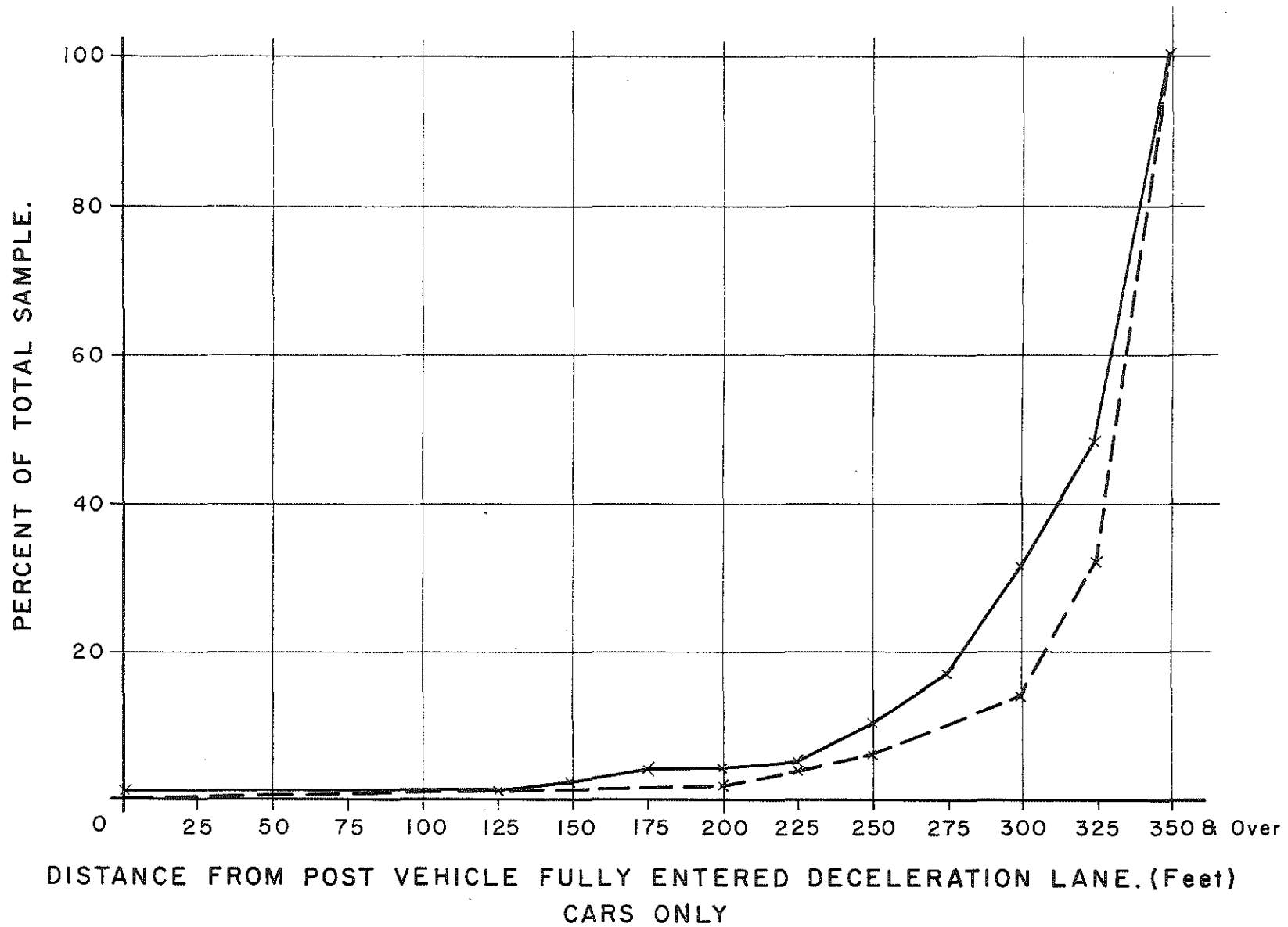

Before Traf-flex Post Installation ——— ×
 After Traf-flex Post Installation - - - - ×

Figure 6

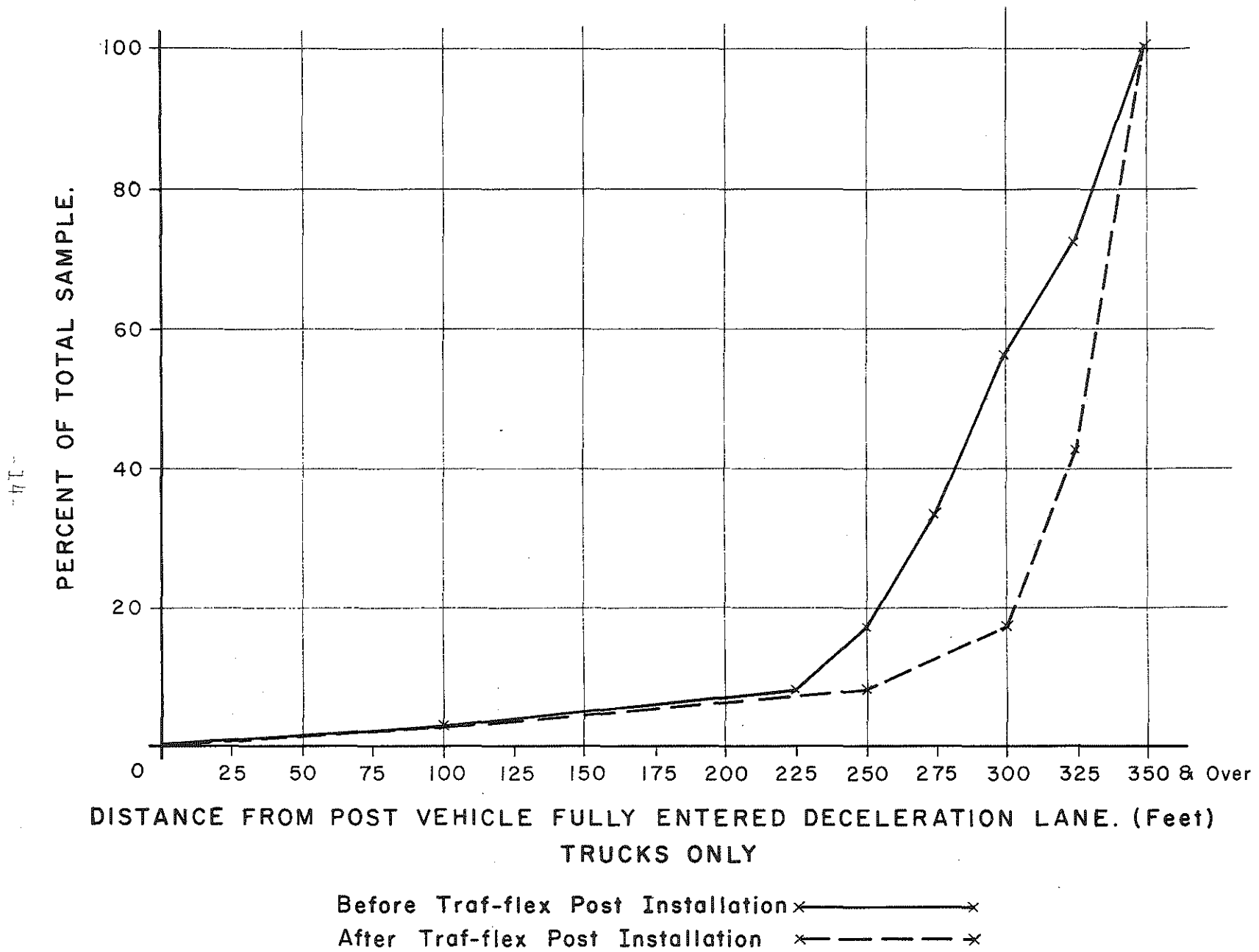

Figure 7

15

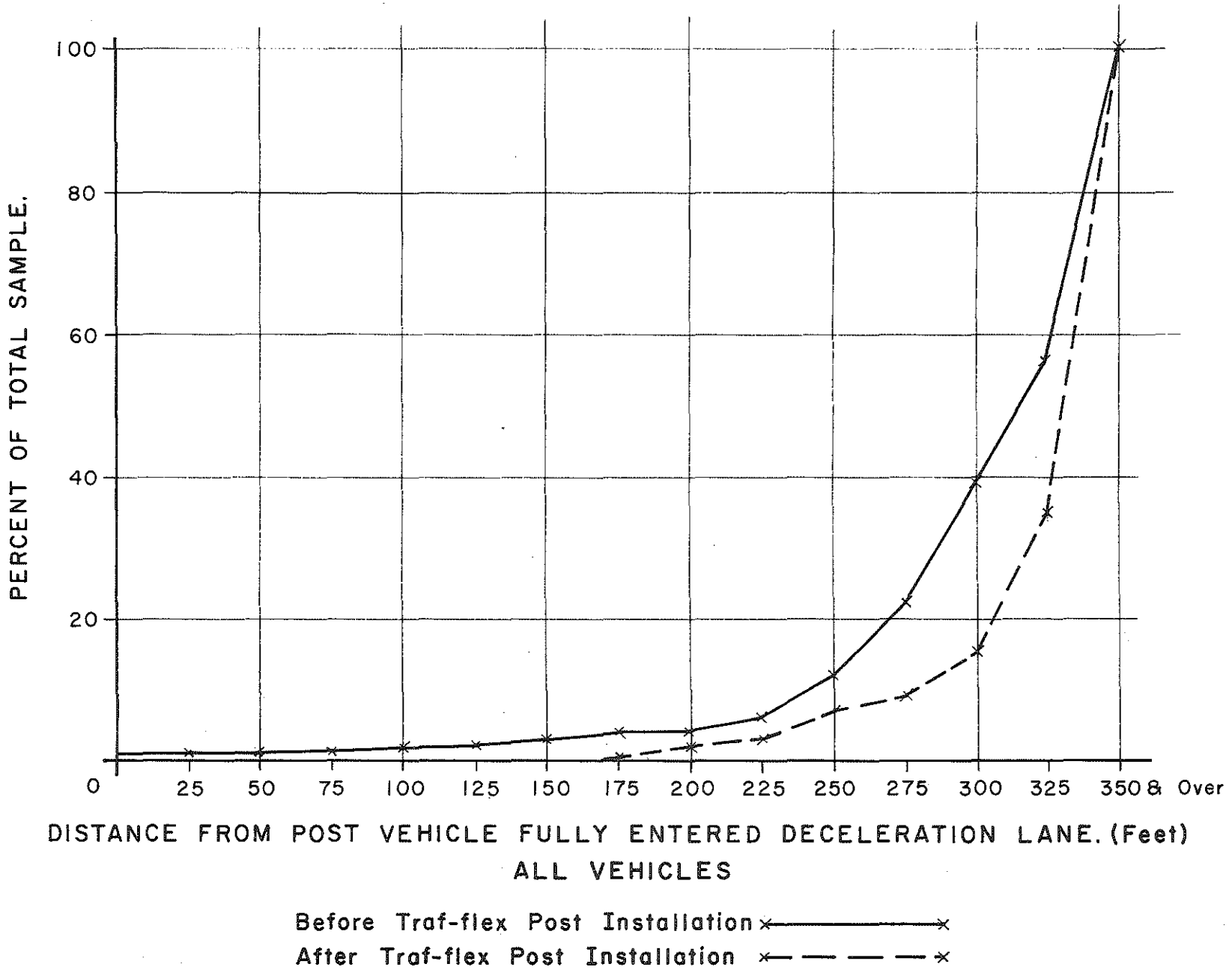

Figure 8

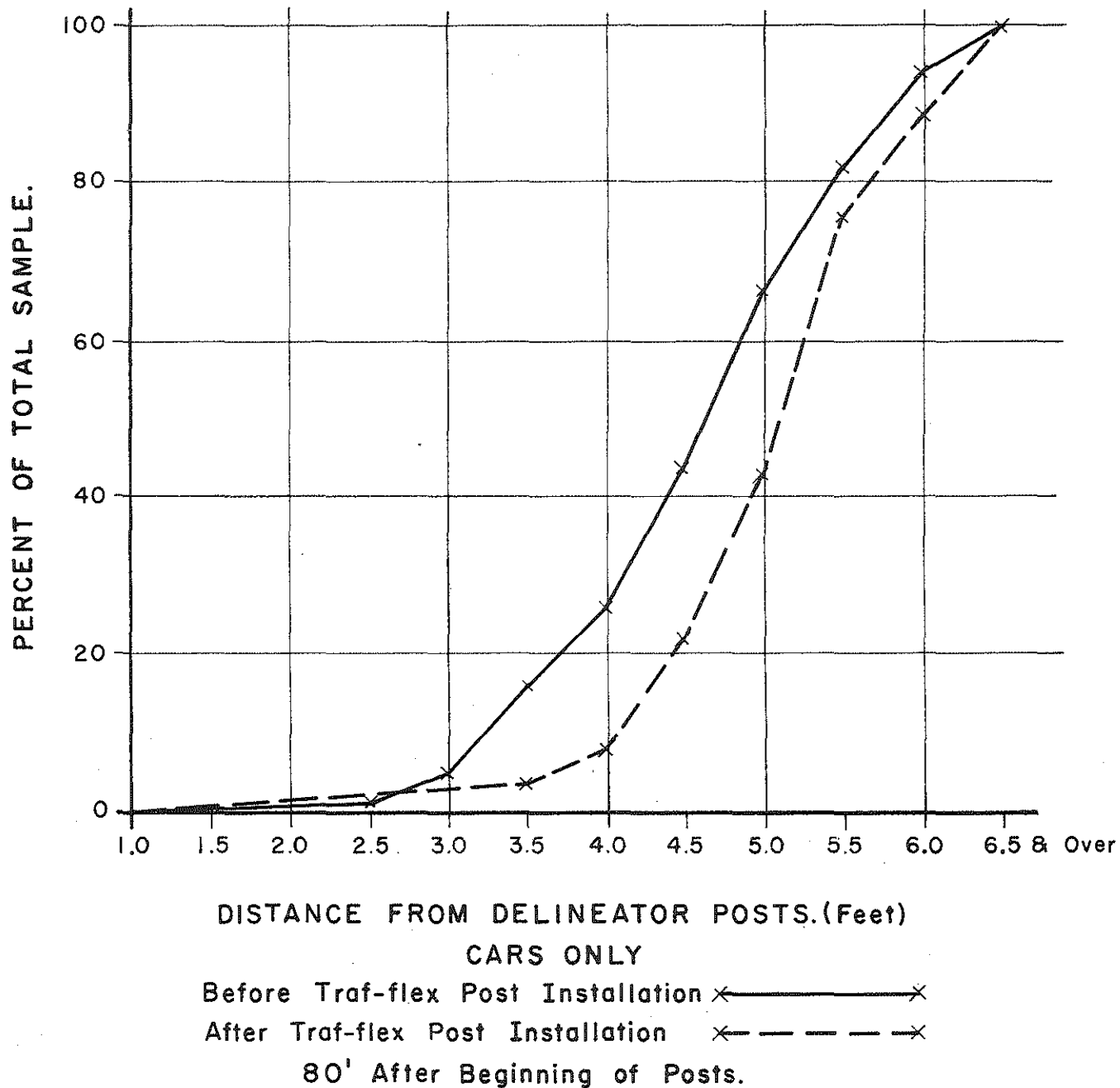
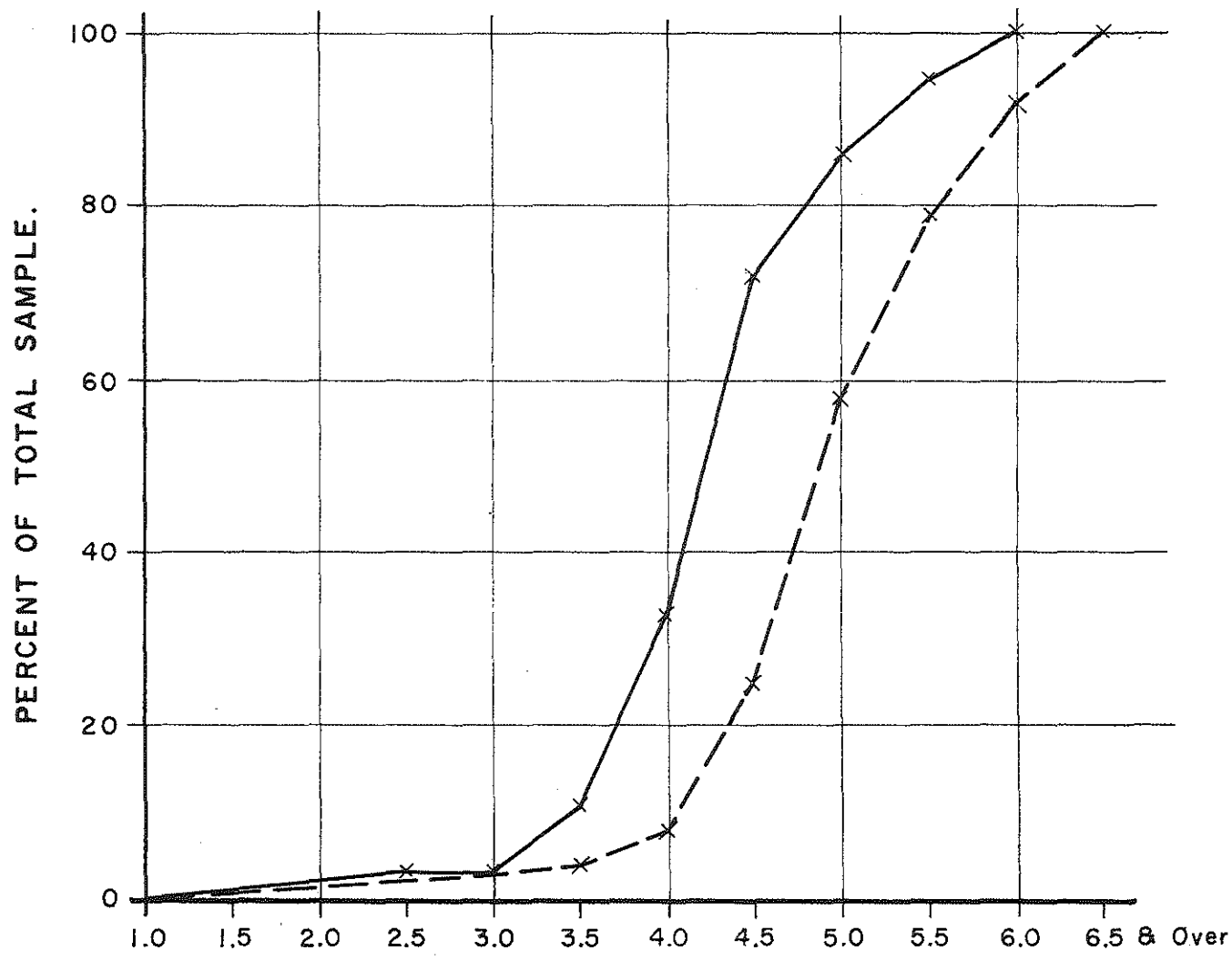

Figure 9



DISTANCE FROM DELINEATOR POSTS.(Feet)
 TRUCKS ONLY
 Before Traf-flex Post Installation ×————×
 After Traf-flex Post Installation ×———×
 80' After Beginning of Posts.

Figure 10

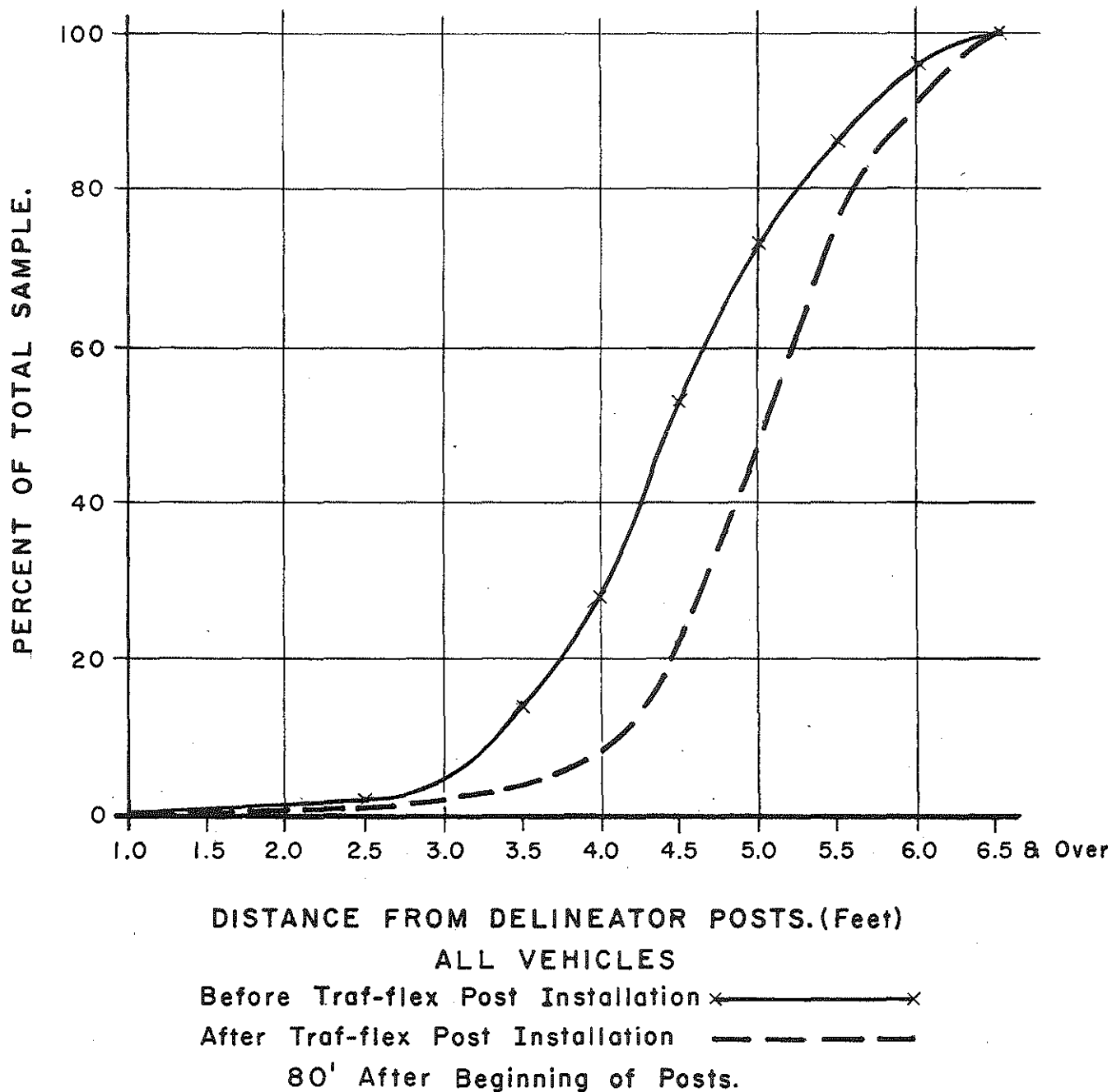
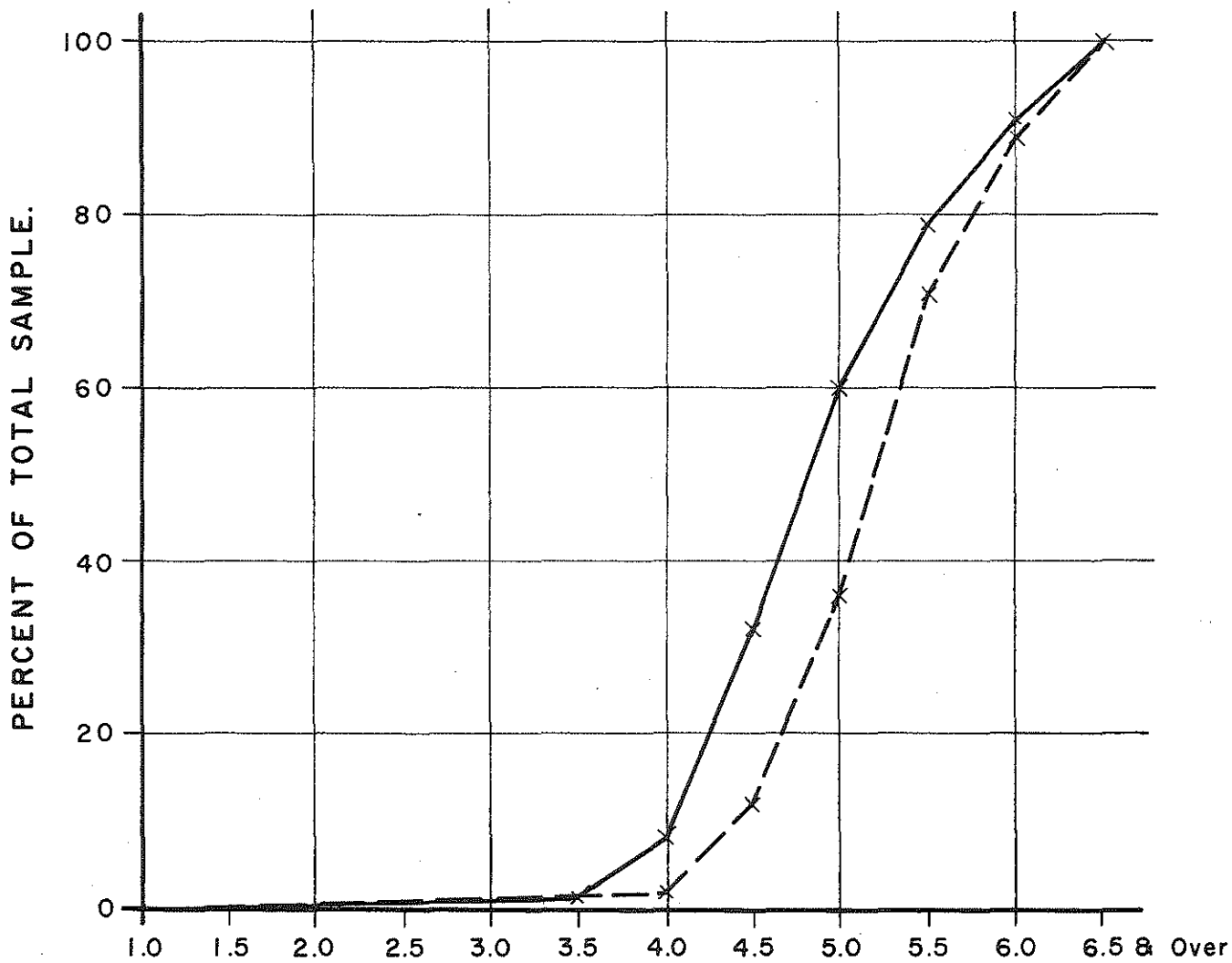

Figure 11

The third set of reference marks provides a comparison of lane placement at the curb face of the island separation. Figures 12, 13, and 14 show this comparison for passenger cars, trucks and all vehicles.

The data in these figures show the lane placement of a typical vehicle had moved to the right four inches. A statistical analysis proved this to be a significant change at 95% confidence level (see statistical analysis in Appendix). From this data it appears the driver was quickly moving back to his normal lane placement position as he neared the end of the post installation.



DISTANCE FROM CURB FACE. (Feet)
 CARS ONLY
 Before Traf-flex Post Installation ×————×
 After Traf-flex Post Installation ×-----×
 200' After Beginning of Posts.

Figure 12

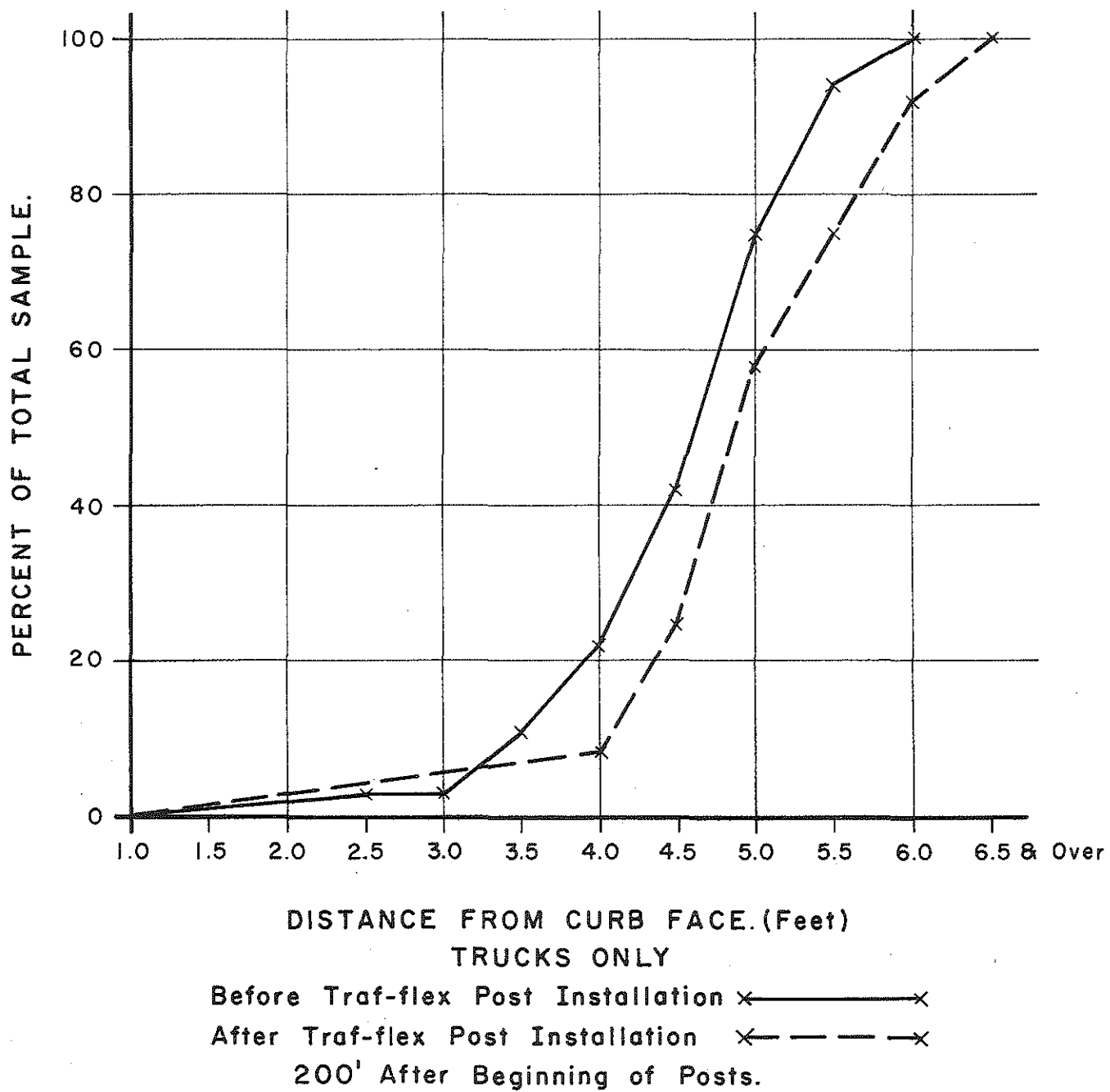

Figure 13

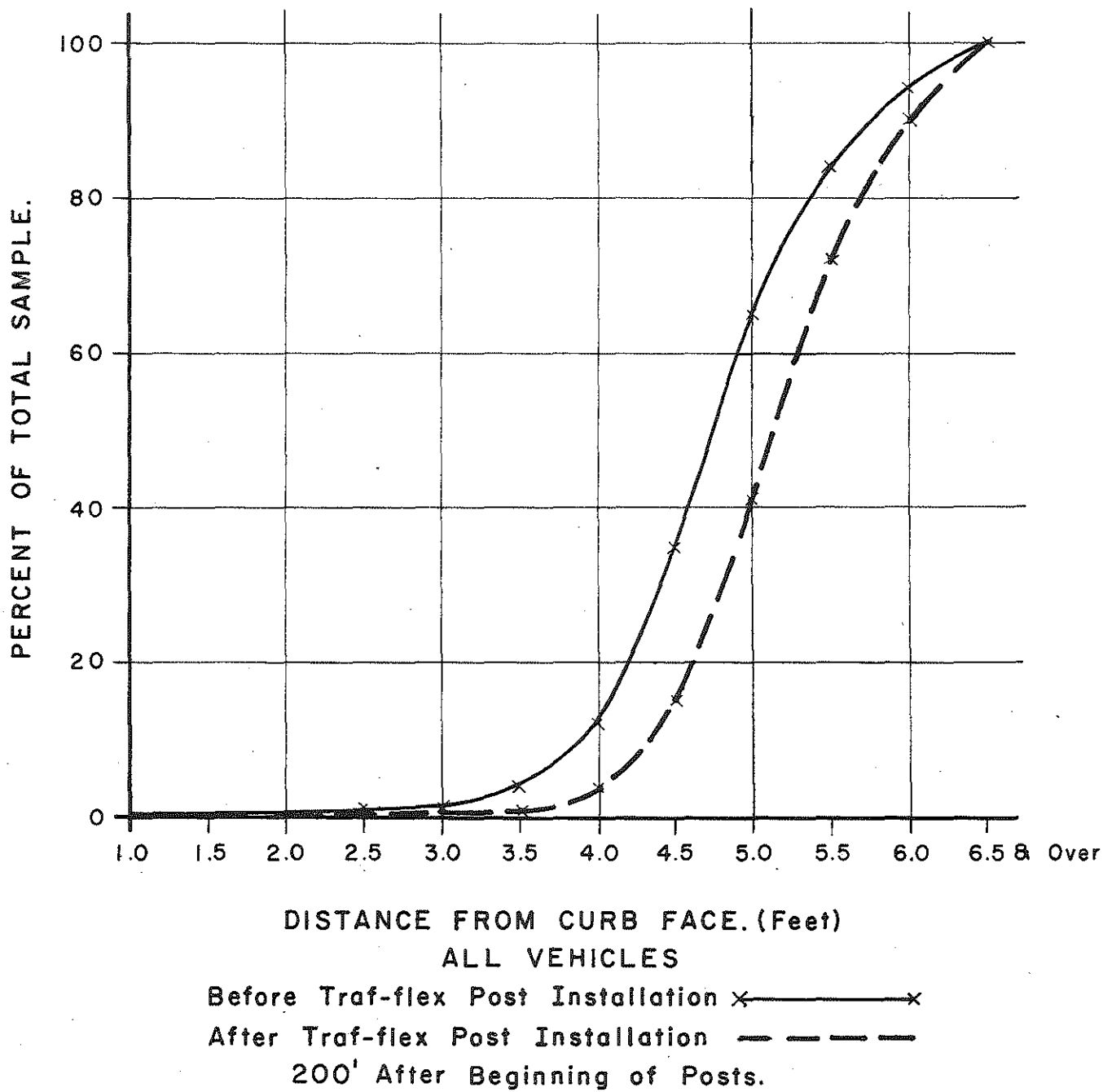

Figure 14



The visual inspection portion of the study was conducted by making periodic close inspections of the devices at each location. These inspections were scheduled at approximately three week intervals. The first two inspections of I-94 at Livernois Avenue showed the posts had been hit several times and had performed well. All posts were in an upright position with no apparent damage. The reflective sheeting which was applied to the posts showed some abrasion from being hit. (See photograph above)



During the latter part of October the installation in the East-bound direction of travel was struck by a vehicle at an excessive rate of speed. (See photograph above)

As can be seen from the above photograph, the 26" posts performed very well. Two of the 36" posts failed and were sheared off at the shock cord as shown in the following photographs.

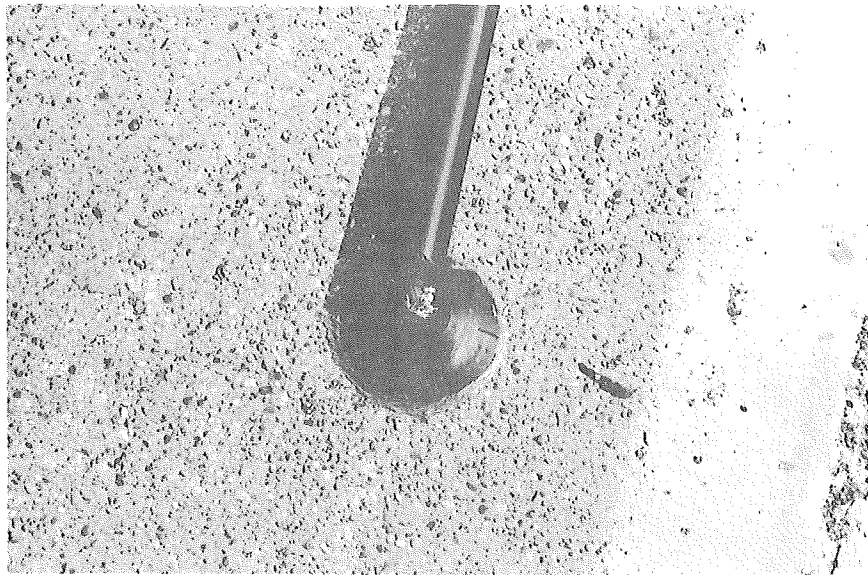
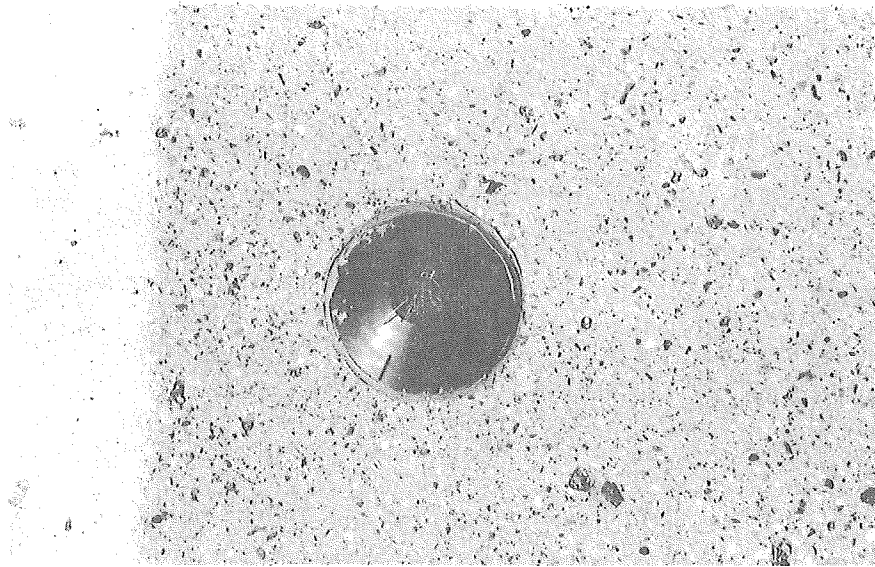

It is felt that the bumper of a vehicle makes contact at or just below the vertical center of mass of the 36" post, thereby exerting excessive sheer force on the shock cord, causing failure. (See Figure 15). By the latter part of December, with the beginning of winter and cold weather, shock cord failure was experienced in several of the units. The cord failure was more predominant in the 36" units. One case of epoxy failure was found. Almost all of the units had been hit once and many of them several times. One of the most important observations at this time was a cracking of plastic in the vertical direction on some of the units. This cracking has occurred to such a degree that the plastic cap was missing from three of the units. By the end of February all but a few of the units were broken or the shock cord had failed. Typical condition of the installation is shown in the following photographs.

LIBRARY
michigan department of
state highways
LANSING

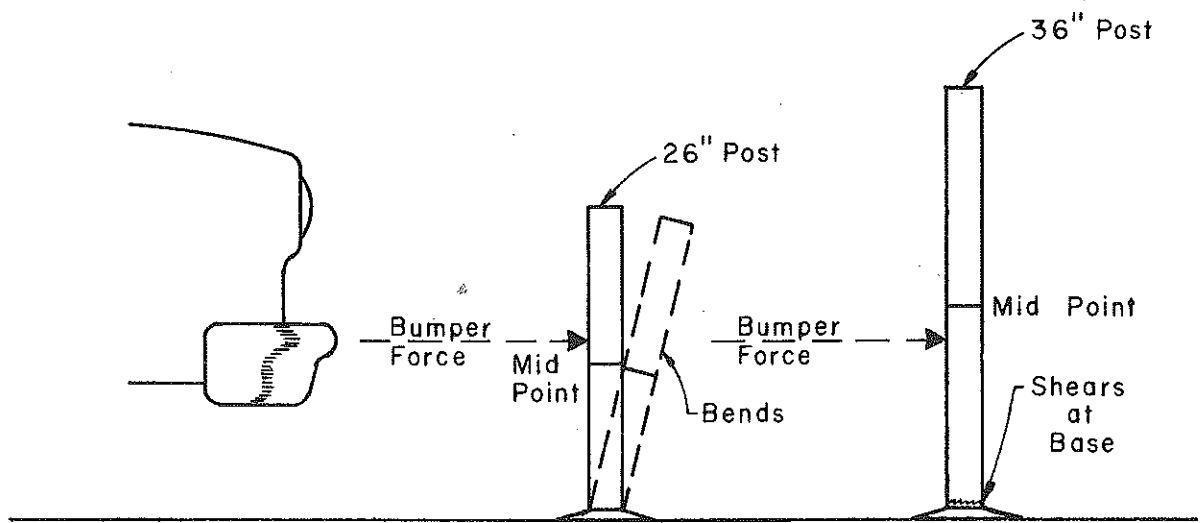

VEHICLE CONTACT POINT WITH 26" AND 36" POSTS

Figure 15

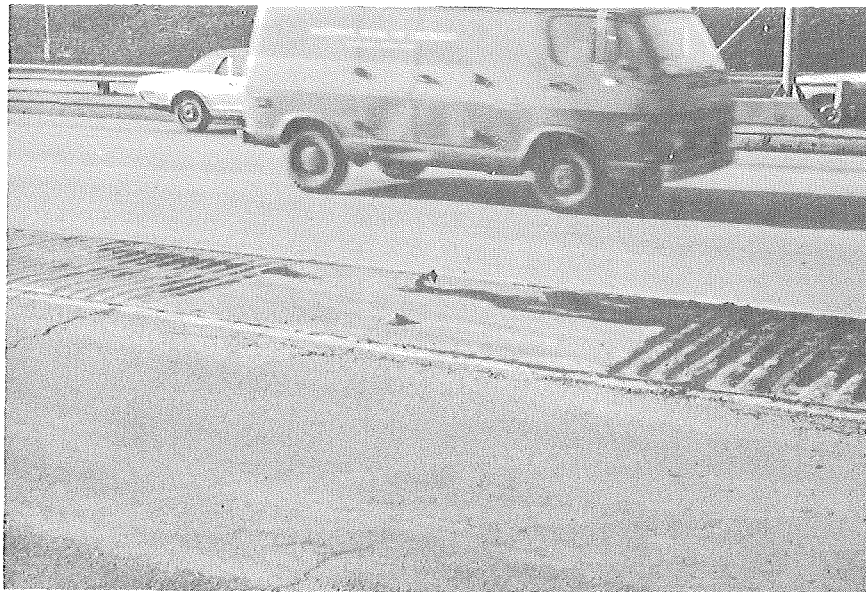

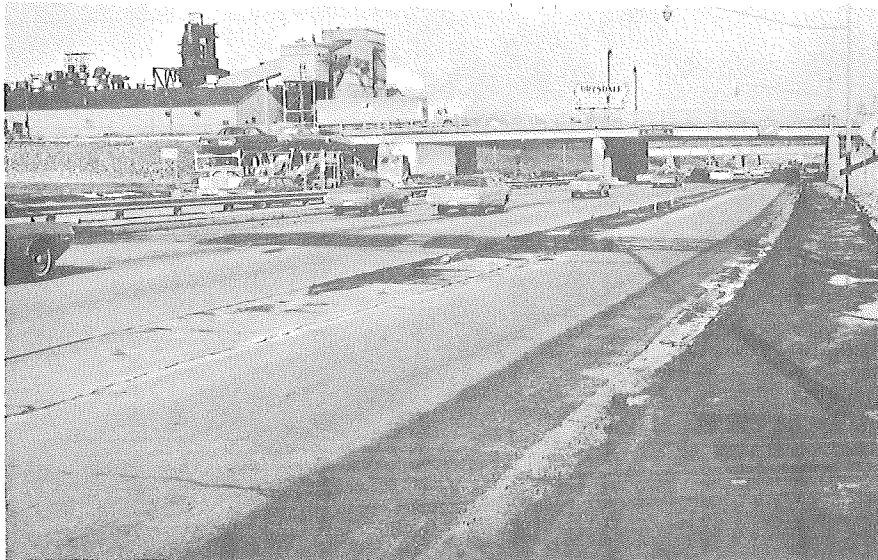

After viewing the I-94 at Livernois Avenue location and the condition of the posts, the manufacturer furnished a new set of posts. The new posts were made of a cross-linked polycarbonate type of plastic, the end caps were riveted in place and the shock cord had a heavy nylon cover. The new posts were installed on September 2, 1970.

An inspection was made on September 25, 1970. The installation had been hit at least once. One unit had an epoxy failure and one was slightly deformed but not broken. The next inspection was made on November 27, 1970. One unit was missing from shock cord failure, the rest were in good condition. On January 5, 1971 the next inspection was made. The installation in the westbound direction had been hit very severely. Six units were missing from epoxy failure and five units were missing from shock cord failure. Some of the missing posts were found but no cracking of the plastic was evident even though they had been run over several times. (See following photographs)



In the eastbound direction, three units were missing; two due to epoxy failure, and one due to shock cord failure.

The two locations in the City of Kalamazoo were in low speed traffic areas. In February 1971, a close inspection was made of both locations. The condition of units at the B.L. I-94 at Lake Street location was excellent for two years service. One unit was broken as shown in the following photographs.



The M-43 (West Main) at Douglas Avenue has only one unit still standing. A close investigation showed over half of the missing units were due to epoxy failure. This location is in close proximity to Western Michigan University and some of the missing units show signs of vandalism. Photographs of location follow.

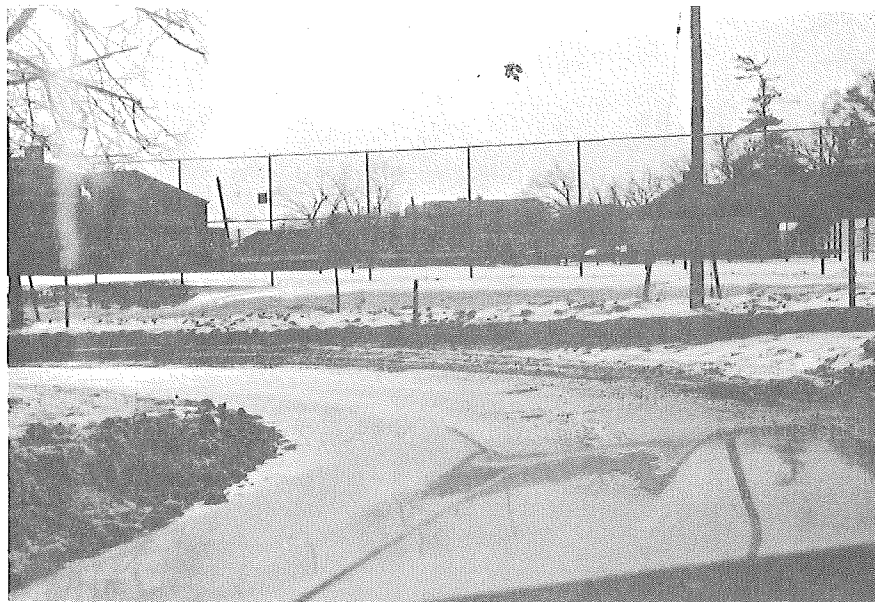

APPENDIX

STATISTICAL ANALYSIS

I. THEORY

It is desired to test the hypothesis that the means of two normal populations are equal, given independent samples from the two populations and assuming that the population variances are equal.

Model:

$$X_{ij} = \mu_i + \epsilon_{ij} \quad \text{with } i = 1, 2 \quad \text{and } j = 1, 2, \dots, n_i$$

Where ϵ_{ij} are independent chance components with identical normal distributions $N(0, \sigma)$.

Hypotheses:

Null Hypothesis: $\mu_1 = \mu_2$

Alternative Hypothesis: $\mu_1 < \mu_2$

II. APPLICATION

1. To test the significant increase of length in using the deceleration lane due to installing of posts.

a. Passengers Cars

$$n_1 = 76$$

$$n_2 = 83$$

$$\bar{x}_1 = 321.71 \text{ ft.}$$

$$\bar{x}_2 = 332.8313 \text{ ft.}$$

$$s_1 = 41.2274$$

$$s_2 = 33.3671$$

$$t = 11.4960 > t_{.05, 159} = 1.645$$

Reject H_0

Significant increase of length in using the deceleration lane.

b. Trucks

$$\begin{aligned}n_1 &= 36 & n_2 &= 24 \\ \bar{x}_1 &= 300 & \bar{x}_2 &= 331.25 \\ s_1 &= 50.346 & s_2 &= 29.091 \\ t &= 18.3161 > t_{.05, 58}\end{aligned}$$

Reject H_0

Significant Increase

c. Total Vehicles

$$\begin{aligned}n_1 &= 112 & n_2 &= 107 \\ \bar{x}_1 &= 314.7321 & \bar{x}_2 &= 332.4766 \\ s_1 &= 45.5072 & s_2 &= 32.4640 \\ t &= 3.3180 > t_{.05, 217}\end{aligned}$$

Reject H_0

Significant Increase

All three tests indicated statistically significant increase of length in using the deceleration lane due to the installation of the posts at 95% confidence level.

2. To test the significant increase of lane placement of the driver next to the installed posts in the after period and a rumble strip in the before period at location A (80' beginning of posts).

a. Passenger Cars

$$\begin{aligned}n_1 &= 77 & n_2 &= 83 \\ \bar{x}_1 &= 4.8311 \text{ (ft.)} & \bar{x}_2 &= 5.2891 \\ s_1 &= 0.9452 & s_2 &= 0.7326 \\ t &= 3.3951\end{aligned}$$

Reject H_0

Significant Increase

b. Trucks

$$\begin{aligned}n_1 &= 36 & n_2 &= 24 \\ \bar{x}_1 &= 4.4861 & \bar{x}_2 &= 5.1667 \\ s_1 &= 0.7019 & s_2 &= 0.7167 \\ t &= 3.5721\end{aligned}$$

Reject H_0

Significant Increase

c. Total Vehicles

$$\begin{aligned}n_1 &= 113 & n_2 &= 107 \\ \bar{x}_1 &= 4.7212 & \bar{x}_2 &= 5.2616 \\ s_1 &= 0.8897 & s_2 &= 0.7309 \\ t &= 4.9351\end{aligned}$$

Reject H_0

Significant Increase

All three tests showed statistically significant increase in the offset distance of placement of the vehicle on the lane to the installed posts; compared with those next to a rumble strip at location A at 95% confidence level.

3. To test the significant increase of lane placement of the driver next to the installed posts in the after period and a rumble strip in the before period at location B (200' beginning of posts).

a. Passenger cars

$$\begin{aligned}n_1 &= 76 & n_2 &= 83 \\ \bar{x}_1 &= 5.1578 & \bar{x}_2 &= 5.4518 \\ s_1 &= 0.7034 & s_2 &= 0.5992 \\ t &= 2.2841\end{aligned}$$

Reject H_0

Significant Increase

b. Trucks

$$\begin{aligned}n_1 &= 36 & n_2 &= 24 \\ \bar{x}_1 &= 4.75 & \bar{x}_2 &= 5.2083 \\ s_1 &= 0.75 & s_2 &= 0.6906 \\ t &= 2.3932\end{aligned}$$

Reject H_0

Significant Increase

c. Total Vehicles

$$\begin{aligned}n_1 &= 113 & n_2 &= 107 \\ \bar{x}_1 &= 5.0176 & \bar{x}_2 &= 5.3925 \\ s_1 &= 0.7464 & s_2 &= 0.6303 \\ t &= 4.0442\end{aligned}$$

Reject H_0

Significant Increase

All three tests showed statistically significant increase in the offset distance of placement of the vehicle on the lane to the installed posts; compared with those next to a rumble strip at location B at 95% confidence level.