

**CENTER HINGE STAINLESS STEEL
DETAIL "A"**

NOT TO SCALE

File: RefDoc/TR/Signals/Web/Sp Det/Fin/SIG440A.dgn Rev: 02/16/17



PREPARED BY
TRAFFIC AND SAFETY

DRAWN BY: DCK

CHECKED BY:

ENGINEER OF DELIVERY

ENGINEER OF DEVELOPMENT

(SPECIAL DETAIL)

FHWA APPROVAL DATE

MICHIGAN DEPARTMENT OF TRANSPORTATION
BUREAU OF HIGHWAYS DELIVERY STANDARD PLAN FOR

MICROWAVE VEHICLE DETECTOR

PLAN DATE

SIG-440-A

SHEET
1 of 4

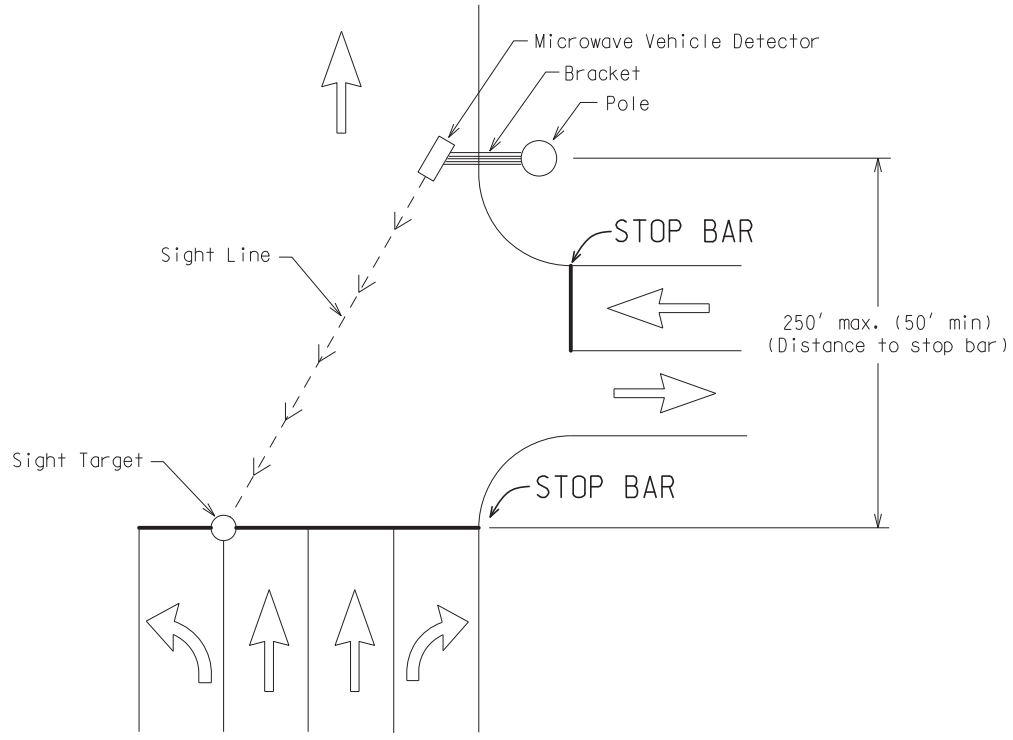

SIGHT ORIENTATION DIAGRAM

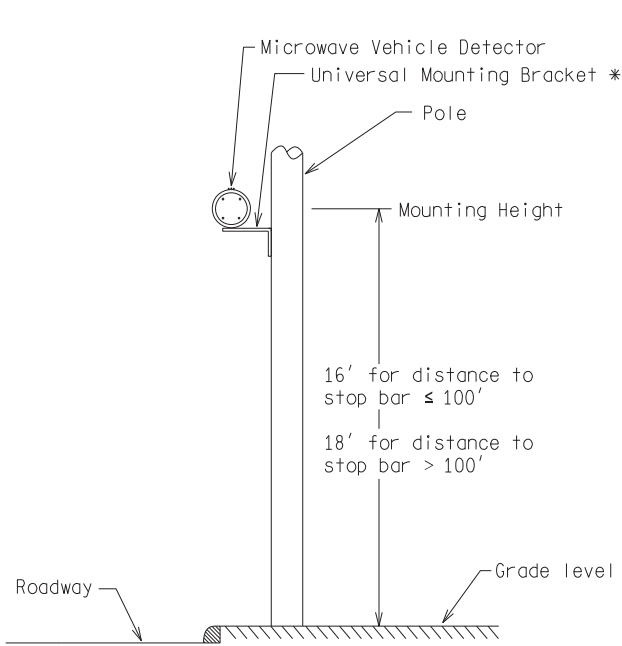

SIDE POLE MOUNTED

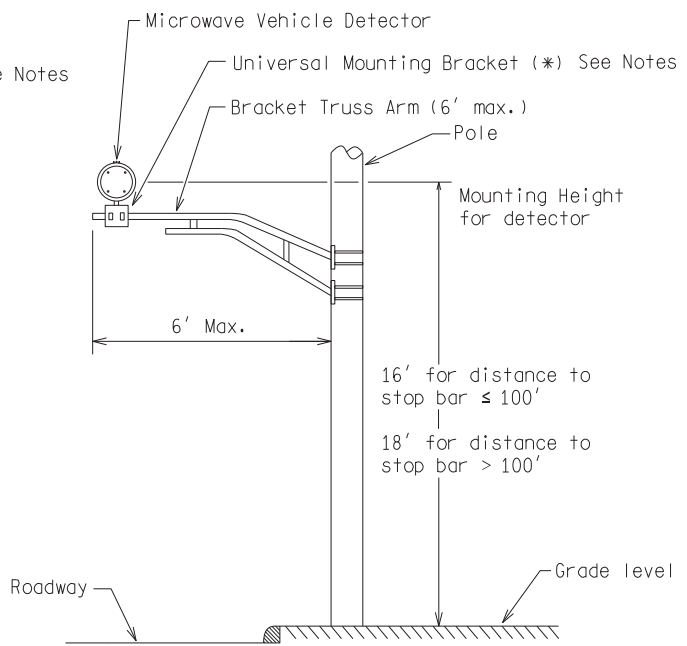

BRACKET TRUSS ARM MOUNTED

(*) Notes:

1. Use 3/8" x 5" Hex head screw (2" min.) for mounting to wood poles.
2. Use 3/4" x 0.30 min. stainless steel band for mounting to steel poles, pedestals or bracket truss arms.

NOT TO SCALE

MICHIGAN DEPARTMENT OF TRANSPORTATION BUREAU OF HIGHWAYS DELIVERY STANDARD PLAN	(SPECIAL DETAIL) FHWA APPROVAL DATE		SIG-440-A	SHEET 2 of 4
File: RefDoc/TR/Signals/Web/Sp Det/Fin/SIG440A.dgn	Rev. 02/16/17	PLAN DATE		

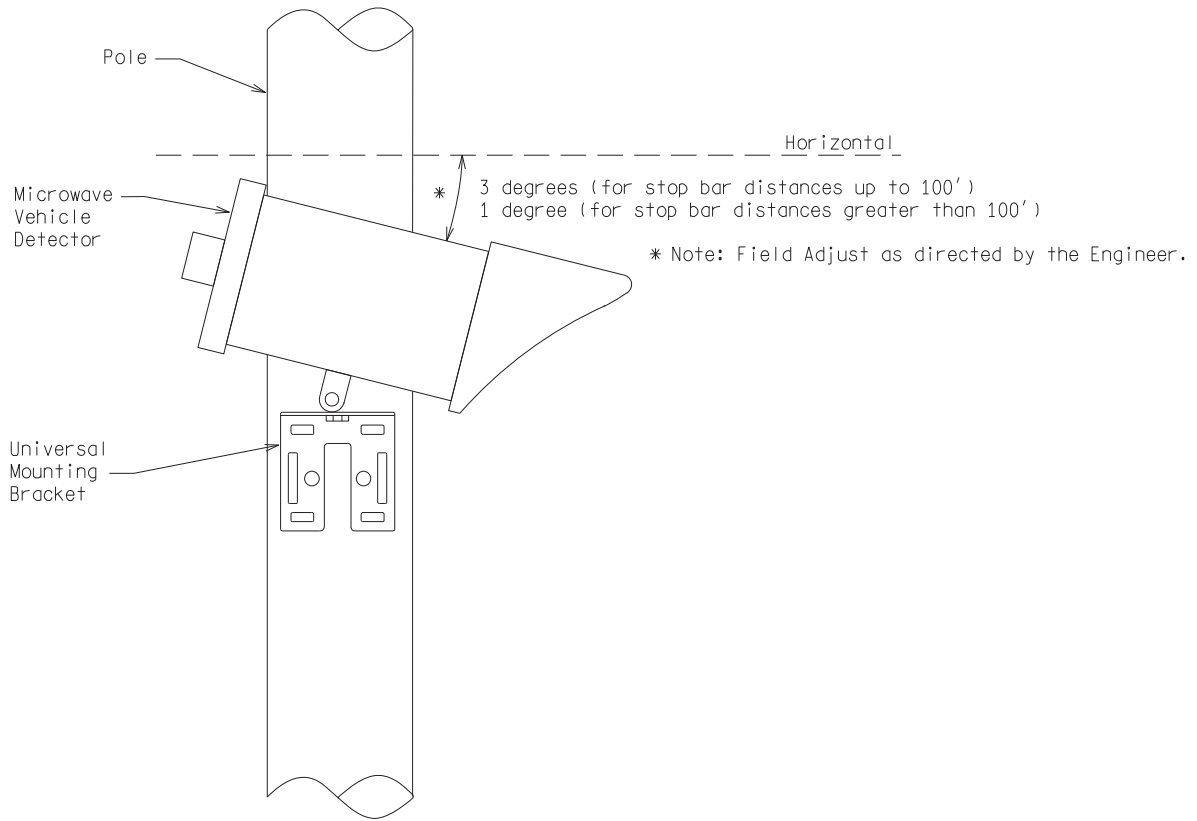

VERTICAL ORIENTATION

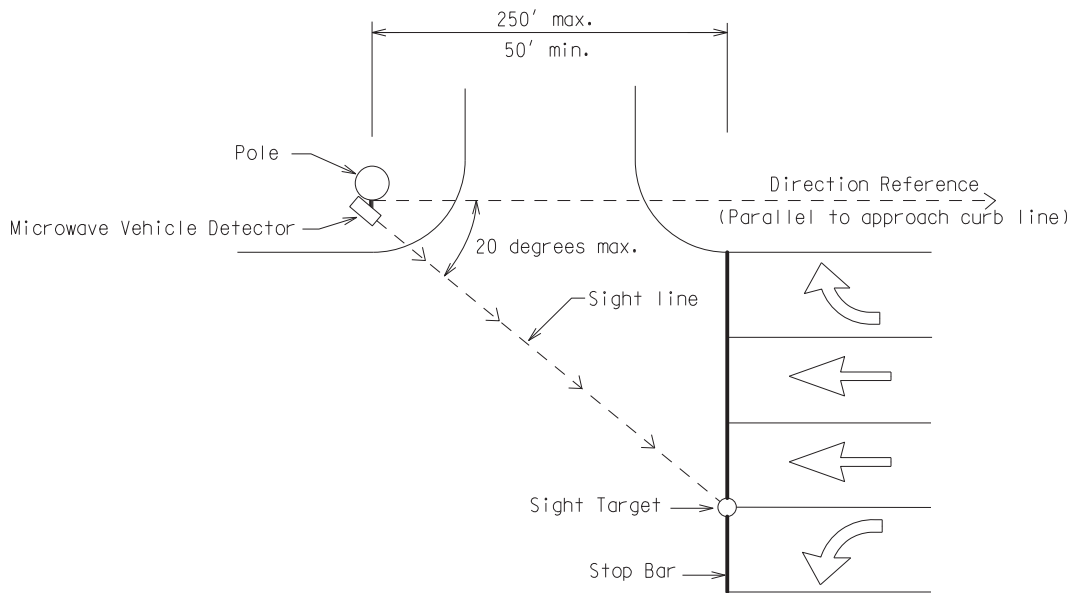

HORIZONTAL ORIENTATION

MICROWAVE VEHICLE SENSOR ORIENTATION DIAGRAM

NOT TO SCALE

MICHIGAN DEPARTMENT OF TRANSPORTATION
BUREAU OF HIGHWAYS DELIVERY STANDARD PLAN

(SPECIAL DETAIL)
FHWA APPROVAL DATE

PLAN DATE

SIG-440-A

SHEET
3 of 4

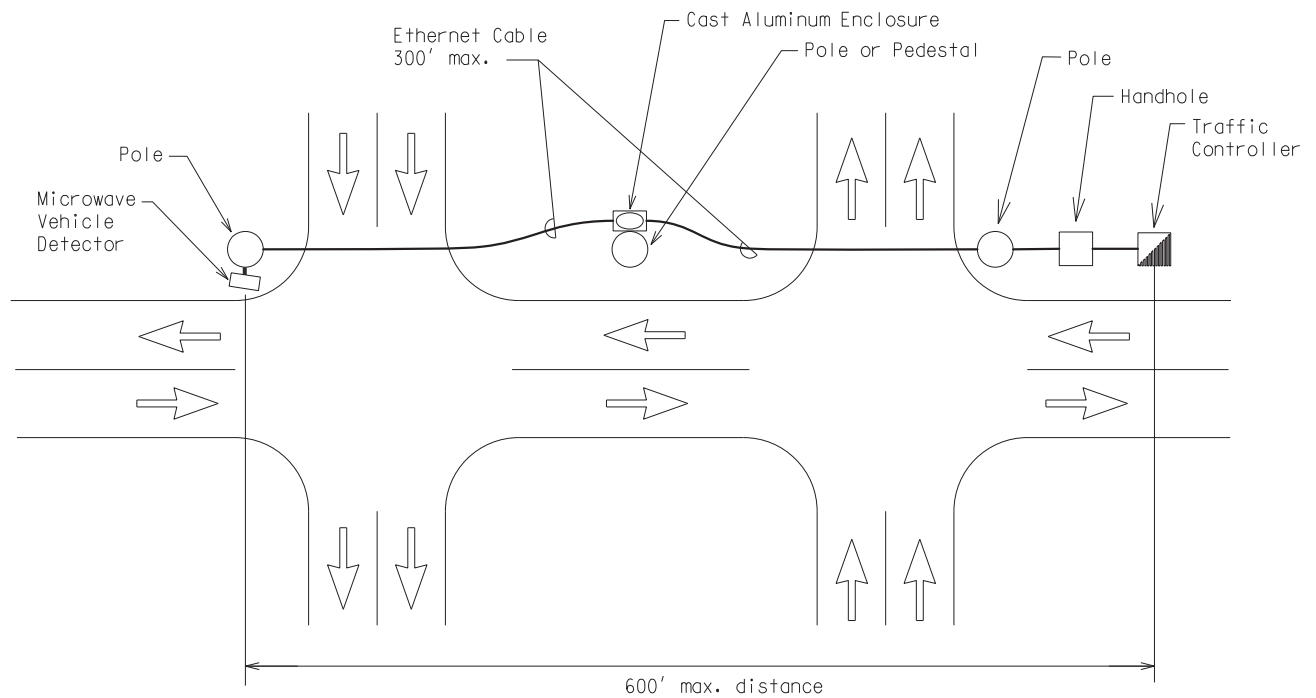
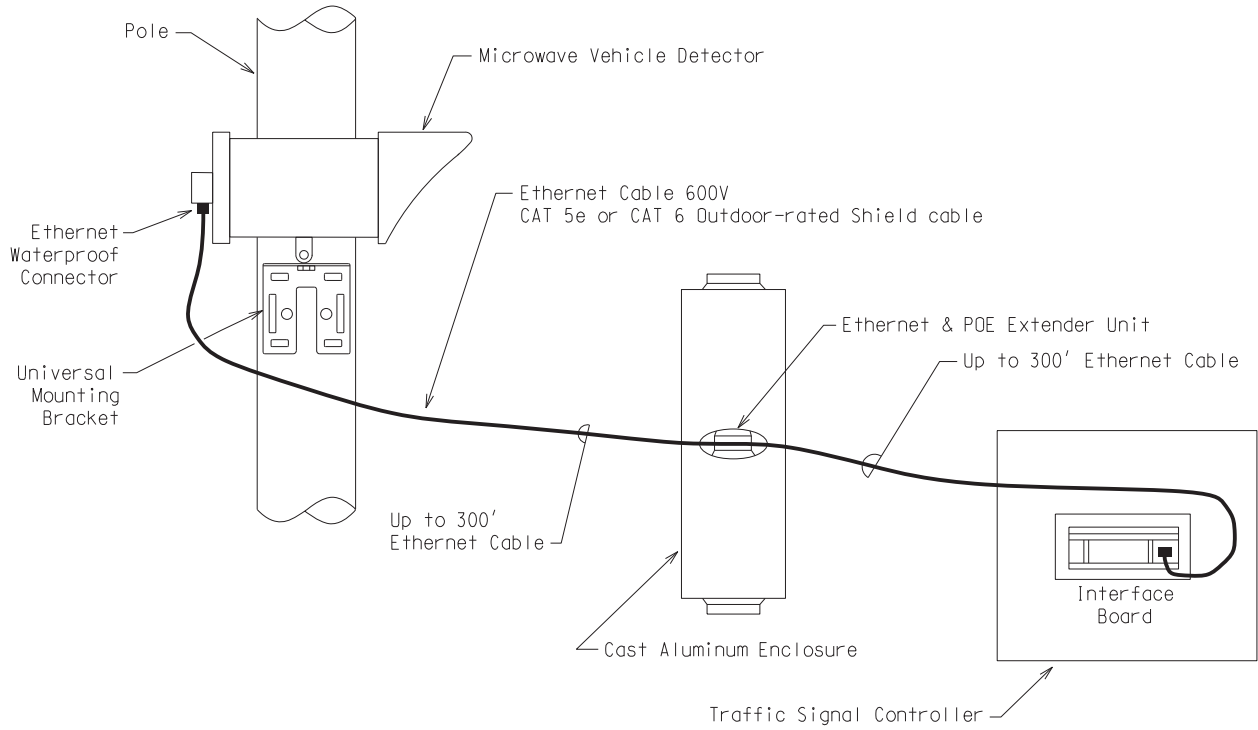

ETHERNET CABLE EXTENSION ORIENTATION DIAGRAM

NOT TO SCALE

MICHIGAN DEPARTMENT OF TRANSPORTATION
BUREAU OF HIGHWAYS DELIVERY STANDARD PLAN

(SPECIAL DETAIL)
FHWA APPROVAL DATE

PLAN DATE

SIG-440-A

SHEET
4 of 4