

**MICHIGAN DESIGN MANUAL
ROAD DESIGN**

CHAPTER 3

INDEX

ALIGNMENT AND GEOMETRICS

3.01 REFERENCES

3.02 DEFINITION OF TERMS

3.03 ALIGNMENT - GENERAL

- A. Horizontal Alignment
- B. Vertical Alignment
- C. Combined

3.03.01 Horizontal Alignment - Design Controls

- A. Minimum Radius
- B. Minimum Curve Lengths
- C. Compound Curves
- D. Sight Distances
- E. Horizontal Curve Computations
- F. Spirals

3.03.02 Vertical Alignment - Design Controls

- A. Minimum / Maximum Grades
- B. Minimum Vertical Curve Lengths
- C. Stopping Sight Distance
- D. Drainage
- E. Other Considerations
- F. Computations

3.04 SUPERELEVATION AND CROSS SLOPES

3.04.01 Point of Rotation

3.04.02 Superelevation Transitions

3.04.03 Superelevation Using a Straight Line Method

3.05 Section Deleted

3.06 DESIGN SPEED

MICHIGAN DESIGN MANUAL

ROAD DESIGN

CHAPTER 3 ALIGNMENT AND GEOMETRICS INDEX (continued)

3.07 GEOMETRICS

3.07.01 Lane Width, Capacity and Vehicle Characteristics

- A. Lane Width and Capacity
- B. Vehicle Characteristics

3.07.02 Interchange Geometrics

- A. Rural and Urban
- B. Interchange Layout
- C. Crossroads Over Freeways
- D. Ramp Radii
- E. Single Lane Ramp Widths

3.07.03 Speed Change Lanes and Transitions

3.07.04 Intersections

3.08 3R, 4R AND OTHER PROJECTS

3.08.01 General

- A. (3R) Resurfacing Restoration and Rehabilitation
- B. (4R) New Construction/Reconstruction
- C. Combined 3R and 4R Work
- D. Other Work Categories
- E. Design Exceptions / Variances
- F. Safety Review / Crash Analysis
- G. National (Truck) Network (NN) Lane Widths

3.09 NON-FREEWAY RESURFACING, RESTORATION, AND REHABILITATION (3R) MINIMUM DESIGN GUIDELINES

3.09.01 General

3.09.02 3R Minimum Guidelines

- A. Non-Freeway, NHS
- B. Non-Freeway, Non-NHS
- C. Design Exceptions / Variances
- D. Section Deleted
- E. Stopping Sight Distance
- F. Horizontal Curve Radius

3.09.03 3R Non-Freeway Safety Considerations

- A. Signing
- B. Evaluation of Guardrail and Bridge Rail
- C. Tree Removal
- D. Roadside Obstacles
- E. Cross Section Elements

MICHIGAN DESIGN MANUAL

ROAD DESIGN

CHAPTER 3 ALIGNMENT AND GEOMETRICS INDEX (continued)

3.09.04 Bridges

3.09.05 Guidelines for Passing Relief Lanes

- A. General
- B. Truck Climbing Lanes
- C. Passing Lane Sections

3.10 NON-FREEWAY RECONSTRUCTION / NEW CONSTRUCTION (4R)

3.10.01 General

3.10.02 Design Criteria

3.10.03 Design Exceptions / Variances

3.11 FREEWAY RESURFACING, RESTORATION, REHABILITATION AND RECONSTRUCTION / NEW CONSTRUCTION (3R/4R) DESIGN CRITERIA

3.11.01 General

3.11.02 Freeway 3R/4R Checklist

- A. Section Deleted
- B. Geometrics and Signing
- C. Section Deleted
- D. Design Exceptions / Variances

3.11.03 Safety Considerations

- A. Section Deleted
- B. Ramp Geometrics and Taper Lengths
- C. Vertical Curbs
- D. Sight Distances
- E. Crown Location/Pavement Cross Slope
- F. Superelevation
- G. Guardrail and Concrete Barrier
- H. Attenuation
- I. Shoulder Cross Slopes
- J. Section Deleted (information moved to Section 3.12)
- K. Clear Zones & Fixed Objects
- L. Culvert End Treatments
- M. Bridges

MICHIGAN DESIGN MANUAL ROAD DESIGN

CHAPTER 3 ALIGNMENT AND GEOMETRICS INDEX (continued)

3.12 UNDERCLEARANCES

- A. 4R Freeway
- B. 4R Arterials
- C. 4R Collectors and Local Routes
- D. 3R Freeway
- E. 3R Arterials
- F. Preventive Maintenance
- G. Vertical Clearance Requirement Table
- H. Design Exception Requirements for Vertical Clearance

3.13 PERFORMANCE BASED PRACTICAL DESIGN

Appendix 3A Geometric Design Elements – New Construction / Reconstruction

Appendix 3B National Network – Federally-Designated Routes

MICHIGAN DESIGN MANUAL ROAD DESIGN

CHAPTER 3

ALIGNMENT AND GEOMETRICS

3.01 (revised 11-28-2022)

REFERENCES

- A. *A Policy on Design Standards - Interstate System*, AASHTO, 2005
- B. *A Policy on Geometric Design of Highways and Streets*, AASHTO, 2018 7th Edition
- C. *Highway Capacity Manual*, 2000, published by Transportation Research Board, National Research Council.
- D. MDOT Geometric Design Guides
- E. *Michigan Manual of Uniform Traffic Control Devices*, current edition, by the Michigan Department of Transportation
- F. *Roadside Design Guide*, AASHTO, 2006
- G. Standard Plan R-107-Series, Superelevation and Pavement Crowns
- H. MDOT [Sight Distance Guidelines](#)

3.02 (revised 5-23-2022)

DEFINITION OF TERMS

Acceleration Lane - An auxiliary lane, including tapers, for the acceleration of vehicles entering another roadway.

Arterial Road – A roadway which provides a high speed, high volume, network for travel between major points.

Auxiliary Lane – Portion of the roadway adjoining the traveled way for speed change, turning, storage for turning, weaving, truck climbing, passing and other purposes supplementary to through-traffic movement.

Average Daily Traffic (ADT) - The average 24 hour traffic volume, based on a yearly total.

Broken Back Curve - Two curves in the same direction joined by a short tangent distance.

Compound Curve - Two connecting horizontal curves in the same direction having different radii.

Collector Road – Roadway linking a Local Road to an Arterial Road, usually serving moderate traffic volumes.

Crash Analysis - A site specific, predictive Highway Safety Manual safety review of crash data performed to identify whether or not a specific geometric design element has either caused or contributed to, or could cause or contribute to a pattern or concentration of crashes at the location in question. The analysis is a critical component used in determining the appropriate application of geometric design criteria and in the evaluation of design exception / variance approval requests.

MICHIGAN DESIGN MANUAL ROAD DESIGN

3.02 (continued)

DEFINITION OF TERMS

Critical Grade - The grade and length that causes a typical truck or other heavy vehicle to have a speed reduction of 10 mph or greater.

Cross Slope – Transverse slope rate of traveled lane or shoulder.

Cross Slope Break - Algebraic difference in rate of adjacent lane cross slopes having slopes in same direction (eg., between thru lanes or thru and auxiliary lanes).

Crown Line Crossover – The algebraic difference in rate of adjacent lane cross slopes at the crown point.

Crown Runout - (also called Tangent Runout) - The distance necessary to remove adverse crown before transitioning into superelevation on curves. (Referred to as “C” distance in Standard Plan R-107-Series.)

Deceleration Lane - An auxiliary lane that enables a vehicle to slow down and exit the highway with minimum interference from through traffic.

Design Hour Volume (DHV) - The hourly volume used to design a particular segment of highway.

Directional Design Hour Volume (DDHV) - The directional distribution of traffic during the DHV.

Free Access Highway - A highway, with no control of access, usually having at-grade intersections, which may or may not be divided.

Freeway - A divided arterial highway with full control of access and grade separations at intersections.

3.02 (continued)

Gore Area - The "V" area immediately beyond the convergence or divergence of two roadways bounded by the edges of those roadways.

Grade Separation - A structure that provides for highway traffic to pass over or under another highway or the tracks of a railway.

Horizontal Clearance – An operational offset providing clearance for external vehicle components such as mirrors on trucks and buses and for opening curbside doors of parked vehicles. A minimum 1'-6" horizontal clearance from the face of curb to an obstruction is required on curbed roadways. If the roadway and curb are separated by a shoulder, the shoulder width is included as part of the clearance.

Interchange - A system of interconnecting roadways in conjunction with grade separations providing for the interchange of traffic between two or more intersecting roadways.

Level of Service - A qualitative measure describing operational conditions within a traffic stream; generally described in terms of such factors as speed and travel time, freedom to maneuver, traffic interruptions, comfort and convenience, and safety. Levels of service are given letter designations, from A to F, with LOS A representing the best operating conditions and LOS F the worst.

Local Road – A road which serves primarily to provide access to farms, residences, business, or other abutting properties.

MICHIGAN DESIGN MANUAL ROAD DESIGN

3.02 (continued)

DEFINITION OF TERMS

Passing Lane Section (PLS) - Extra lane(s) to provide additional capacity and reduce delay caused by slow moving vehicles, such as recreational vehicles, during peak periods. These are often desirable in areas where slower vehicles are not necessarily the result of long steep grades.

Passing Relief Lane (PRL) - Common, all-inclusive reference to a traffic lane provided for increased passing opportunities along a route, can be a Truck Climbing Lane (TCL) or a Passing Lane Section (PLS).

Ramp - A connecting roadway between two intersecting roadways, usually at grade separations.

Reverse Curve – Horizontal curves in the opposite direction joined by a short tangent distance or common point.

Roll-over - Algebraic difference in rate of cross slope between traveled lane and shoulder.

Safety Review - A general safety review of a project performed to identify potential safety enhancements within the limits of a proposed 3R or 4R project.

Service Road (also Frontage Road) - A roadway usually parallel and adjacent to a highway which provides access to abutting properties by separating local and through traffic.

Sight Distance - The unobstructed distance that can be viewed along a roadway - usually referenced to decision points for drivers.

3.02 (continued)

Spiral Curve Transition - A variable radii curve between a circular curve and the tangent. The radii of the transition and the curve are the same at the curve and increase to infinity at the tangent end of the transition.

Superelevation – The banking of the roadway in the direction of the curve to help counter balance the centrifugal force on the vehicle.

Superelevation Transition (sometimes referred to as superelevation runoff) – The distance needed to change the pavement cross slope in the direction of the curve from a section with adverse crown removed to a fully superelevated section, or vice versa. (Referred to as “L” distance in Standard Plan R-107-Series.)

Truck Climbing Lane (TCL) - An extra lane for heavy vehicles slowed by the presence of a long steep “critical grade”, that provides passing opportunities for non-slowed vehicles.

Vehicles Per Hour (vph) - A measurement of traffic flow.

MICHIGAN DESIGN MANUAL

ROAD DESIGN

3.03 (revised 1-23-2023)

ALIGNMENT-GENERAL

The geometric design of a roadway consists of horizontal alignment, vertical alignment, and a combination of the two. A properly designed alignment (horizontal and vertical) leads to the safe and efficient movement of all modes of travel.

A. Horizontal Alignment

Horizontal alignment is a major factor in determining safety, driving comfort, and capacity of a highway.

Some important factors to consider when designing for horizontal alignment:

1. Passing sight distance on two-lane, two-way roadways should be maximized.
2. Curves should be as flat as physical conditions permit. Abrupt changes in alignment introduce the element of surprise to the driver and should be avoided.
3. Broken back curves should be avoided because they are unsightly and drivers do not expect succeeding curves to be in the same direction.
4. If possible, the minimum distance between reverse curves should be the sum of the superelevation transitions, outside the curves, plus the crown runout lengths. The crown runout can be eliminated in some situations. See the Geometrics Unit (Design Division) for additional guidance. When it isn't possible to obtain the desired distance between reverse curves, up to 40% of the transition may be placed in the curves.

3.03 (continued)

B. Vertical Alignment

Vertical alignment establishes the profile grade of a proposed road construction project. The grade can be over virgin land as in the case of a relocation project or along an existing roadway, as in the case of a resurfacing project. In either case and in most proposed construction projects, a profile grade should be established.

Obviously a profile grade must always be established for new construction or relocation projects. Most reconstruction and rehabilitation projects will require new profile grades if improvements for sight distance, superelevation, and drainage are included. A simple resurfacing project can usually be constructed without establishing a new vertical alignment.

Establishing the vertical alignment is based on many factors, including terrain, existing conditions, soils, drainage, coordination with the horizontal alignment, location of bridges, culverts, crossroads, design speed, earthwork balance, etc. The Designer must work with available resources such as the Geometrics Unit of the Design Division to provide the best possible vertical alignment. The final product should be safe, functional, aesthetically pleasing, and economical.

MICHIGAN DESIGN MANUAL

ROAD DESIGN

3.03 (continued)

ALIGNMENT-GENERAL

C. Combined

Horizontal and vertical alignments are permanent design elements. It is extremely difficult and costly to correct alignment deficiencies after the highway is constructed.

A proper combination of horizontal and vertical alignment is obtained by engineering study using the following general controls.

1. Vertical curvature superimposed on horizontal curvature, generally results in a more pleasing appearance. Successive changes in profile not in combination with horizontal curvature may result in a series of humps visible to the driver for some distance.
2. Sharp horizontal curvature should not be introduced at or near the top of a pronounced crest vertical curve. This condition may make it difficult for the driver to perceive the horizontal change in alignment. This can be avoided if the horizontal curvature leads the vertical curvature, i.e., the horizontal curve is made longer than the vertical curve.
3. Sharp horizontal curvature should not be introduced at or near the low point of a pronounced sag vertical curve. Because the road ahead would appear to be foreshortened, a relatively "flat" horizontal curve should be used to avoid this undesirable phenomenon.
4. Horizontal curvature and profile should be made as flat as possible at intersections where sight distance along both roads or streets is important.

See Chapter 3 of *A Policy on Geometric Design of Highways and Streets*, AASHTO, 2018 7th Edition for elements of design.

3.03.01 (revised 11-28-2022)

Horizontal Alignment - Design Controls

A. Minimum Radius

The minimum radius is a limiting value of curvature for a given design speed and is determined from the maximum rate of superelevation and the maximum side friction factor. The minimum radius of curvature should be avoided wherever practical. Attempt to use flatter curves, saving the minimum radius for the most critical conditions. The minimum radius (R_{min}) is shown in the Standard Plan R-107-Series superelevation tabulation at the bottom of each column for each design speed. Values for R_{min} are also tabulated for the straight line superelevation table in [Section 3.04.03](#).

B. Minimum Curve Lengths

Curves should be sufficiently long for small deflection angles to avoid the appearance of a kink.

Curves on rural free access trunklines should be at least 500 feet long for a central angle of 5° and the minimum length should be increased 100 feet for each 1° decrease in the central angle. The minimum should be approximately 15 times the design speed with a desirable length of at least 30 times the design speed. For example, a design speed of 60 mph multiplied by 15 gives a minimum curve length of 900'.

MICHIGAN DESIGN MANUAL ROAD DESIGN

3.03.01 (continued)

Horizontal Alignment - Design Controls

C. Compound Curves

Compound curves should be used with caution. Although compound curves give flexibility to fitting the highway to the terrain and other controls, designers should avoid them whenever possible. When curves with considerably different radii are located too close together, the alignment will not have a pleasing appearance. On one-way roads such as ramps, the difference in radii of compound curves is not so important if the second curve is flatter than the first. On compound curves for open highways, the ratio of the flatter radius to the sharper radius should not exceed 1.5 to 1. On ramps the ratio of the flatter radius to the sharper radius may be increased to a 2 to 1 ratio.

D. Sight Distances

Both stopping sight distance and passing sight distance must be considered for two-way roadways. On one-way roadways only stopping sight distance is required. The designer must be aware that both horizontal and vertical alignments need to be considered when designing for sight distance.

From Table 3-1 of *A Policy on Geometric Design of Highways and Streets*, AASHTO, 2018 7th Edition stopping sight distance can be determined from design speed.

Design Speed	Stopping Sight Distance (Design)
25	155
30	200
35	250
40	305
45	360
50	425
55	495
60	570
65	645
70	730
75	820

3.03.01 (continued)

For general use in the design of a horizontal curve, the sight line is a chord of the curve and the stopping sight distance is measured along centerline of the inside lane around the curve

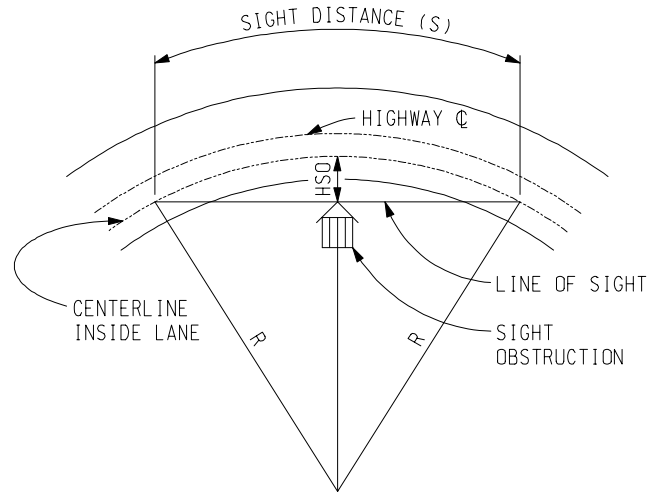

COMPONENTS FOR DETERMINING HORIZONTAL SIGHT DISTANCE

Knowing the stopping sight distance (SSD) and the radius of curve (R) the horizontal sightline offset (HSO) can be calculated from:

$$HSO = R \left(1 - \cos \frac{28.65 SSD}{R} \right)$$

or to verify that SSD is met for a given HSO:

$$SSD = \frac{R \cos^{-1} \left(1 - \frac{HSO}{R} \right)}{28.65}$$

(R, SSD, HSO measured in feet)

These equations are exact only when the vehicle and sight obstruction are within the limits of a circular curve.

MICHIGAN DESIGN MANUAL ROAD DESIGN

3.03.01 (continued)

Horizontal Alignment - Design Controls

When determining sight distances, use ***A Policy on Geometric Design of Highways and Streets***, AASHTO, 2018 7th Edition. The MDOT [Sight Distance Guidelines](#) also provide detailed information on sight distance calculation.

The four types of sight distances given are stopping, passing, decision, and intersection.

1. Stopping Sight Distance is defined as the sight distance available on a roadway that is sufficiently long to enable a vehicle traveling at or near the design speed to stop before reaching a stationary object in its path.
2. Passing Sight Distance is defined as the length needed to complete a passing maneuver as described in ***A Policy on Geometric Design of Highways and Streets***, AASHTO, 2018 7th Edition.
3. Decision Sight Distance is the distance required for a driver to detect an unexpected or otherwise difficult-to-perceive information source or condition in a roadway environment that may be visually cluttered, recognize the situation or its potential threat, select an appropriate speed and path, and initiate and complete the required maneuver safely and effectively.

3.03.01 (continued)

4. Intersection Sight Distance is the distance that allows drivers sufficient view from a minor road to safely cross or turn on a major road.

Generally 7.5 seconds of entering sight distance is used for passenger vehicles stopped on a minor road grade of 3% or less to turn left onto a two-lane roadway. An additional 0.5 seconds is added for each additional lane

Adjustments for other varying conditions that may increase or decrease the time gap are provided in ***A Policy on Geometric Design of Highways and Streets***, AASHTO, 2018 7th Edition.

The designer is cautioned that the element of Clear vision for at-grade intersections is very important, for safety reasons, particularly on high speed trunklines.

MICHIGAN DESIGN MANUAL ROAD DESIGN

3.03.01

Horizontal Alignment - Design Controls

E. Horizontal Curve Computations

Δ = Deflection or Central Angle (Delta), degrees

R = Radius of Curve, ft

T = Length of Tangent (P.C. to P.I.
or P.I. to P.T.) = $R \tan (\Delta/2)$, ft

E = External Distance =
 $R [\sec (\Delta/2) - 1]$ or $T \tan (\Delta/4)$, ft

M = Middle Ordinate Distance =
 $R \text{ Versine } (\Delta/2)$ or $E \cos (\Delta/2)$, ft

L = Length of Curve = $\Delta \times R \div 57.2958$, ft

P.C. = Point of Curvature

P.I. = Point of Intersection of Tangents

P.O.C.T. = Point on Curve Tangent

P.T. = Point of Tangency

D = Degree of Curvature =

$$\frac{5729.58}{R \text{ (ft)}} \text{ degrees}$$

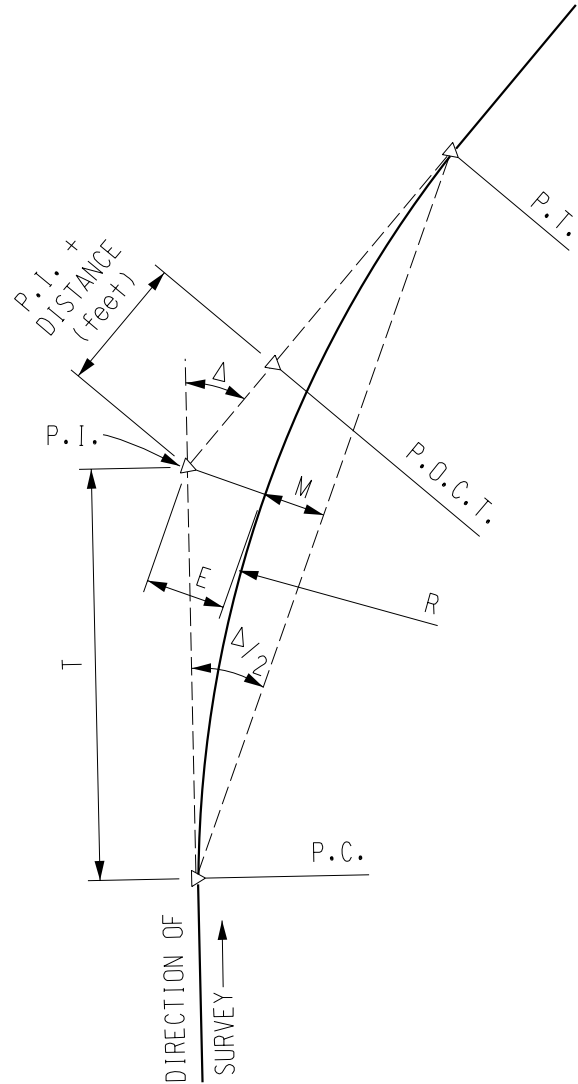

MICHIGAN DESIGN MANUAL ROAD DESIGN

3.03.01

Horizontal Alignment - Design Controls

F. Spirals

Spiral curves are used to transition into circular curves and should be used on new alignments based on the design speed and radius of the curve, as shown on the table in Standard Plan R-107-Series. Spiral curve lengths are normally equal to the superelevation transition length. The relationship between the various elements of spiral curves and their methods of computation are shown below and on the following pages.

Usually the P.I. station and the deflection angle (Δ) are established. The spiral length (L_s) equals the length of superelevation runoff; appropriate values for (L_s) can be obtained using Standard Plan R-107-Series. The remaining curve data can then be computed or read from the tables of spiral curve functions found in the Construction Manual.

- T.S. Sta. = P.I. Sta. - T (Sta.)
- S.C. Sta. = T.S. Sta. + L_s (Sta.)
- C.S. Sta. = T.S. Sta. + L_s (Sta.) + L_{cc} (Sta.)
- S.T. Sta. = T.S. Sta. + $2L_s$ (Sta.) + L_{cc} (Sta.)

The radius of Central Angle (R) should be specified to the nearest 15 feet; all other curve data will be calculated and shown to the nearest one-hundredth of a foot or to the nearest second, whichever is applicable.

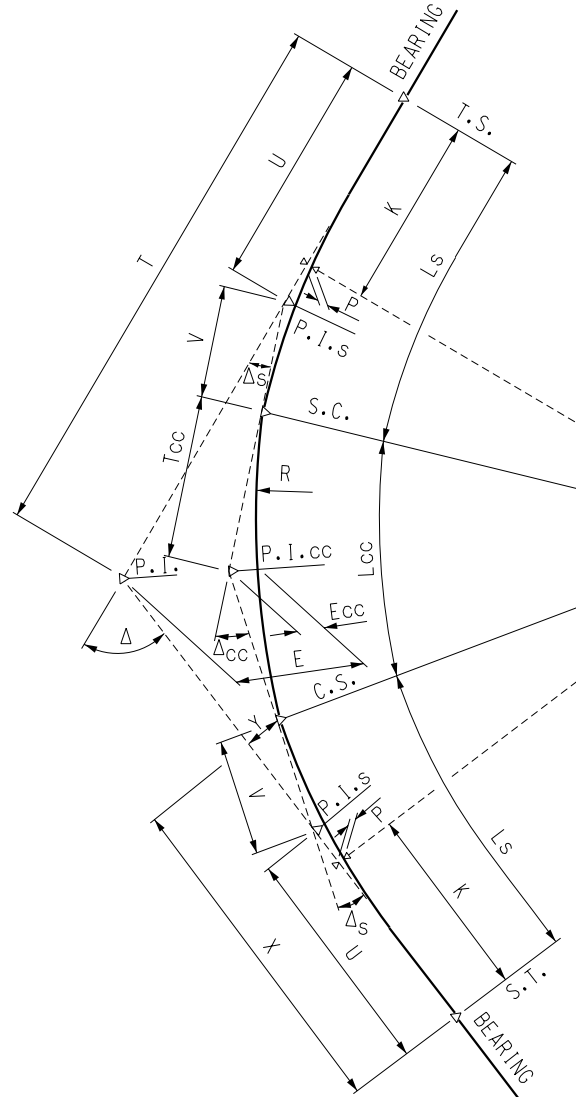

- P.I. = Point of Intersection
- T.S. = Tangent to Spiral
- S.C. = Spiral to Curve
- C.S. = Curve to Spiral
- S.T. = Spiral to Tangent

MICHIGAN DESIGN MANUAL ROAD DESIGN

3.03.01F (continued)

Horizontal Alignment - Design Controls

LEGEND AND FORMULAS FOR SPIRALS

- R = Radius of Central Angle, ft
 T = Tangent Length of Entire Curve, ft
 T_{cc} = Tangent Length of Central Curve, ft
 U = Long Tangent Length of Spiral, ft
 V = Short Tangent Length of Spiral, ft
 L_s = Spiral Length, ft
 L_{cc} = Central Curve Length, ft
 Δ = Deflection Angle of Entire Curve, degrees
 Δ_{cc} = Deflection Angle of Central Curve, degrees
 Δ_s = Deflection Angle of Spiral, degrees
 E = External of Entire Curve, ft
 E_{cc} = External of Central Curve, ft
 X, Y = Coordinates of S.C. (or C.S.) , ft
 K, P = Coordinates of Offset P.C. Referenced the Same as X & Y, ft

$$Throw = P \left(\sec \frac{\Delta s}{2} \right)$$

$$T = (R + P) \tan \frac{\Delta}{2} + K$$

$$E = (R + P) \tan \frac{\Delta}{2} \tan \frac{\Delta}{4} + P$$

T and E may be computed from tables of unit length spirals by taking the corresponding T & E values of the required deflection angle and multiplying them by L_s.

$$V = \frac{Y}{\sin \Delta s}$$

$$U = X - Y \cot \Delta s$$

$$\Delta s = \frac{28.6479 L_s}{R}$$

$$\Delta = \Delta_{cc} + 2\Delta s$$

For Δs Between Zero and 5°

$$Y = L_s \sin \frac{\Delta s}{3}$$

$$X = L_s - \frac{Y^2}{2L_s}$$

$$P = \frac{Y}{4}$$

$$K = \frac{X}{2}$$

For Δs Between 5° and 15°

$$P = L_s \sin \frac{\Delta s}{12}$$

$$Y = 4P$$

$$K = \frac{L_s}{2} - \frac{4P^2}{L_s}$$

$$X = K + R \sin \Delta s$$

MICHIGAN DESIGN MANUAL ROAD DESIGN

3.03.02 (revised 11-28-2022)

Vertical Alignment – Design Controls

Vertical curves are in the shape of a parabola. The basic equation for determining the minimum vertical curve length is:

$$L = KA$$

WHERE:

- L = length of vertical curve, feet
- K = horizontal distance to produce 1% change in gradient, feet
- A = Algebraic difference between the two tangent grades, percent

(Refer to ***A Policy of Geometric Design for Roads and Streets***, AASHTO, 2018 7th Edition for additional Vertical Curve Formulas). Also refer to the MDOT [Sight Distance Guidelines](#) for more detailed information on sight distance calculation.

3.03.02 (continued)

A. Minimum / Maximum Grades

See the “Grade” section of [Appendix 3A](#), the Geometric Design Elements table.

B. Minimum Vertical Curve Lengths

Minimum length (in feet) of a vertical curve should be three times the design speed in mph.

MICHIGAN DESIGN MANUAL ROAD DESIGN

3.03.02 (continued)

Vertical Alignment – Design Controls

C. Stopping Sight Distance

Stopping Sight Distance (SSD) is the principal control of the design of both crest and sag vertical curves. ***A Policy on Geometric Design of Highways and Streets***, AASHTO, 2018 7th Edition gives values for K and lengths of vertical curves for various operational conditions. Values based on reduced design speeds may be used on non-freeway 3R projects. Minimum design guidelines for non-freeway 3R projects are presented in [Section 3.09.02](#). The design speed used for a ramp vertical alignment should meet or exceed the design speed used for the ramp horizontal alignment. See MDOT [Sight Distance Guidelines](#) for more detailed information on sight distance calculation.

D. Drainage

Minimum grades correlate with adequate drainage. A desirable minimum grade is typically 0.5%, but grades of 0.3% may be used for paved roadways. On curbed roadways, when it is necessary to use grades that are flatter than 0.3%, provide enclosed drainage with compensating decreased inlet spacing. In addition, close attention to inlet spacing is critical for sag and crest vertical curves when the K value (rate of grade change) is greater than 167.

Uncurbed roads with ditch drainage can have a level longitudinal grade if the crown adequately drains the pavement. Independent ditches should be used when the grade is less than 0.3%. However, efforts to achieve minimum roadway grades of 0.5% would be of great benefit in the event that future curb and gutter or concrete barrier may be installed.

3.03.02 (continued)

E. Other Considerations

Comfort criteria is sometimes a consideration for sag vertical curves. The equation for length of curve for comfort is:

$$L = \frac{AV^2}{46.5}$$

WHERE:

- L = length of vertical curve, feet
- A = algebraic difference of tangent grades, percent
- V = design speed, mph

Passing sight distance must be considered on two way roadways. Passing sight distance is the distance required for a motorist to safely perform a passing maneuver as described in AASHTO.

Intersection Sight Distance is the distance that allows drivers sufficient view from a minor road to safely cross or turn on a major road. See [Section 3.03.01.D4](#).

F. Computations

The following pages show mathematical details used in the design of vertical curves. This section includes definitions, formulas, and examples.

MICHIGAN DESIGN MANUAL ROAD DESIGN

3.03.02F (continued)

Computations

ELEMENT	ABBREVIATION	DEFINITION
Vertical Point of Curvature	VPC	The point at which a tangent grade ends and the vertical curve begins.
Vertical Point of Tangency	VPT	The point at which the vertical curve ends and the tangent begins.
Vertical Point of Intersection	VPI	The point where the extension of two tangent grades intersect.
Grade	G_1G_2	The rate of slope between two adjacent VPI's expressed as a percent. The numerical value for percent of grade is the vertical rise or fall in feet for each 100 feet of horizontal distance. Upgrades in the direction of stationing are identified as plus (+). Downgrades are identified as minus (-).
External Distance	E	The vertical distance (offset) between the VPI and the roadway surface along the vertical curve.
Algebraic Difference in Grade	A	The value A is determined by the deflection in percent between two tangent grades.
Length of Vertical Curve	L	The horizontal distance in feet from the VPC to the VPT.

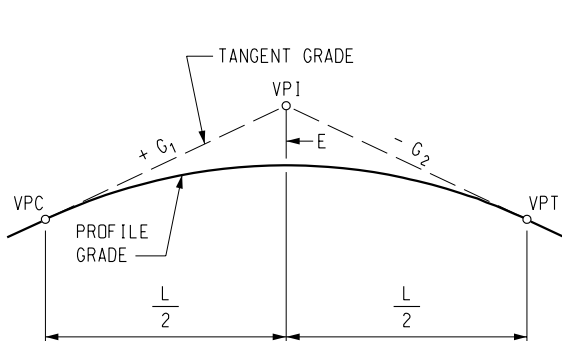

CREST VERTICAL CURVE

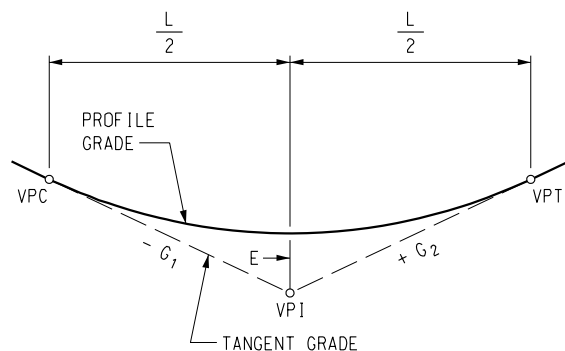

SAG VERTICAL CURVE

MICHIGAN DESIGN MANUAL ROAD DESIGN

3.03.02F (continued)

Computations

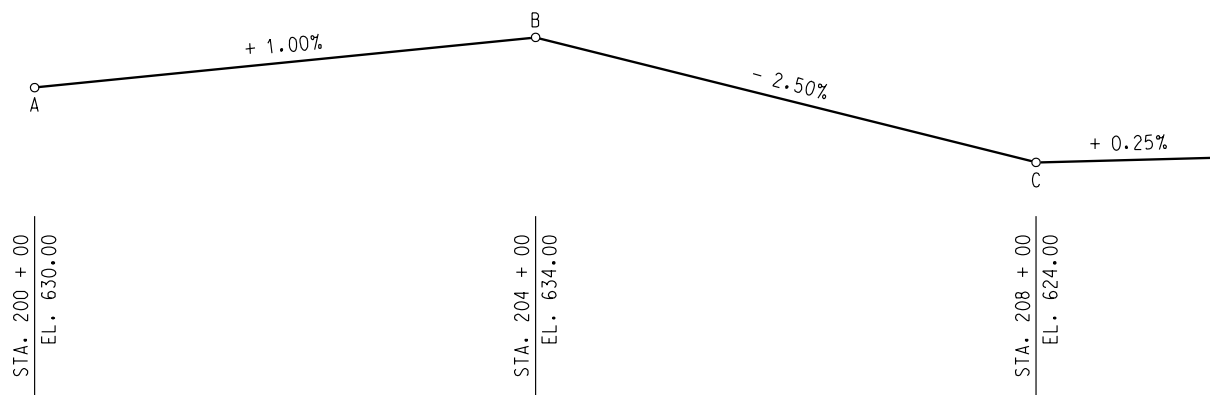

FORMULA: $\frac{\text{DIFFERENCE IN ELEVATION BETWEEN ANY KNOWN STATIONS ON TANGENT}}{\text{DISTANCE BETWEEN THOSE STATIONS}} = \% \text{ GRADE}$

EXAMPLE: GRADE A TO B: $\frac{\text{ELEVATION AT B} - \text{ELEVATION AT A}}{\text{DISTANCE A TO B}} = \frac{634.000 - 630.000}{400} = 1.0\%$

MICHIGAN DESIGN MANUAL ROAD DESIGN

3.03.02F (continued)

Computations

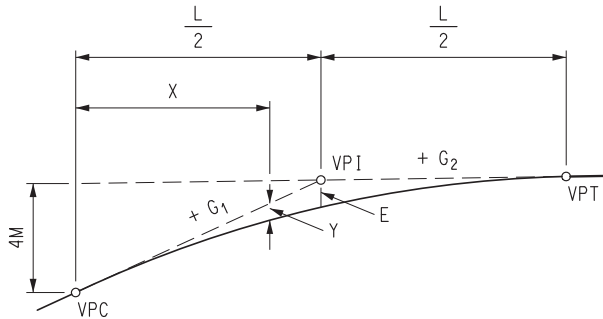

CREST VERTICAL CURVE
FIGURE 1

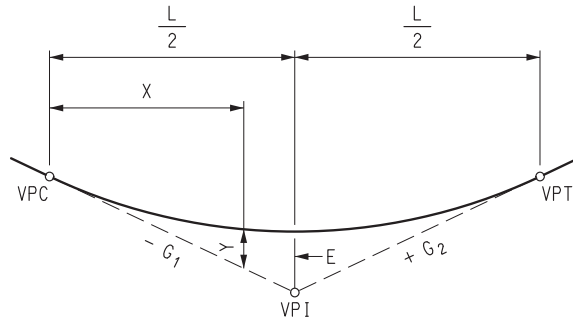

SAG VERTICAL CURVE
FIGURE 2

FORMULAS:

$$E = \frac{A}{800} (L)$$

$$Y = \frac{4M}{L^2} (X^2) \text{ or } \frac{A}{200L} (X^2)$$

WHERE:

E = External distance, feet

A = Algebraic difference of grades (G_1 and G_2), %

L = Length of curve in feet

Y = Offset at distance X from VPC or VPT, feet

GIVEN:

In Figure 1, $G_1 = +4.45\%$ and $G_2 = +1.15\%$. The length of curve $L = 600$ ft. The distance $x = 150$ ft.

REQUIRED: E and offset Y

$$E = \frac{3.3}{800} (600) = 2.48 \text{ ft.}$$

$$Y = \frac{4 \times 2.48}{600^2} (150^2) = 0.62 \text{ ft.}$$

GIVEN:

In Figure 2, $G_1 = -4.55\%$ and $G_2 = +3.00\%$. The length of curve $L = 500$ ft. The distance $x = 150$ ft.

REQUIRED: E and offset Y

$$E = \frac{7.55}{800} (500) = 4.72 \text{ ft.}$$

$$Y = \frac{4 \times 4.72}{500^2} (150^2) = 1.7 \text{ ft.}$$

MICHIGAN DESIGN MANUAL ROAD DESIGN

3.03.02F (continued)

Computations

COMPUTATIONS FOR ODD PI

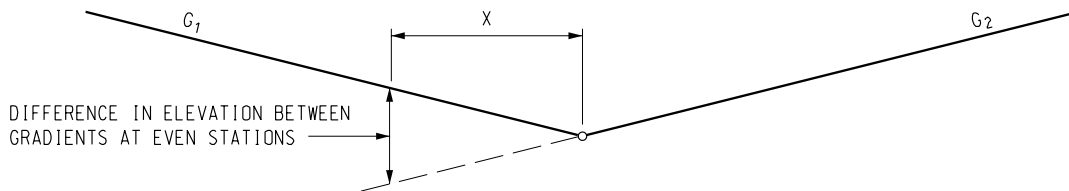

The distance X from any even 100 feet (1 Station) to an odd PI is equal to :

$$\frac{\text{Difference in Elevation at Even Station}}{\text{Algebraic Difference of Gradients}} \times 100$$

GIVEN:

$G_1 = -2.0\%$ and $G_2 = +3.0\%$. Difference in Elevation of 2.5 ft. between gradients at Station 100 + 00.

REQUIRED: Distance X

$$X = \frac{2.5}{5} (100) \quad \text{VPI is at Station } 100 + 50$$

COMPUTATIONS OF LOWEST OR HIGHEST POINT ON VERTICAL CURVE

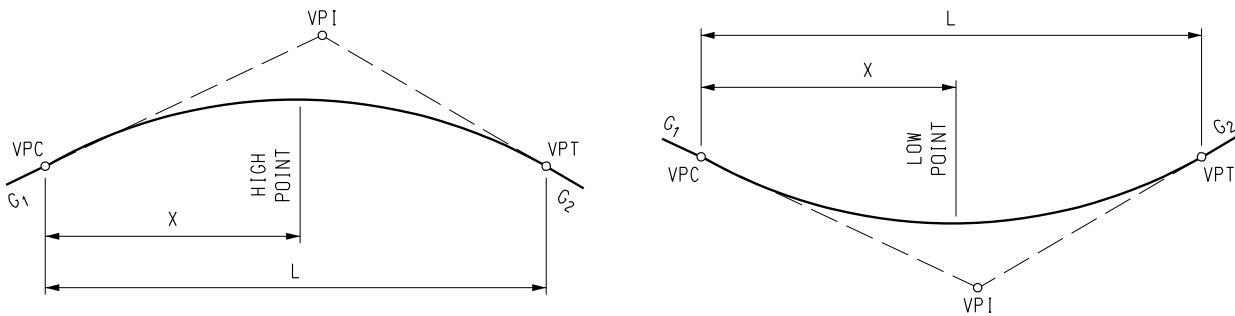

X = Distance to lowest or highest point from VPC in feet

G_1 = % of grade back of VPI

L = Length of vertical curve in feet

A = Algebraic difference of grades

THEN

$$X = \frac{100G_1L}{A}$$

MICHIGAN DESIGN MANUAL ROAD DESIGN

3.03.02F (continued)

Computations

TO FIND % OF GRADE AT ANY POINT ON A VERTICAL CURVE

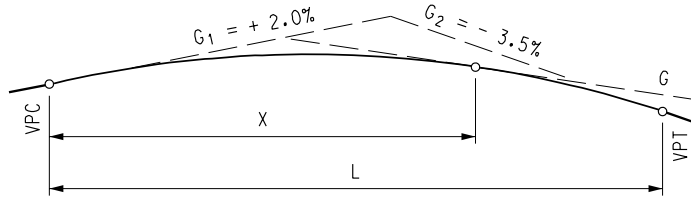

L = Length of vertical curve in feet

x = Distance from VPC in feet

$$a = \frac{G_2 - G_1}{L}$$

Gradient at a point on a curve x distance from VPC

$$G = ax + G_1$$

EXAMPLE:

Find gradient at a point 500 ft. from VPC for a 800 ft. vertical curve.

$$G_1 = +2.0\% \quad L = 800$$

$$G_2 = -3.5\% \quad x = 500$$

$$a = \frac{-3.5 - 2.0}{800} = -0.007$$

$$G = -0.007(500) + 2.0 = -1.50\%$$

Gradient at a point on a curve x distance from VPC

TO FIND A POINT ON CURVE WHERE A GIVEN % OF GRADE OCCURS

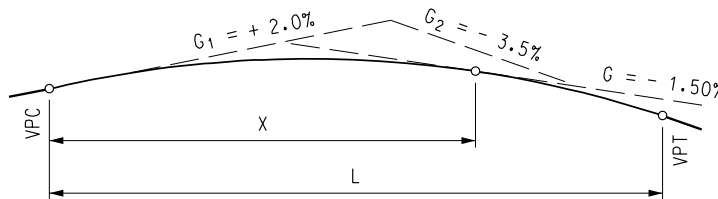

Distance x from VPC to point on selected gradient.

$$x = \frac{G_1 - G}{a}$$

EXAMPLE:

Find point on curve where gradient is -1.50%.

$$G_1 = +2.0\% \quad L = 800$$

$$G_2 = -3.5\% \quad G = -1.50\%$$

$$a = \frac{-3.5 - 2.0}{800} = -0.007$$

$$x = \frac{2.0 + 1.5}{0.007}$$

$$x = 500 \text{ ft.}$$

MICHIGAN DESIGN MANUAL

ROAD DESIGN

3.04 (revised 2-21-2017)

SUPERELEVATION AND CROSS SLOPES

The maximum rate of superelevation is determined from the design speed, curve radii, and the maximum allowable side friction factor.

Michigan, because of its climate, limits superelevation to 7% maximum on rural freeways, free access trunklines, and rural ramps. For maximum superelevation on urban freeways and urban ramps see Standard Plan R-107-Series.

Standard Plan R-107-Series (7% E_{max}) is the preferred method for obtaining superelevation rates. Please note that interpolating between the AASHTO 6% and 8% E_{max} charts to obtain an estimated value for 7% E_{max} criteria is not appropriate. Standard Plan R-107-Series should be used. When it is not possible to use the rates provided in Standard Plan R-107-Series, the straight line method may be used on a curve by curve basis as needed. See [Section 3.04.03](#). This method employs a distribution that generally produces more moderate superelevation rates and uses a maximum rate of superelevation of 6%. If, as a maximum the straight line method cannot be met, a design exception / variance will be required.

3.04 (continued)

The department uses a standard cross slope of 2% as shown on Standard Plan R-107-Series and [Appendix 3A](#) Geometric Design Elements. See [Section 6.09](#) for more information on pavement crowns and cross slope. Also refer to [Section 3.09.02](#) for cross slopes allowable on 3R Projects. A design exception / variance is required when minimum cross slopes are not met and/or when pavement cross slopes exceed 2% except as stated below.

Cross slopes up to and including 2% are barely perceptible in terms of vehicle steering. A maximum cross slope of 2% should be used on the two lanes adjacent to the crownline. This will translate to crownline crossover of 4%.

When three or more lanes are inclined in the same direction on free access curbed highways, each successive lane or portions thereof, outward from the first two lanes adjacent to the crown line, may have an increased slope. The cross slope rate may be increased up to 1%. This helps facilitate parabolic crown modifications when existing side conditions do not allow the preferred uniform standard crown rate. This use of multiple crown rates requires additional transition in superelevated sections. See sketch below.

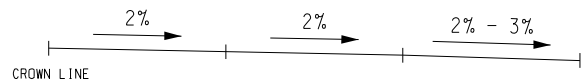

MICHIGAN DESIGN MANUAL ROAD DESIGN

3.04.01 (revised 2006)

Point of Rotation

Superelevation may be obtained by rotating about the center or about inside or outside pavement edge profiles. Currently our crowned two-way and two-lane roadways are rotated about the pavement centerline per Standard Plan R-107-Series. This method reduces the edge distortion because the required change in elevation is distributed along both pavement edges rather than all on one edge. Uncrowned or straight cross slope pavements, such as ramps, are rotated about the alignment edge. Special consideration should be given to superelevating wider pavements (i.e., three-lane or five-lane sections) as the point of rotation should be determined by site conditions. See Standard Plan R-107-Series.

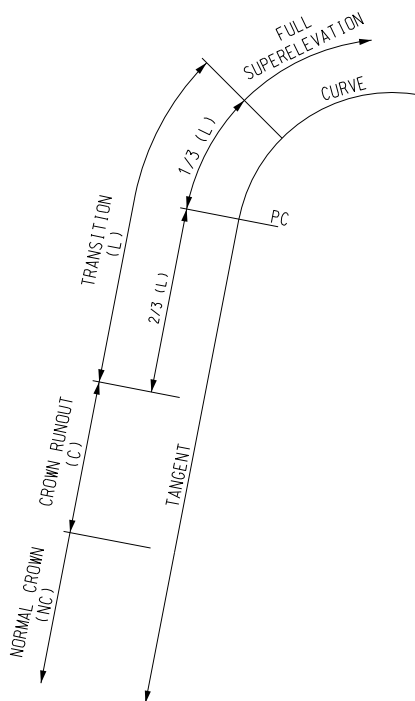

3.04.02 (revised 2-21-2017)

Superelevation Transitions

The superelevation transition consists of the superelevation runoff (or transition (L)) and tangent runoff (or crown runoff (C)). The superelevation runoff section consists of the length of roadway needed to accomplish a change in outside-lane cross slope from zero (flat) to full superelevation, or vice versa. The superelevation runoff is determined by the width of pavement (W), superelevation rate (e), and the relative gradient along the edges of pavement ($\Delta\%$). As indicated in Standard Plan R-107-Series, one third of the superelevation runoff length is located in the curve. When this cannot be achieved, the runoff length can be adjusted to a 30% minimum and 40% maximum inside the curve. The tangent runoff section consists of the length of roadway needed to accomplish a change in outside-lane cross slope from the normal cross slope rate to zero (flat), or vice versa. The tangent runoff is determined by the width of pavement (W), normal cross slope/normal crown (N.C.), and the relative gradient. Relative gradient values correspond to the superelevation rates. The gradient may be increased as needed up to the maximum relative gradient for the design speed. A design variance is required for values exceeding the maximum relative gradient.

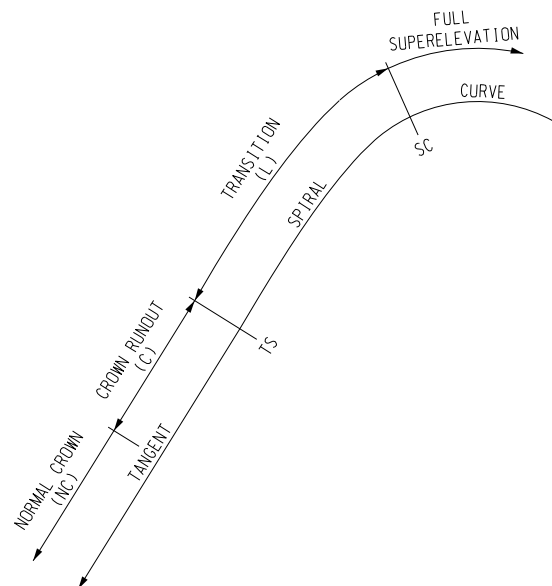

MICHIGAN DESIGN MANUAL ROAD DESIGN

3.04.03 (revised 2006)

Superelevation Using a Straight Line Method

RADIUS Feet		STRAIGHT LINE SUPERELEVATION																				
		30 mph		35 mph		40 mph		45 mph		50 mph		55 mph		60 mph		65 mph		Freeways		Urban Freeways and Urban Ramps		
		e	Δ%	E	Δ%	e	Δ%	e	Δ%	e	Δ%	e	Δ%	e	Δ%	e	Δ%	e	Δ%	e	Δ%	
20000	N.C.	--	N.C.	--	N.C.	--	N.C.	--	N.C.	--	N.C.	--	N.C.	--	N.C.	--	N.C.	--	N.C.	--	N.C.	--
17000	N.C.	--	N.C.	--	N.C.	--	N.C.	--	N.C.	--	N.C.	--	N.C.	--	N.C.	--	N.C.	--	N.C.	--	N.C.	--
14000	N.C.	--	N.C.	--	N.C.	--	N.C.	--	N.C.	--	N.C.	--	N.C.	--	N.C.	--	N.C.	--	N.C.	--	N.C.	--
12000	N.C.	--	N.C.	--	N.C.	--	N.C.	--	N.C.	--	N.C.	--	N.C.	--	N.C.	--	N.C.	--	N.C.	--	N.C.	--
10000	N.C.	--	N.C.	--	N.C.	--	N.C.	--	N.C.	--	N.C.	--	N.C.	--	N.C.	--	N.C.	--	N.C.	--	N.C.	--
8000	N.C.	--	N.C.	--	N.C.	--	N.C.	--	N.C.	--	N.C.	--	N.C.	--	N.C.	--	N.C.	--	N.C.	--	N.C.	--
6000	N.C.	--	N.C.	--	N.C.	--	N.C.	--	N.C.	--	N.C.	--	N.C.	--	N.C.	--	N.C.	--	N.C.	--	N.C.	--
5000	N.C.	--	N.C.	--	N.C.	--	N.C.	--	N.C.	--	N.C.	--	N.C.	--	N.C.	--	N.C.	--	N.C.	--	N.C.	--
4000	N.C.	--	N.C.	--	N.C.	--	N.C.	--	N.C.	--	N.C.	--	N.C.	--	N.C.	--	N.C.	--	N.C.	--	N.C.	--
3500	N.C.	--	N.C.	--	N.C.	--	N.C.	--	N.C.	--	N.C.	--	N.C.	--	N.C.	--	N.C.	--	N.C.	--	N.C.	--
3000	2.0	0.50	2.0	0.45	2.0	0.40	2.0	0.40	2.0	0.40	2.0	0.40	2.0	0.40	2.0	0.40	2.0	0.40	2.0	0.40	2.0	0.36
2500	2.0	0.50	2.0	0.45	2.0	0.40	2.0	0.40	2.0	0.40	2.0	0.40	2.0	0.40	2.0	0.40	2.0	0.40	2.0	0.40	2.0	0.36
2050	2.0	0.50	2.0	0.45	2.0	0.40	2.0	0.40	2.0	0.40	2.0	0.40	2.0	0.40	2.0	0.40	2.0	0.40	2.0	0.40	2.0	0.36
1800	2.0	0.50	2.0	0.45	2.0	0.40	2.0	0.40	2.0	0.40	2.0	0.40	2.0	0.40	2.0	0.40	2.0	0.40	2.0	0.40	2.0	0.36
1675	2.0	0.50	2.0	0.45	2.0	0.40	2.0	0.40	2.0	0.40	2.0	0.40	2.0	0.40	2.0	0.40	2.0	0.40	2.0	0.40	2.0	0.36
1425	2.0	0.50	2.0	0.45	2.0	0.40	2.0	0.40	2.0	0.40	2.0	0.40	2.0	0.40	2.0	0.40	2.0	0.40	2.0	0.40	2.0	0.36
1350	2.0	0.50	2.0	0.45	2.2	0.41	2.9	0.43	3.7	0.44	4.7	0.44	5.9	0.45								
1150	2.0	0.50	2.0	0.45	2.5	0.42	3.4	0.45	4.3	0.46	5.5	0.46										
1075	2.0	0.50	2.0	0.45	2.7	0.43	3.6	0.46	4.7	0.47	5.9	0.47										
850	2.0	0.50	2.4	0.47	3.4	0.46	4.5	0.49	5.9	0.50												
820	2.0	0.50	2.5	0.47	3.5	0.47	4.7	0.49														
800	2.0	0.50	2.6	0.47	3.6	0.47	4.8	0.50														
720	2.0	0.50	2.8	0.49	4.0	0.49	5.4	0.52														
650	2.1	0.51	3.1	0.50	4.5	0.51	5.9	0.54														
600	2.3	0.51	3.4	0.51	4.8	0.53																
500	2.8	0.53	4.1	0.54	5.8	0.57																
450	3.1	0.54	4.5	0.56																		
400	3.5	0.56	5.1	0.58																		
345	4.0	0.58	5.9	0.62																		
300	4.6	0.61																				
232	6.0	0.66																				
Δ% max		0.66		0.62		0.58		0.54		0.50		0.47		0.45		0.43		0.40		0.38		0.45
Rmin	232	340	485	643	833	1061	1333	1657	2042	2500	1412											

Use 7% superelevation for loop ramps (see Standard Plan R-107-Series). However, special consideration should be given to curves which approach a ramp terminal (stopping condition). If relative gradient (Δ%) values from the tables cannot be obtained for the design radius, use Δ%_{max} for the corresponding design speed. For radii less than those tabulated (but not less than Rmin) use e_{max} and Δ%_{max}. Maximum superelevation for urban freeways and urban ramps (with 60 mph design speed) is 5%, otherwise e_{max} = 6%.

MICHIGAN DESIGN MANUAL

ROAD DESIGN

3.05

Section deleted.

3.06 (revised 1-23-2023)

DESIGN SPEED

Design speed is a selected speed used to determine the various geometric design features of the roadway for all modes of travel. Once selected, all of the pertinent design features of the highway should be related to the design speed to obtain a balanced design.

4R projects:

Where practical, it is MDOT desirable practice to design roadway geometrics for new construction or reconstruction based on a recommended project design speed 5 mph greater than the posted speed. This practice is founded in research that shows actual operating speeds are typically greater than the posted speeds. Design speeds shown in [Appendix 3A](#) are applicable for 4R projects.

3R projects:

For freeway 3R projects, the minimum design speed is the design speed approved at the time of original construction or reconstruction, whichever is most recent.

Design speeds used for non-freeway 3R projects are shown in [Section 3.09.02](#). However, if the original posted speed has been raised, the designer may use the design speed approved at the time of original construction or reconstruction, whichever is most recent.

Also See [Section 3.08.01C](#) for information on combined 3R and 4R work.

3.06 (continued)

The project design speed to be recorded on the title sheet is the predominant selected design speed. This will be either the MDOT recommended design speed ([Appendix 3A](#) or [Section 3.09.02A](#) & [3.09.02B](#)) or if applicable, the matched original construction/latest preceding 4R design speed allowed for 3R projects.

If the highest attainable design corresponds to criteria for speeds less than the minimum design speed, a design exception or variance must be submitted for approval. For additional information see [Section 14.11](#).

Documentation must be for each geometric element and not a blanket statement applying to all geometric elements. A design speed reduction for individual geometric elements does not redefine the overall "project design speed".

MICHIGAN DESIGN MANUAL

ROAD DESIGN

3.07

GEOMETRICS

3.07.01 (revised 8-26-2019)

Lane Width, Capacity and Vehicle Characteristics

A. Lane Width and Capacity

The lane width of a roadway greatly influences the safety and comfort of driving. In urban areas, designers should consider the safety of all users when determining lane widths. See [Appendix 3A](#) for lane width information for 4R work and [Section 3.09.02](#) for 3R work.

B. Vehicle Characteristics

There are two general classes of vehicles: passenger and commercial (trucks). The geometric design requirements for trucks and buses are much more severe than they are for passenger vehicles. Consult the Geometrics Unit in the Design Division for the appropriate design vehicle to be used on the job. Intersection radii for various types of commercial vehicles are given on Geometric Design Guide GEO-650-Series, "Flares and Intersection Details". Also, for short radii loops, additional ramp width may be needed to accommodate these vehicles. Generally, the AASHTO WB-67 is the design vehicle to be used in determining the radii to be used in turning movements at trunkline to trunkline intersections and interchanges.

Acceleration and deceleration rates of vehicles are often critical in determining highway design. These rates often govern the dimensions of design features such as intersections, freeway ramps, speed change lanes, and climbing or passing lanes.

3.07.02 (revised 2-24-2020)

Interchange Geometrics

General: Contact the Geometrics Unit in the Design Division for the recommendations / requirements of all geometric features of highway facilities.

A. Rural and Urban

Geometric Design Guides, developed by the Geometrics Unit in the Design Division show approved criteria for ramp and interchange design. See Geometric Design Guides.

B. Interchange Layout

The following items should be considered in conjunction with the Geometric Design Guides for interchange design.

1. Exit ramps should be designed for adequate visibility for the motorist exiting the freeway. Sight distance along a ramp should be at least as great as the design stopping sight distance. There should be a clear view of the entire exit terminal, including the exit nose and a section of the ramp roadway beyond the gore.
2. Exit ramps should begin where the freeway is on a tangent, when possible.
3. Drivers prefer and expect to exit in advance of the structure. Loop ramps that are located beyond the structure, usually need a parallel deceleration lane.
4. Left-hand entrances and exits are contrary to the concept of driver expectancy. Therefore, extreme care should be exercised to avoid left-hand entrances and exits in the designing of interchanges.
5. The geometric layout of the gore area of exit ramps should be clearly seen and understood by the approaching drivers.

MICHIGAN DESIGN MANUAL ROAD DESIGN

3.07.02B (continued)

Interchange Geometrics

6. Potential conflicts with pedestrians and bicycles should be considered when using free flow ramps in urban areas.
7. The cross slope in the gore area between the 2' point and the 22' point should be as flat as practicable and desirably 8% or less. It is also desirable that the algebraic difference in grades between the gore and the adjacent lane be 5% or less to minimize the effect on vehicles inadvertently crossing the gore area. It is recommended that detail grades for the above paved portion of the gore area be provided to verify both cross slopes and algebraic differences. The unpaved portion beyond the 22' point (to the extent the clear zone from each roadway overlaps) should be graded as level with the roadway as practical and be clear of major obstructions. See sketch below.

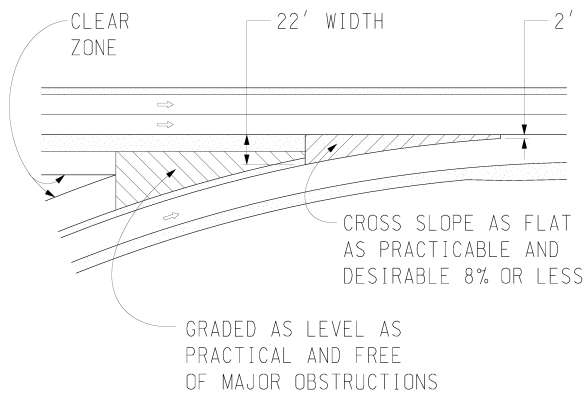

3.07.02B (continued)

8. In order to identify the location of ramps at interchanges, the following system of lettering ramps should be used on projects insofar as possible:

The northeasterly quadrant is designated ramp A. Ramps B, C, & D follow in sequence in a clockwise direction. Interchange interior loops would similarly follow with clockwise designations E, F, G, & H.

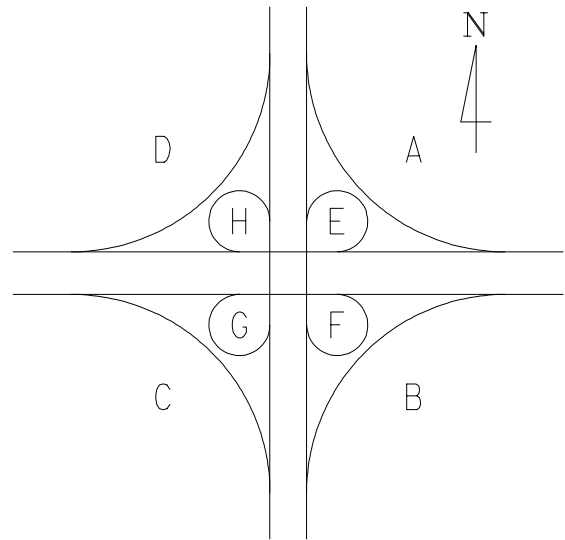

MICHIGAN DESIGN MANUAL ROAD DESIGN

3.07.02 (continued)

Interchange Geometrics

C. Crossroads Over Freeways

Local or county roads over freeways should be designed for stopping sight distance based on the project design speed.

In interchange areas, the intersection sight distance and clear vision areas at diamond ramp terminals must be according to current Department practice. See MDOT [Sight Distance Guidelines, Section 3.03.02E](#) and the Geometric Design Guide GEO-370-Series. The driver's eye position, for a vehicle on a ramp, is assumed to be between 14.5 feet minimum and 18 feet desirable from the edge of the crossroad.

D. Ramp Radii

The speeds at which ramps may be driven, if they are free flowing, is determined primarily by the sharpest curve on the ramp proper. Loop ramps, because of their design restrictions, have the sharpest curvature, and if possible the designer should not use a radius of less than 260 feet. For radii less than 260 feet, contact the Geometrics Unit of the Design Division.

E. Single Lane Ramp Widths

Single lane ramp widths are normally 16'-0". The total paved width including paved shoulders should not exceed 28'. Wider paved widths invite undesirable passing of slow-moving vehicles or invite two-lane operation.

Current ramp widths are shown in Chapter 6, [Appendix 6-A](#).

3.07.03

Speed Change Lanes and Transitions

The change in vehicle speed between highways and ramps is usually substantial, and provision should be made for acceleration and deceleration. Therefore, in order to minimize interference with through traffic on highways, speed change lanes (deceleration and acceleration lanes) are added at turning roadways.

The Geometric Design Guides allow for either parallel or tapered deceleration lanes for exit ramps. Parallel deceleration lanes should be used where the ramp exit is on a freeway curve.

MICHIGAN DESIGN MANUAL ROAD DESIGN

3.07.04 (revised 2006)

Intersections

An intersection is defined as the general area where two or more highways join or cross, including the roadway and roadside facilities for traffic movements within the area.

Intersections are an important part of a highway facility because, to a great extent, the efficiency, safety, speed, cost of operation, and capacity of the facility depends on their design. Although many of the intersections are located in urban areas, the principles involved apply equally to design in rural areas.

The angle of intersection between the approach road and the trunkline should not be less than 60° or more than 120° , with desirable values between 75° and 105° .

The gradient of the intersecting roads should be as flat as practical on those sections that are to be used for storage of stopped vehicles. If possible, side roads should have a "landing" of no more than 3 percent grade. Even though stopping and accelerating distances for passenger cars, on grades of 3 percent or less differ little from the distances on the level, larger vehicles need the flatter landing area.

Where two roadways intersect, crown manipulation of both roadways can be used to improve the drivability of both roadways. In this case, to insure proper drainage, detail grades should be provided. See Geometric Design Guide GEO-650-Series for allowable approach road grades.

3.07.04 (continued)

Intersection sight distance should be provided on all intersections legs. Clear vision corners should be provided when it is practical. See [Section 5.24](#).

Center lanes for left turns or passing flares may be required at certain intersections. See Geometric Design Guide GEO-650-Series.

Ramp terminals should be according to Geometric Design Guide GEO-370-Series.

MICHIGAN DESIGN MANUAL

ROAD DESIGN

3.08

3R, 4R AND OTHER PROJECTS

3.08.01 (revised 1-27-2025)

General

A. (3R) Resurfacing Restoration and Rehabilitation

This work is defined in 23 CFR (Code of Federal Regulations) as "*work undertaken to extend the service life of an existing highway and enhance highway safety. This includes placement of additional surface material and/or other work necessary to return an existing roadway, including shoulders, bridges, the roadside and appurtenances to a condition of structural or functional adequacy. This work may include upgrading of geometric features, such as widening, flattening curves or improving sight distances.*" Examples of this type of work include:

1. Resurfacing, milling or profiling, concrete overlays and inlays (without removing subbase).
2. Lane and/or shoulder widening (no increase in number of through lanes).
3. Roadway base correction.
4. Minor alignment improvements.
5. Roadside safety improvements.
6. Signing, pavement marking and traffic signals.
7. Intersection and railroad crossing upgrades.
8. Pavement joint repair.
9. Crush and shape and resurfacing.
10. Rubblize and resurface.

3.08.01A (continued)

11. Intermittent grade modifications (used to correct deficiencies in the vertical alignment by changing the paving profile for short distances) that leave the existing pavement in service for more than 50% of the total project length.
12. Passing relief lanes.

See [Chapter 12](#) of the Bridge Design Manual for examples of "bridge" 3R work.

B. (4R) New Construction/ Reconstruction

Projects that are mainly comprised of the following types of work are not considered 3R.

1. Complete removal and replacement of pavement (including subbase).
2. Major alignment improvements.
3. Adding lanes for through traffic.
4. New roadways and /or bridges.
5. Complete bridge deck or superstructure replacement.
6. Intermittent grade modifications (used to correct deficiencies in the vertical alignment by changing the paving profile for short distances) that leave the existing pavement in service for less than 50% of the total project length.

The above lists are not all inclusive, but are intended to give typical examples of 3R and 4R work.

MICHIGAN DESIGN MANUAL ROAD DESIGN

3.08.01 (continued)

General

C. Combined 3R and 4R Work

If a project includes 3R and 4R work, the applicable standards are governed by the standards that correspond individually to each work type (3R or 4R). Identify the logical limits of each work type on the project information sheet to distinguish where 3R guidelines and 4R standards are separately applied. Work type overlap between separation limits may cause a default to 4R standards within the overlap.

When other work types are combined with 3R or 4R projects, they are also governed separately and identified as such on the project information sheet. See Section 3.08.01D.

3.08.01 (continued)

D. Other Work Categories

Projects categorized by other work types such as CPM, M-Funded Non-Freeway Resurfacing, Signal Corridor and Signing Corridor projects are governed by guidelines that differ from 3R and 4R Guidelines. For information related to specific requirements for these categories of work, use other appropriate references. When other work types are packaged with a 3R or 4R project, the portion of the project that is outside the 3R or 4R work limits is governed by the guidelines that pertain to the other work type. When describing the work type in the request for Plan Review Meeting, identify the logical limits of work type separation so that the appropriate requirements are considered within those limits. Work type overlap within these separation limits may cause a default to 3R or 4R requirements.

Note that the applicability of CPM minimum design requirements is contingent on the program eligibility of the roadway. Regardless of funding source used to design and construct CPM work, CPM minimum design requirements can only be applied to work done on roadways that would otherwise be eligible for funding under the CPM program.

MICHIGAN DESIGN MANUAL ROAD DESIGN

3.08.01 (continued)

General

E. Design Exceptions / Variances

The sections to follow include standards for geometric design elements for the various classifications of roadways and work types. For specific controlling geometric design elements, a formal design exception must be submitted and approved when the standards cannot be met. Other specific elements and conditions will require a less formal design variance when standards cannot be met.

3.08.01 (continued)

During the review process the Geometric Design Unit will review plans and identify the need for Design Exceptions (DE) or Design Variances (DV) when standards are not met for specified geometric design elements. These elements are listed below with their corresponding level of documentation and/or approval.

Non-Standard Design Element (NHS and Non-NHS) (See Section 3.11.01 for DE Criteria for 3R freeway work)	Applicability of Design Exception (DE) Design Variance (DV)	
	Design Speed	
	≥ 50 MPH	< 50 MPH
Design Speed < Posted Speed	DE	DE
Lane Width*	DE	DV **
Shoulder Width	DE	DV
Horizontal Curve Radius*	DE	DV
Superelevation Rate*	DE	DV
Superelevation Transition*	DV	DV
Maximum Grade*	DE	DV
Stopping Sight Distance (Horizontal and Vertical)*	DE	DV
Cross Slope	DE	DV
Vertical Clearance	DE	DE
Design Loading Structural Capacity	DE	DE
Ramp Acceleration / Deceleration Length*	DV	DV

*Values based on design speeds less than posted.

** Lane width reductions from existing conditions on National Networks require the Design Exception process be followed regardless of design speed.

MICHIGAN DESIGN MANUAL ROAD DESIGN

3.08.01 (continued)

General

Design Exception (DE) - Design Exception requests are submitted on Form [DE26](#) and require approval by the Engineer of Road Design or the Chief Structure Design Engineer. With the exception of low speed (< 50 mph) vertical clearance DE's, subsequent FHWA approval is required for DE elements specifically designated for federal approval in the [Risk Based Project Involvement](#) Stewardship and Oversight (RBPI S&O) plan. Design exceptions should be addressed as early in the life of a design as possible, preferably during the scoping process.

Along with the justification for not meeting MDOT and/or AASHTO standards, the design exception shall include a site-specific Predictive Highway Safety Manual (HSM) Crash Analysis and the estimated total cost required to attain full standards compliance. If a specific HSM model does not exist for that roadway type then perform a crash analysis using crash data for the existing conditions. If a specific Crash Modification Factor (CMF) is not available, contact the Traffic and Safety Section for guidance. Utilize the most recent 5 years of crash data available on RoadSoft for the requested Geometric element. The project Crash Analysis or Road Safety Audit (if required) are not applicable for design exceptions. See [Section 14.11](#) for design exception submittal procedures.

3.08.01 (continued)

Design Variance (DV) – Design Variances are submitted on Form DV26. The procedures and conditions of design variances are as follows:

- Crash analysis review on the element in question.
- Simple justification for not meeting standards (cost, ROW, environmental, etc.)
- If the DV involves a geometric element affected by a bridge, coordination with the Bridge Design Supervising Engineer is required.
- The DV is signed by the Associate Region Engineer of Development affirming that the DV is appropriate.
- The signed DV in ProjectWise completes the DV process.

During QA review of final plan package, if a DV is needed and not provided, the project will not proceed to letting until a DV is provided. If the DV is provided, then the project proceeds. Verification must be indicated on the milestone checklist and the CA form.

When a bridge falls within a road project and no work is planned for the bridge, AASHTO “bridges to remain in place” criteria apply to the bridges. See AASHTO publication, ***A Policy on Design Standards-Interstate System***, 2005 or ***A Policy on Geometric Design of Highways and Streets***, 2018 7th Edition. If the bridge does not meet the criteria to “remain in place” the Road Designer shall be responsible for submitting any necessary, design exceptions or design variances for the bridge.

MICHIGAN DESIGN MANUAL ROAD DESIGN

3.08.01 (continued)

General

F. Safety Review / Crash Analysis

A crash analysis is required for all 3R and 4R projects (See [Section 14.24](#)). The Project Manager should contact the TSC Traffic Engineer during scoping, so that a crash analysis can be performed throughout the project limits. On corridor projects only one analysis that includes roadways and bridges is required. Utilize the most recent 5 years of crash data available on RoadSoft to determine where safety enhancements would be beneficial and supported by the data. Crash Analyses more than 3 years old shall be updated to verify the original results.

A site-specific predictive Highway Safety Manual (HSM) Crash Analysis is required as justification for any design exception or design variance. It is also required in determining appropriate 3R design criteria according to [Section 3.09.02A](#) and [3.09.02B](#). If a specific HSM model does not exist for that roadway type, then perform a crash analysis using the most recent 5 years of crash data available on RoadSoft for the existing conditions and the geometric element in question. Site specific crash analyses more than 3 years old shall be updated to verify the original crash analysis.

3.08.01 (continued)

G. National (Truck) Network (NN) Lane Widths

23 CFR Part 658 requires that lane widths on the Interstate System and portions of the Federal-Aid Primary System are designed to be 12'-0" unless otherwise consistent with highway safety. The portions of the Federal-Aid Primary System that are on the National Network are identified on the [MDOT Truck Operators map](#).

Designers should strive to ensure that all 3R and 4R projects on the National Network have 12'-0" lane widths (excluding turn lanes that would take a vehicle off of the network). Existing truck lane widths that do not meet 23 CFR Part 658 may be retained (not reduced) if they otherwise meet the standards relative to the project work type (3R or 4R).

In rare circumstances, the designer may have to reduce the lane widths on the National Network from existing conditions. This decision should only occur after all other reasonable accommodations have been explored. Because 23 CFR Part 658 requires that National Network lane widths are 12'-0" unless otherwise consistent with highway safety, any reduction from existing widths requires design exceptions with additional evidence that the proposed cross-section will cumulatively improve safety. The design exception must include the following:

- A predictive crash analysis that indicates a decrease in all vehicular, bicycle, and pedestrian serious and fatal crashes over existing conditions.
- Any mitigative measures necessary to ensure the decrease in vehicular, bicycle, and pedestrian serious and fatal crashes.
- An analysis that concludes that a WB-67 is capable of navigating all turns necessary to remain on the National Truck Network without encroaching on adjacent lanes.

Note that all lane width reductions on the National Network must be submitted as a design exception regardless of design speed.

MICHIGAN DESIGN MANUAL ROAD DESIGN

3.09

NON-FREEWAY RESURFACING, RESTORATION AND REHABILITATION (3R) MINIMUM DESIGN GUIDELINES

3.09.01 (revised 8-26-2019)

General

The intent of the 3R guidelines is to extend the useful life of existing roadways and enhance safety while incurring minimal aesthetic and environmental disturbance and economic burden. Often, design guidelines used for new and major reconstruction are not cost effective on 3R projects. Where economically and physically practical, design guidelines should be according to AASHTO requirements to insure the greatest traffic service while taking measures to improve safety for all users, when feasible. The ultimate goal is to improve operating conditions and provide highways that are reasonably safe and fit for all roadway and right of way users.

3R guidelines are divided into three categories that are addressed in subsequent sections of this chapter. These are NHS, Non-NHS and 3R Safety Considerations. They apply strictly to non-freeway applications. Guidelines for freeway 3R and 4R type work are addressed separately in [Section 3.11](#).

3.09.02 (revised 11-28-2022)

3R Minimum Guidelines

Minimum guidelines for controlling design elements shall be according to the following:

MICHIGAN DESIGN MANUAL ROAD DESIGN

3.09.02 (continued)

A. Non-Freeway, NHS

Geometric Elements	Non-Freeway, NHS 3R Minimum Guidelines			
Design Speed (see Section 3.06)	Posted Speed Minimum			
<p style="text-align: center;">Shoulder Width</p> <p><i>Minimum shoulder widths apply for:</i> Rural: Posted speeds greater than 45 mph. Urban: Posted speeds greater than 45 mph where sufficient right-of-way exists to include shoulders. At lower speeds minimum shoulders are desirable.</p>	Current ADT Two-Way		Inside Shoulder	Outside Shoulder
	Two Lane (and three lane when the center lane is a left turn lane)	<750 750 - 5000 >5000 - 10,000 >10,000		3'-0" Gravel 6'-0" (3'-0" Paved) 8'-0" (3'-0" Paved) 8'-0" (7'-0" Paved)
	Multi-Lane Undivided	≤ 10,000 > 10,000		6'-0" (3'-0" Paved) 8'-0" (3'-0" Paved)
	Multi-Lane Divided	≤ 10,000 > 10,000	3'-0" Paved 3'-0" Paved	6'-0" (3'-0" Paved) 8'-0" (3'-0" Paved)
	See Bridge Design Manual Appendix 12.02 for Bridge Widths			
Lane Width	ADT	Lane Width		
	≤750	10'-0"		
	>750	11'-0"		
<p>10'-0" lanes may be considered in urban areas for multi-lane un-divided (regardless of ADT) and multi-lane divided (ADT < 10,000).</p> <p>12'-0" lanes are desirable on the Priority Commercial Network (PCN).</p> <p>12'-0" lanes are required on the National Network (also known as the National Truck Network). Refer to 3.08.01G for retention or reduction of existing National Truck Network lane widths.</p>				
Design Loading Structural Capacity	Rural		Urban	
	Minimum Design Loading HS20.		Minimum Design Loading HS20.	
	(See Bridge Design Manual Appendix 12.02 for other trunkline classifications)			
Horizontal Curve Radius and Stopping Sight Distance	Existing curve radius and stopping sight distance may be retained if the design speed of the existing curve is not more than 15 mph below the project design speed and there is no crash concentration. Otherwise standards for new construction apply. See 2018 7 th Edition AASHTO Green Book or MDOT Sight Distance Guidelines .			
Maximum Grade	Review crash data. Existing grade may be retained without crash concentration.			
Cross Slopes	Traveled way 1.5% - 2%, Shoulder see Section 6.05.05			
Superelevation Rate	Standard Plan R-107-Series or reduced maximum (6%) Straight Line Superelevation Chart using the project design speed.			
Vertical Clearance	See Section 3.12 .			

MICHIGAN DESIGN MANUAL ROAD DESIGN

3.09.02 (continued)

B. Non-Freeway, Non-NHS

Geometric Elements	Non-Freeway, Non-NHS 3R Minimum Guidelines		
Design Speed	Posted Speed Minimum		
<p style="text-align: center;">Shoulder Width</p> <p><i>Minimum shoulder widths apply for:</i></p> <p>Rural: Posted speeds greater than 45 mph.</p> <p>Urban: Posted speeds greater than 45 mph where sufficient right-of-way exists to include shoulders.</p> <p><i>At lower speeds minimum shoulders are desirable.</i></p>	Current ADT Two-Way	Inside and Outside Shoulder Width	
	≤750	2'-0" (Gravel)	
	750 - 2000	3'-0" (Paved)	
	> 2000	6'-0" (3'-0" Paved)	
	Multi-Lane (Divided & Undivided)	Inside (Divided)	Outside (Both sides for un-divided)
	3'-0" Paved	6'-0" (3'-0" Paved)	
	See Bridge Design Manual Appendix 12.02 for Bridge Widths		
Lane Width	ADT	Lane Width	
	≤750	10'-0"	
	>750	11'-0"	
	<p>10'-0" lanes may be considered in urban areas for multi-lane un-divided (regardless of ADT) and multi-lane divided (ADT < 10,000).</p> <p>12'-0" lanes are required for National Network (also known as the National Truck Network). Refer to 3.08.01G for retention or reduction of existing National Truck Network lane widths.</p>		
Design Loading Structural Capacity (Existing Bridges to remain in place)	ADT (Design Year)	Minimum Design Loading	
	0 - 750	H15	
	> 750	HS15	
Horizontal Curve Radius and Stopping Sight Distance	Existing curve radius and stopping sight distance may be retained if the design speed of the existing curve is not more than 15 mph (horizontal) or 20 mph (vertical) below the project design speed and there is no crash concentration. Otherwise standards for new construction apply. See 2018 7 th Edition AASHTO Green Book or MDOT Sight Distance Guidelines .		
Maximum Grade	Review crash data. Existing grade may be retained without crash concentration.		
Cross Slopes	Traveled way 1.5% - 2%, Shoulder see Section 6.05.05		
Superelevation Rate	Standard Plan R-107-Series or reduced maximum (6%) Straight Line Superelevation Chart using the project design speed.		
Vertical Clearance	See Section 3.12 .		

MICHIGAN DESIGN MANUAL ROAD DESIGN

3.09.02 (continued)

3R Minimum Guidelines

C. Design Exceptions / Variances

Non-freeway 3R minimum guidelines should be followed on all non-freeway 3R projects, including Heritage Routes. When non-freeway 3R guidelines are not met for any one or more of controlling design elements (See [Section 3.08.01E.](#)), a request for an exception or variance should be prepared.

When requesting exceptions or variances to design elements on Heritage Routes, it is important to address the fact that the requested exception is based on historic, economic, or environmental concerns for the preservation of the natural beauty or historic nature of the facility.

D. Section Deleted

E. Stopping Sight Distance

Without crash concentrations and/or other geometric features such as intersections, driveways, lane drops, and horizontal curves warranting consideration, existing vertical and horizontal stopping sight distances corresponding to a speed 0 to 15 mph (0 to 20 mph for vertical stopping sight distance on Non-NHS) less than the project design speed may be retained with a supporting site specific crash analysis. However, consideration should be given to re-grading vertical curves where economically and geometrically feasible. A design exception or variance will not be required when an existing vertical curve is improved to meet 3R guidelines on 3R non-freeway projects, with verification that there is no crash concentration attributed to the curve. However, in the presence of a crash concentration, the curve shall be improved to meet 4R guidelines. When entering sight distance is restricted, an appropriate sign warning of the intersection may be installed, including advisory speed panels as needed.

3.09.02 (continued)

F. Horizontal Curve Radius

Without crash concentrations that warrant revision, existing horizontal curve radii corresponding to a speed 0 to 15 mph less than the project design speed may be retained without further documentation.

If the existing horizontal alignment is retained, the operation and safety should be improved to the extent feasible through other elements such as superelevation modifications, removing adverse crown, and removal of sight obstructions to improve stopping sight distance. When the horizontal alignment does not meet the design speed, applicable traffic control devices should be installed according to the *Michigan Manual on Uniform Traffic Control Devices*.

MICHIGAN DESIGN MANUAL

ROAD DESIGN

3.09.03 (revised 5-23-2022)

3R Non-Freeway Safety Considerations

The following additional information serves as guidance for the review of existing and proposed roadside features. Policies on roadside features are not standards and therefore do not require formal design exceptions / variances. When deviations are necessary, a note should be written for the project file. This would not be subject to formal review or approval, however, a note to the design file shall provide the rationale for appropriate alternatives to these guidelines.

A. Signing

Consideration should be given to upgrading sign reflectivity, supports, and locations.

B. Evaluation of Guardrail and Bridge Rail

1. An onsite inspection of height, length, and overall condition should be done to determine guardrail upgrading needs
2. Existing Type A guardrail will be upgraded to current standards (see [Chapter 7](#)) at all locations, except as follows. Type A guardrail which is in good condition may be retained at cul-de-sacs, "T" intersections, and in front of the opening between twin overpassing structures.
3. Blunt ends and turned down endings shall be upgraded to current standard terminals.
4. Unconnected guardrail to bridge rail transitions shall be connected or upgraded to current standards.
5. Existing bridge rail may remain in place if it meets AASHTO static load requirements and has an acceptable crash history. Otherwise, the bridge rail shall be upgraded or retrofitted with three beam guardrail. Note that new rail or complete rail replacement shall meet current standards. See Bridge Design Manual [Section 12.05](#).
6. By Federal mandate, existing Breakaway Cable Terminals (BCT) must be removed on 3R projects on the National Highway System (NHS). See [Section 7.01.41B](#) for upgrading guardrail terminal guidelines.

3.09.03 (continued)

C. Tree Removal

Tree removal will be selective and generally "fit" conditions within the existing right-of-way and character of the road. The 2002 AASHTO *Roadside Design Guide* presents ideal clear zone distance criteria, however, these distances are not always practical in Michigan. Consequently, trees within the clear zone should be considered for removal subject to the following criteria:

1. Crash Frequency

Where there is evidence of vehicle-tree crashes either from actual crash reports or scarring of the trees.

2. Outside of Horizontal Curves

Trees in target position on the outside of curves with a radius of 3000 feet or less.

3. Intersections and Railroad

Trees that are obstructing adequate sight distance or are particularly vulnerable to being hit.

4. Volunteer Tree Growth

Consider removal of volunteer trees within the originally intended tree line. Volunteer trees are those that have naturally occurred since original construction of the road.

5. Maintain Consistent Tree Line

Where a generally established tree line exists, consider removing trees that break the continuity of this line within the clear zone.

6. Clear Zone

See [Section 7.01.11B](#) for Treatment / consideration of obstacles inside the calculated project clear zone. Review crash history for need for spot or corridor improvements.

MICHIGAN DESIGN MANUAL ROAD DESIGN

3.09.03 (continued)

D. Roadside Obstacles

Roadside improvements should be considered to enhance safety and mobility for all users. Improvements may include removal, relocation, redesign, or shielding of obstacles such as culvert headwalls, utility poles, and bridge supports that are within the clear zone as referenced in [Section 3.09.03C](#).

A review of crash history will provide guidance for possible treatments. However, treatment of some obstacles, such as large culverts, can add significantly, perhaps prohibitively, to the cost of a project. This means that in most instances only those obstacles that can be cited as specifically related to crashes or can be improved at low-cost should be included in the project. Ends of culverts that are within the clear zone should be considered for blending into the slope. See *MDOT Drainage Manual*, Section 5.3.5 and Table 5-1.

3.09.03D (continued)

Region Development or the requestor of the project shall address these items in the scope of the project to assure adequate funding for the project. These considerations need to be made at the scoping stage to allow the project to progress smoothly through the design process.

E. Cross Section Elements

1. Crown Location

Existing pavement crown point location may be retained on a project where the rate of resurfacing is less than 4" in thickness. Otherwise, standard crown location should be used.

2. Side Slopes

Use the following chart for side slope rates:

Side Slopes	Review crash history for improvement needs.	Current ADT Two-Way		Foreslope
		≤ 750	> 750	1:3
Two-Lane		≤ 750	> 750	1:3
				1:4
Multi-Lane Undivided		≤ 10,000	> 10,000	1:3
				1:4
Multi-Lane Divided		All		1:4

3. Shoulder Cross Slopes

See [Section 6.05.05](#).

3.09.04

Bridges

In most cases, bridge improvements will include upgrading approach guardrail, guardrail connections, and bridge rails to current Department practices. See [chapter 12](#) of the Bridge Design Manual.

MICHIGAN DESIGN MANUAL ROAD DESIGN

3.09.05 (revised 11-28-2011)

Guidelines for Passing Relief Lanes

A. General

A passing relief lane, which is either a Truck Climbing Lane (TCL) or a Passing Lane Section (PLS), is intended to reduce congestion and improve operations along two-way, two-lane, rural highways. The congestion (platoon forming) being addressed is the result of: (1) speed reduction caused by heavy vehicles on prolonged vertical grades (TCL), and/or (2) slow moving motorists in combination with high traffic volumes or roadway alignment limiting passing opportunities (PLS). Platoons forming behind slow moving vehicles can be reduced or dispersed by increasing the speed or by increasing the opportunities to pass them. The conditions that cause the forming of platoons also restrict the passing opportunities needed to dissipate platoons, thereby increasing congestion.

The construction of Passing Relief Lanes (PRL) is not intended to connect existing multilane sections, but to provide a safe opportunity to pass slower vehicles.

The Geometrics Unit in the Design Division should be contacted to provide assistance in project selection, location, and design based on these guidelines.

B. Truck Climbing Lanes

The presence of heavy vehicles, as defined by the 2000 *Highway Capacity Manual (HCM)*, on two-way, two-lane highway grades cause a problem because traffic is slowed and platoons form simultaneously as passing restrictions increase.

Warranting Criteria (TCL)

(For Information Only)

Initially, design hour volumes (DHV) will be used in identifying candidate locations. Specific classification counts will be requested

3.09.05B (continued)

when required for more comprehensive analysis. FHWA requests that they be advised on any Federal Aid Project in which the 30th high hour is not used as the DHV in warranting a PRL. A combination of the following should be considered in identifying the need for a TCL.

1. Upgrade traffic flow rate exceeds 200 vph
2. Upgrade truck flow rate exceeds 20 vph.
3. One of the following conditions exists:
 - a. Level-of-Service E or F exists on the grade.
 - b. A reduction of two or more levels-of-service is experienced when moving from the approach segment to the grade.
 - c. A typical heavy truck experiences a speed reduction of 10 mph or greater on the grade.

Location Consideration (TCL)

1. TCL's should be:
 - a. On the upgrade side of "critical grades".
 - b. Along sections relatively free from commercial or residential development (driveways) and away from major intersections.

Design Consideration (TCL)

1. The TCL may normally be introduced on the grade some distance beyond the beginning of the upgrade because truck speed will not be reduced enough to create intolerable conditions for following drivers until it has traveled a certain distance up the grade.

MICHIGAN DESIGN MANUAL ROAD DESIGN

3.09.05B (continued)

Guidelines for Passing Relief Lanes

2. TCL's should extend beyond the crest to the point where a truck can attain a speed that is within 10 mph of the speed of other traffic and where decision sight distance when approaching the transition (taper) area is available.
3. The taper beginning a TCL should be at least 500 feet long.
4. The taper length L (feet) is approximately $W \times S$, where W is the shift in feet and S is the posted speed in mph.
5. TCL's should normally be 12'-0" wide.
6. TCL shoulders should be as wide as the shoulders on the adjacent two-lane sections but no less than 4'-0" (3'-0" paved). 4'-0" shoulders shall be limited to areas where wider shoulders are not feasible or environmental concerns prohibit wider shoulders.

C. Passing Lane Sections

Passing Lane Sections (PLS) along two-way, two-lane rural routes are often desirable even in the absence of "critical grades" required for TCL's. PLS's are particularly advantageous where passing opportunities are limited because of traffic volumes with a mix of recreational vehicles and/or roadway alignment. It is preferable to have a four-lane cross section for a PLS, but that is not always feasible because of right-of-way or environmental concerns.

Warranting Criteria (PLS)

(For Information Only)

Initially, design hour volumes (DHV) will be used in identifying candidate locations. Specific classification counts will be requested when required for comprehensive analysis.

3.09.05C (continued)

FHWA requests that they be advised on any Federal Aid Project in which the 30th high hour is not used as the DHV in warranting a PRL. A combination of the following should be considered in identifying the need for a PLS.

1. Combined recreational and commercial volumes exceed five percent of total traffic.
2. The level-of-service drops at least one level and is below Level B during seasonal, high directional splits.
3. The two-way DHV does not exceed 1200 vph. In situations where volumes exceed 1200 vph, other congestion mitigating measures should be investigated.

Location Considerations (PLS)

Desirably, PLS should be located in areas:

1. That can accommodate four lanes (PLS for each direction of traffic) so that the amount of three-lane sections is minimized.
2. With rolling terrain where vertical grades (even though not considered "critical grades") are present to enhance:
 - a. Visibility to readily perceive both a lane addition and lane drop.
 - b. Differential in speed between slow and fast traffic. This occurs on upgrade locations and produces increased passing opportunities.
 - c. Slower vehicles regaining some speed before merging by continuing the PLS beyond the crest of any grade.
3. Relatively free of commercial and/or residential development (driveways) and away from major intersections.

MICHIGAN DESIGN MANUAL ROAD DESIGN

3.09.05C (continued)

Guidelines for Passing Relief Lanes

4. Where radius of the horizontal curve is greater than or equal to 1900 feet.
5. With no restrictions in width resulting from bridges or major culverts, unless structure widening is done in conjunction with PLS construction.
6. That are farther than 750 feet from a railroad crossing.
7. Where directional spacing of approximately 5 miles can be maintained.

Design Considerations (PLS)

1. The beginning and ending transition (tapers) areas of a PLS should be located where adequate decision sight distance is available in advance.
2. The added lanes should continue over the crest of any grade so that slower traffic can regain some speed before merging.
3. The beginning or approach taper should be at least 500 feet long.
4. The taper length L (feet) is approximately $W \times S$, where W is the shift in feet and S is the posted speed in mph.
5. The lane widths on any PLS should normally be 12'-0" wide.
6. PLS shoulders should be as wide as the shoulders on adjacent two-lane sections but no less than 4'-0" (3'-0" paved). 4'-0" shoulders shall be limited to areas where wider shoulders are not feasible or environmental concerns prohibit wider shoulders.
7. The desirable minimum length of any PLS is 1 mile with an upper limit of about 1½ miles.

3.10

NON-FREEWAY RECONSTRUCTION / NEW CONSTRUCTION (4R)

3.10.01

General

"4R" projects are those that require complete reconstruction, new alignment, or the addition of lanes for through traffic.

3.10.02 (revised 8-26-2019)

Design Criteria

Projects are generally designed according to the geometric design elements in [Appendix 3A](#). However, they may become flexible and performance based to more fully address the needs of all transportation modes and the challenges created by funding and ROW constraints. See Section 3.10.03 below to determine when design exceptions / design variances are required.

3.10.03 (revised 8-26-2019)

Design Exceptions / Design Variances

Design Exceptions / Design Variances are required whenever the design criteria given above ([Appendix 3A](#)) cannot be met for controlling design elements (See [Section 3.08.01E](#).)

MICHIGAN DESIGN MANUAL

ROAD DESIGN

3.11 (revised 2006)

FREEWAY RESURFACING, RESTORATION, REHABILITATION AND RECONSTRUCTION / NEW CONSTRUCTION (3R/4R) DESIGN CRITERIA

3.11.01 (revised 11-28-2022)

General

The 3R/4R program applies to freeways, which are defined as divided arterial highways with grade separated intersections and full control of access. Design criteria for Interstate freeways are established in the AASHTO publication, *A Policy on Design Standards-Interstate System*, 2005. Design criteria for non interstate freeways are established in the AASHTO publication *A Policy on Geometric Design of Highways and Streets*, 2018 7th Edition.

Current freeway standards for new construction and reconstruction are shown in [Appendix 3A](#). They may, however, be flexible and performance based to more fully address the needs of all transportation modes and the challenges created by funding and ROW constraints. See Section 3.11.02D to determine when design exceptions / design variances are required. 3R freeway projects, without crash concentrations or overall not experiencing more crashes than expected for the section, must meet or exceed the minimum standards in effect at the time of the last reconstruction (or original construction if not reconstructed) for any of the ten controlling criteria. Increasing the existing value of these elements to levels below that of current 4R criteria will not require a design exception. However, if the 3R freeway project reduces the existing value of any of the ten controlling design elements further below current 4R criteria, a design exception will be required for each element reduced. Note that retaining a parabolic crown on a 3R freeway will still require a design exception (MDOT requirement). See [Section 3.08.01C](#) for information on combined 3R and 4R work.

3.11.01 (continued)

3R/4R freeway projects should be reviewed to determine need for safety improvements such as: alignment modifications, superelevation modifications, sight distance improvements, lengthening ramps, widening shoulders, flattening slopes, increasing underclearances, upgrading guardrail and bridge railings, shielding of obstacles, and removing or relocating obstacles to provide a traversable roadside. (Also see [Section 3.08.01F](#).)

3.11.02 (revised 8-26-2019)

Freeway 3R/4R Checklist

A. Section Deleted

B. Geometrics and Signing

The Project Manager should also contact the Geometrics Unit in the Design Division and the Region Traffic and Safety Engineer to identify desirable enhancements prior to refining the project cost estimate. The Design Division – Traffic Sign Unit should be consulted to identify and coordinate plan preparation for sign upgrading needs.

C. Section Deleted

D. Design Exceptions / Design Variances

Design Exceptions / Design Variances are required whenever the design criteria given in Section 3.11.01 ([Appendix 3A](#) & minimum standards in effect at the time of last reconstruction without crash concentrations) cannot be met for controlling design elements (See [Section 3.08.01E](#).)

MICHIGAN DESIGN MANUAL ROAD DESIGN

3.11.03 (revised 6-28-2021)

Safety Considerations

A. Section Deleted

B. Ramp Geometrics and Taper Lengths

When existing acceleration lanes, deceleration lanes and tapers are shorter than those shown in current MDOT guides, they should be lengthened to conform with the latest Geometric Design Guides. For 4R work, if these distances cannot be achieved, design variances are required (See Section 3.08.01E). For 3R work, the existing length is assumed to be compliant per the geometric requirements for 3R work on freeway projects. No design variance is required. Normally, it is more cost effective to use the parallel design for on and off ramps. The need for additional lanes on the off ramp terminals should be analyzed for capacity improvements. Radii should be checked for adequacy. Gore areas should be flattened where desirable.

C. Vertical Curbs

Vertical curb should be entirely removed on freeway mainlines, high speed turning roadways and collector distributor roads. It should also be removed on other ramps for a minimum distance of 200 feet from the bifurcation or ramp nose.

3.11.03 (continued)

D. Sight Distances

Vertical and horizontal sight distances along the mainline and within the entire interchange area, including ramp terminals, should be reviewed for conformance with current AASHTO guides. See MDOT [Sight Distance Guidelines](#) for more detailed discussion on sight distances.

E. Crown Location/Pavement Cross Slope

Where resurfacing is less than 4", the crown point will be retained in its existing location, but the 2.0% cross slope should be established or maintained.

Where resurfacing is 4" or more, the crown point should be moved to meet current standards by shifting it to the left edge of the outside lane. The 2.0% cross slope should be attained with the total yield kept close to 440 lbs/syd for 4", 550 lbs/syd for 5", etc. by reducing thickness on the median lane. However, this concept of relocating the crownline may not be feasible when the entire pavement is sloped in one direction. The desirable roll-over or algebraic difference between the pavement and shoulder cross slopes is six percent or less. A design exception or variance is required when an existing parabolic crown is retained. Also, see [Section 6.03.04B\(1\)](#) "Crown and Superelevation Modification."

F. Superelevation

Current Standard Plan R-107-Series should be used to upgrade rural freeway projects, when feasible. When it is not possible to use the current Standard Plan R-107-Series, the straight line method may be considered on a curve by curve basis as needed. See [Superelevation Using A Straight Line Method](#) in [Section 3.04.03](#). A design exception or variance is required if neither of these options can be met.

MICHIGAN DESIGN MANUAL ROAD DESIGN

3.11.03 (continued)

Safety Considerations

G. Guardrail and Concrete Barrier

Piers and other obstacles near the center of medians, that are 70'-0" or less in width (edge to edge), will always be shielded from both sides, see Standard Plan R-56-Series. Obstacles in the median, near the edge of pavements, will be shielded from the near side. Shielding the far side will be determined on a project-by-project basis.

When it is not possible to maintain current guardrail offsets and still retain the 2'-0" distance from shoulder hinge line to the front face of guardrail post, it is generally more desirable to provide the additional offset between the guardrail and pavement edge than it is to reduce the offset in order to maintain the 2'-0" distance. The shoulder width can be maximized by using longer posts and relocating the guardrail to the shoulder hinge line. See [Section 7.01.41D](#).

When entire runs of guardrail are replaced, the types of rails for upgrading freeways are the same as those specified in [Section 7.01.12F](#) for new freeways. The term "freeway" includes ramps. However, Type T guardrail on ramps should be transitioned to Type B when near a ramp terminal to avoid obstructing sight distance. See [Section 7.01.41A](#).

3.11.03G (continued)

The need for median barrier will be reviewed with the Geometric Design Unit.

The elimination of guardrail should be considered when economically feasible to flatten slopes, or where fixed objects can be removed or relocated outside the clear zone.

H. Attenuation

Where physical conditions prohibit the use of barriers, but shielding is needed, attenuation devices should be used. Contact the Geometric Design Unit for attenuation design.

I. Shoulder Cross Slopes

See [Section 6.05.05](#).

J. Section Deleted

Underclearance information in this section was moved to [Section 3.12](#).

MICHIGAN DESIGN MANUAL

ROAD DESIGN

3.11.03 (continued)

Safety Considerations

K. Clear Zones & Fixed Objects

The current clear zone criteria specified in [Section 7.01.11](#) should be used when upgrading freeways. Obstacles within these limits should be shielded or removed. Obstacles beyond these limits, but within the recovery area, should be reviewed by the Geometrics Unit in the Design Division.

L. Culvert End Treatments

The ends of culverts located within the clear zone on projects programmed for upgrading shall be according to *MDOT Drainage Manual*, Section 5.3.5.

M. Bridges

See the Bridge Management Unit, Construction Field Services Division for FHWA conformance requirements.

3.12 (revised 5-23-2022)

UNDERCLEARANCES

A. 4R Freeway

Roadway 4R projects on the Freeway System must be designed to meet the current AASHTO vertical clearance requirement of 16'-0" (16'-3" is desired for future overlay of the road). Scoping of projects must include a determination of the most effective means of obtaining the vertical clearance standard. A cost/benefit analysis to determine how best to achieve the standard, either in full or with incremental progress needs to be prepared. The analysis should include the alternatives of obtaining all vertical clearances with the road project, a bridge project, or some combination of road and bridge work to meet the clearance requirements. In many cases it may not be possible to achieve the complete vertical clearance with the proposed road project. If the most efficient plan for meeting the vertical clearance requirement is incremental progress, a design exception will be required. The design exception should be submitted as soon as possible, preferably prior to the submittal of the call for projects. This assures that design is not started on projects that may not be approved. The following is the minimum information required to prepare a vertical clearance analysis. This information is also required if a design exception is submitted.

- Preliminary grades for the bridge and approaches, the route under the structure, and ramps if appropriate.
- Location of existing structure foundations related to the proposed grade changes.
- Impact evaluation on existing drainage.
- Evaluation of any other deficient geometric feature.

MICHIGAN DESIGN MANUAL

ROAD DESIGN

3.12A (continued)

UNDERCLEARANCES

- Determination of ROW needs.
- Impacts on Environment.
- Cost estimates for alternatives to meet vertical clearances.
- Proposed time frame when the remainder of vertical clearance will be achieved (rough estimate)
- Accident analysis where appropriate.
- Soils (cut and fill information) and ground water information.
- Impact on local businesses and residences.
- User costs, constructability, maintaining traffic scheme and maintenance cost.

B. 4R Arterials

On Roadway 4R projects on Arterial systems, where no work is scheduled for the bridges, the bridges are considered existing structures and can be retained if they meet the 14'-6" vertical clearance standard, therefore no design exception is required. The existing clearance must be retained. It must not be reduced. Although not required, an evaluation should be performed to determine how best to achieve the standard, either in full or with incremental progress. Obtaining incremental progress toward the vertical clearance requirement with the road 4R project could prevent other more costly construction with the next major bridge rehabilitation or replacement project.

C. 4R Collectors and Local Routes

Maintain existing vertical clearance and a minimum of 14'-6" (14'-9" is desired on 4R projects if possible.)

3.12 (continued)

D. 3R Freeway

If the existing vertical clearance is not reduced and a crash pattern involving high load hits does not exist on a 3R freeway project, the vertical clearance may be retained without a design exception. However, if the vertical clearance is reduced to a value less than the standard (table value), a design exception will be required. The format for the design exception does not require a detailed evaluation but should include the basis for the request and review of the accident history and high load hits for the structures in the immediate vicinity of the structure.

E. 3R Arterials

On roadway 3R projects on Arterial systems, the bridges are considered existing structures and can be retained if they meet the 14'-0" vertical clearance standard, therefore no design exception is required. The existing vertical underclearance must be retained. Although not required, an evaluation should be performed to determine how best to achieve the standard, either in full or with incremental progress. Obtaining incremental progress toward the vertical clearance requirement with the road 3R project could prevent other more costly construction with the next major bridge rehabilitation or replacement project.

A design exception is required to maintain the vertical clearance below 14'-0". The likelihood of obtaining design exceptions for reducing vertical clearance is extremely remote.

F. Preventive Maintenance

Project scope of work includes but is not limited to road work consisting of thin HMA overlays, pavement grinding, concrete joint repair, slurry seal (shoulders only), and seal coat (shoulders only). Maintain existing vertical clearance. No design exception is required.

MICHIGAN DESIGN MANUAL ROAD DESIGN

3.12 (continued)

UNDERCLEARANCES

G. Vertical Clearance Requirement Table

The desired vertical bridge underclearance should be provided as indicated below. If the desired underclearance cannot be provided, then the minimum underclearance shall be met. Where it is considered not feasible to meet these minimums, a design exception shall be requested. See the vertical underclearance design exception matrix in this section and [Section 12.02](#) of the Bridge Design Manual. Requests to further reduce the underclearance of structures with existing vertical clearance less than indicated in the chart below should be made only in exceptional cases.

VERTICAL CLEARANCE REQUIREMENT TABLE

Route Classification Under the Structure	All Construction (Desired)	New Construction (Min *)	Road 4R Construction (Min *)	Bridge 4R Construction (Min *)	3R Construction (Min *)
Freeways	16'-3"	16'-0"	16'-0"	16'-0"	16'-0" ***
NHS Arterials (Local & Trunkline)	16'-3"	16'-0"	Maintain Existing ** and 14'-6" Min	16'-0"	Maintain Existing ** and 14'-0" Min
Non NHS Arterials (Local & Trunkline)	16'-3"	14'-6"	Maintain Existing ** and 14'-6" Min	Maintain Existing ** and 14'-6" Min	Maintain Existing ** and 14'-0" Min
Collectors, Local Roads & Special Routes ⁽¹⁾	14'-9"	14'-6"	Maintain Existing ** and 14'-6" Min	Maintain Existing ** and 14'-6" Min	Maintain Existing ** and 14'-0" Min

* Minimum vertical clearance must be maintained over complete usable shoulder width.

** Existing vertical clearances greater than or equal to the minimums shown may be retained without a design exception. Vertical clearance reductions that fall below the minimums for new construction require a design exception.

*** Existing vertical clearances may be retained (or increased) without a design exception unless a pattern of high load hits exists. Vertical clearance reductions below the standard (table value) require design exceptions.

Information on the NHS system can be obtained by contacting the Statewide Planning Section, Bureau of Transportation Planning or found on the MDOT Web site at:

<https://www.michigan.gov/mdot/programs/highway-programs/nfc>

⁽¹⁾ Special Routes are in highly urbanized areas (where little if any undeveloped land exist adjacent to the roadway) where an alternate route of 16'-0" is available or has been designated. Bridges located on [Special Routes in Highly Urbanized Areas](#) can be found on the MDOT website.

Ramps and roadways connecting a Special Route and a 16'-0" route require a vertical clearance minimum of 14'-6" (14'-9" desired). Ramps and roadways connecting two 16'-0" routes require a vertical clearance minimum of 16'-0" (16'-3" desired).

Pedestrian bridges are to provide 1'-0" more underclearance than that required for a vehicular bridge. For freeways (Interstate and non Interstate), including Special Route Freeways, the desired underclearance shall be 17'-3" (17'-0" minimum).

A vertical clearance of 23'-0" is required for highway grade separations over railroads. Clearance signs are to be present for structures with underclearance 16'-0" or less (show dimensions 2" less than actual). See <https://mdotjboss.state.mi.us/TSSD/tssdHome.htm> for additional information and guidelines.

For shared use paths (pedestrian and bicycle) the vertical clearance to obstructions, including overhead fencing, shall be a minimum of 8'-6" (10'-0" desired). However, vertical clearance may need to be greater to permit passage of maintenance and emergency vehicles. In undercrossings and tunnels, 10'-0" is desirable for vertical clearance. See AASHTO's Guide for the Development of Bicycle Facilities.

MICHIGAN DESIGN MANUAL ROAD DESIGN

3.12 (continued)

UNDERCLEARANCES

H. Design Exception Requirements for Vertical Clearances

Design Exception Requirements Vertical Clearance

Type of Project	Design Exception Required	Coordination with MTMCTEA Required	MDOT Approval Required by Engineer of Design Programs	FHWA Approval
New and 4R reconstruction work on interstate greater than \$1 million	Yes	Yes	Yes	Yes
New and 4R reconstruction work on Interstate freeways less than \$1 million.	Yes	Yes	Yes	No
New and 4R reconstruction work on Non Interstate freeways greater than \$1 million.	Yes	No	Yes	Yes
New and 4R reconstruction work on Non Interstate freeways less than \$1 million	Yes	No	Yes	No
New and 4R reconstruction work on NHS routes other than freeways greater than \$1 million.	Yes	No	Yes	Yes
New and 4R reconstruction work on NHS routes other than freeways less than \$1 million.	Yes	No	Yes	No
New and 4R reconstruction on Non-NHS Routes	Yes	No	Yes	No
3R work on Interstate System.	Yes	Yes	Yes	<i>Only when negotiated oversight is assigned to FHWA on NHS projects > \$5 million.</i>
3R work on Non- Interstate System.	Yes	No	Yes	
3R work on Non-freeway Routes.	Yes	No	Yes	
Preventive Maintenance Work	No	No	No	No

MTMCTEA - Military Traffic Management Command Transportation Engineering Agency

MICHIGAN DESIGN MANUAL ROAD DESIGN

3.12H (continued)

UNDERCLEARANCES

In addition to normal processing of design exceptions, all proposed design exceptions pertaining to vertical clearance on Interstate routes including shoulders, and all ramps and collector distributor roadways of Interstate to Interstate interchanges will be coordinated with the Surface Deployment and Distribution Command Transportation Engineering Agency (SDDCTEA). All exceptions to the 16'-0" vertical clearance standard on the Interstate System are coordinated with SDDCTEA. The Interstate System designated routes can be found at the FHWA NHS Maps website (https://www.fhwa.dot.gov/planning/national_highway_system/nhs_maps/michigan/index.cfm). This requirement does not apply to Special Routes ⁽¹⁾.

MDOT (or its Consultant) is responsible for coordinating exceptions on all projects regardless of oversight responsibilities. MDOT will send a copy of all requests, and responses, to the FHWA. Michigan Interstate Vertical Clearance Exception Coordination, MDOT [Form # 0333](#), is available from MDOT web site.

3.12H (continued)

Requests for coordination shall be emailed to:
usarmy.scott.sddc.mbx.tea-hnd@mail.mil

Contact with inquiries:
Douglas E. Briggs, P.E., 618-220-5229
douglas.e.briggs.civ@mail.mil
or
Jamie Todt, P.E., 618-220-5216
jamie.l.todt.civ@mail.mil

Physical mailings:
Highways for National Defense
ATTN: SDDCTEA
1 Soldier Way
Scott AFB, IL 62225

Fax: 618-220-5125

MDOT (or its consultant) shall verify SDDCTEA receipt of the request. If no comments are received within ten working days, it may be assumed that the SDDCTEA does not have any concerns with the proposed design exception.

MICHIGAN DESIGN MANUAL ROAD DESIGN

3.13 (added 11-28-2022)

PERFORMANCE BASED PRACTICAL DESIGN

Performance Based Practical Design (PBPD) is a decision-making approach that uses quantitative analyses to guide decision-making through the project development process. It is the combination of Practical Design and Performance-Based Design encompassing the what (economic efficiency) and the how (performance-based, data-driven methodology), either of which is incomplete without the other.

The general premise of PBPD is that proposed improvements should be targeted and right sized based on project specific goals and needs. This philosophy places less emphasis on strict adherence to standards and more significance on safety and mobility performance. PBPD can be utilized in every step of the project development process from planning/scoping to final design. While applicable to any project and can occur at various phases of the project development process some projects will have limited application while more complex such as a total reconstruction will have more opportunities for PBPD applications.

PBPD is a design up philosophy that makes the necessary improvements to a roadway or structure to address specific performance issues. The goal of PBPD is to fix what is broken and to not unnecessarily spend scarce resources solely for the purpose of meeting published standards when those deficient features defined per standards and guidance are not causing safety, mobility, reliability or similar problems. By scrutinizing each element of a project's scope relative to value, need, and urgency, a PBPD approach seeks a greater return on infrastructure investments.

3.13 (continued)

The building blocks of PBPD will be as follows:

- Safety will not be compromised.
- For most projects, the minimum design will be the existing condition.
- Project scoping should focus on addressing specific problems supported by data.
- Design solutions should focus on adherence to the project's scoping package.
- Solutions should be an optimized combination of mobility, operations, and other modes.
- Designs should be consistent with the context of the corridor.
- Designs should strive to maximize benefit/cost.

Appendix 3A
GEOMETRIC DESIGN ELEMENTS
New Construction / Reconstruction

Element	Urban	Rural
Design Speed	Freeway	The greater of posted speed, or 70 mph.
	Non-Freeway (Arterial)	The greater of posted speed, or 50 mph minimum.
	Collector Roads	Posted speed (minimum).
	Freeway	12 ft.
Lane Width	Freeway	12 ft.
	Non-Freeway (Arterial)	<p>12 ft. lanes are desirable and should be used where practical, especially on high-speed arterials. Where 12 ft. lanes are not practical, 11 ft. lanes are often used.</p> <p>Lane widths of 10 ft. may be used in more constrained areas where truck and bus volumes are relatively low, and speeds are less than 35 mph. Auxiliary lanes may be 10 –12 ft.</p> <p>12 ft. lanes on the National Network (NN). Refer to 3.08.01G for retention or reduction of existing National Network lane widths.</p>
	Collector Roads	<p>Through lanes & Auxiliary lanes, 10-12 ft.</p> <p>Industrial Areas 12 ft., but where right-of-way is restricted, 11 ft.</p> <p>Where shoulders are used, see guidelines for Rural Collectors </p>
	Freeway	12 ft.
	Non-Freeway (Arterial)	12 ft.
	Collector Roads	12 ft.
	Freeway	12 ft.
	Non-Freeway (Arterial)	12 ft.
	Collector Roads	12 ft.
	Freeway	12 ft.

*Consider using 12 ft. with substantial truck volumes or frequent agricultural equipment use.

Appendix 3A
GEOMETRIC DESIGN ELEMENTS
New Construction / Reconstruction

Urban & Rural							
Element	Mainline						
	<table border="1" style="width: 100%;"> <tr> <th style="width: 50%;">Median</th> <th style="width: 50%;">Outside</th> </tr> </table>	Median	Outside				
Median	Outside						
	<table border="1" style="width: 100%;"> <tr> <th style="width: 50%;">Left</th> <th style="width: 50%;">Right</th> </tr> </table>	Left	Right				
Left	Right						
Freeway	<table border="1" style="width: 100%;"> <tr> <td style="width: 50%;"> <p>8 ft. (4ft. paved minimum) (8 ft. paved at bridge and barrier sections)</p> <p>For 6 or more lane sections (3 or more lanes directional) use 10 ft. paved minimum and consider 12 ft. paved where truck traffic exceeds 250 DDHV.</p> <p>See Appendix 6-A for shoulder width dimensions in relation to various freeway and ramp cross section elements (edge of lane, hinge point, etc.).</p> </td> <td style="width: 50%;"> <p>10 ft. minimum (paved)</p> <p>Consider using 12 ft. paved where truck traffic exceeds 250 DDHV.</p> </td> </tr> <tr> <td style="width: 50%;"> <p>6 ft. (4 ft. paved minimum)</p> </td> <td style="width: 50%;"> <p>8 ft. (7 ft. paved minimum)</p> </td> </tr> </table>	<p>8 ft. (4ft. paved minimum) (8 ft. paved at bridge and barrier sections)</p> <p>For 6 or more lane sections (3 or more lanes directional) use 10 ft. paved minimum and consider 12 ft. paved where truck traffic exceeds 250 DDHV.</p> <p>See Appendix 6-A for shoulder width dimensions in relation to various freeway and ramp cross section elements (edge of lane, hinge point, etc.).</p>	<p>10 ft. minimum (paved)</p> <p>Consider using 12 ft. paved where truck traffic exceeds 250 DDHV.</p>	<p>6 ft. (4 ft. paved minimum)</p>	<p>8 ft. (7 ft. paved minimum)</p>		
<p>8 ft. (4ft. paved minimum) (8 ft. paved at bridge and barrier sections)</p> <p>For 6 or more lane sections (3 or more lanes directional) use 10 ft. paved minimum and consider 12 ft. paved where truck traffic exceeds 250 DDHV.</p> <p>See Appendix 6-A for shoulder width dimensions in relation to various freeway and ramp cross section elements (edge of lane, hinge point, etc.).</p>	<p>10 ft. minimum (paved)</p> <p>Consider using 12 ft. paved where truck traffic exceeds 250 DDHV.</p>						
<p>6 ft. (4 ft. paved minimum)</p>	<p>8 ft. (7 ft. paved minimum)</p>						
Shoulder Width	Rural						
	Urban						
	Rural						
	Minimum paved shoulder, ft. for specified ADT, vehicles/day						
	Undivided Roadways*						
	<table border="1" style="width: 100%;"> <tr> <td style="width: 50%;">Under 400</td> <td style="width: 50%;">400 to 2000</td> <td style="width: 50%;">Over 2000</td> </tr> <tr> <td style="text-align: center;">4</td> <td style="text-align: center;">6</td> <td style="text-align: center;">8</td> </tr> </table>	Under 400	400 to 2000	Over 2000	4	6	8
Under 400	400 to 2000	Over 2000					
4	6	8					
Non-Freeway (Arterial)	<p>Use 8 ft. right and 4 ft. left for divided arterials. Use full width (8 ft.) on both sides of divided arterials with 3 lanes in each direction.</p> <p>For new construction and reconstruction and when feasible on shoulder widening, the paved shoulder is extended with 1 ft. of aggregate to the shoulder hinge for stabilization.</p> <p>A minimum 4 ft. (3 ft. paved) shoulder or curb and gutter is acceptable adjacent to right turn lanes.</p> <p>* Minimum shoulder widths apply for posted speeds greater than 45 mph. At lower speeds, minimum shoulders are desirable.</p> <p>Where shoulders are used, refer to requirements for rural arterials.</p>						
Collector Roads	Minimum shoulder, ft. for specified ADT, vehicles/day						
	<table border="1" style="width: 100%;"> <tr> <td style="width: 50%;">Under 400</td> <td style="width: 50%;">400 to 2000</td> <td style="width: 50%;">Over 2000</td> </tr> <tr> <td style="text-align: center;">2</td> <td style="text-align: center;">4</td> <td style="text-align: center;">6</td> </tr> </table>	Under 400	400 to 2000	Over 2000	2	4	6
Under 400	400 to 2000	Over 2000					
2	4	6					
	The above ranges apply on uncurbed roads and when shoulders are feasible on curbed roads. A minimum paved width of 1 ft. is desirable.						

**Appendix 3A
 GEOMETRIC DESIGN ELEMENTS
 New Construction / Reconstruction**

Element		Urban & Rural	
Design Loading Structural Capacity (Also see Bridge Design Manual)	Freeway	HL93-Mod/ HS-25	
	Non-Freeway	State Trunkline	HL93-Mod/ HS-25
		Local Roads Over Freeways and State Trunkline	HL93-Mod/ HS-25
		Local Roads and Streets	Design according to county or city standards, HL93-Mod/ HL93/ HS-20 minimum.
Horizontal Curve Radius	Freeway	Use HL93-Mod/ HS-25 for all structures in an interchange regardless of route type	
	Non-Freeway (Arterial)		
	Collector Roads		
	Non-Freeway (Arterial)		
	Collector Roads		

See Standard Plan R-107-Series and Section 3.04.03

**Appendix 3A
GEOMETRIC DESIGN ELEMENTS
New Construction / Reconstruction**

Element	Urban & Rural																			
	Maximum Grade (%) for specified design speed (mph)																			
Freeway	Type of Terrain	50	55	60	65	70	75													
	Level	4	4	3	3	3	3													
	Rolling	5	5	4	4	4	4													
Grades 1% steeper may be provided in urban areas.																				
Maximum Grade	Non-Freeway (Arterial)	Urban					Rural													
		Type of Terrain	30	35	40	45	50	55	60	40	45	50	55	60						
		Level	7	7	7	6	6	5	5	5	5	4	4	3						
	Rolling	9	8	8	7	7	6	6	6	6	5	5	4							
	Collector Roads	Urban					Rural													
		Type of Terrain	20	25	30	35	40	45	50	55	60	20	25	30	35	40	45	50	55	60
Level		9	9	9	9	8	8	7	7	6	7	7	7	7	7	7	6	6	5	
Rolling	12	12	11	10	10	9	8	8	7	10	10	9	9	8	8	7	7	6		
Stopping Sight Distance	Follow 2018 7 th Edition of AASHTO "A Policy on Geometric Design of Highways and Streets" (AKA AASHTO Green Book). The MDOT Sight Distance Guidelines also provide detailed information on sight distance calculation.																			
Cross Slope	Traveled way cross slope = 2.0%, Paved shoulder cross slope = 4.0% (Also see Section 6.05.05)																			
Superelevation Rate	AASHTO Method 5 "Curvilinear Relation" is used for new construction/reconstruction. Maximum rate of 7%. (See Standard Plan R-107-Series.)																			
	AASHTO Method 1 "Straight Line Relation" is allowed when Method 5 is not feasible. Maximum rate of 6%. (See Section 3.04.03)																			
The above methods also apply to urban freeways and urban ramps, except the maximum rate is 5% for 60 mph design speed.																				
Vertical Clearance	NHS										Non NHS									
	Freeway	16'-0"										14'-6"								
	Non-Freeway (Arterial) Collectors & "Special Routes"	16'-0"										14'-6"								
For pedestrian bridges provide 1 ft. additional clearance over non-freeway and 17 ft. minimum under clearance over freeways. A vertical clearance of 23'-0" is required for grade separations over railroads. (See <i>Bridge Design Manual 7.01.08 and Bridge Design Guides 5.2.4.03-04.</i>)																				

MICHIGAN DESIGN MANUAL ROAD DESIGN

Appendix 3B National Network – Federally-Designated Routes

Route	From	To
I-75 Conn	US 24BR Pontiac	I-75.
US 2	WI State Line Ironwood	WI State Line S. of Crystal Falls.
US 2	WI State Line Iron Mountain	I-75 St. Ignace.
US 8	US 2 Norway	WI State Line.
US 10	Ludington	I-75 Bay City.
US 12	IN State Line	I-94 W. Jct. Ypsilanti.
US 23	OH State Line	I-75 Mackinaw City.
US 24	OH State Line	MI 15 Waterford.
US 24BR	US 24 S. of Pontiac	MI 1 Pontiac.
US 27	IN State Line	I-75 S. of Grayling.
US 31	IN State Line	I-75 Mackinaw City.
US 33	IN State Line	US 12 Niles.
US 41	WI State Line	Houghton.
US 45	WI State Line	MI 26 Rockland.
US 127	OH State Line	I-69/US 27 N. of Lansing.
US 131	IN State Line	US 31 Petoskey.
US 141	WI State Line S. of Crystal Falls	US 41/MI 28.
US 223	US 23	US 12/127 Somerset.

**MICHIGAN DESIGN MANUAL
ROAD DESIGN**

Appendix 3B National Network – Federally-Designated Route (continued)

Route	From	To
MI 10	I-375 Detroit	Orchard Lake Road.
MI 13	I-69 Lennon	I-75 Saginaw (via MI 81).
MI 13	I-75 Kawkawlin (via I-75 Conn.)	US 23 Standish.
MI 14	I-94 Ann Arbor	I-96/275 Plymouth.
MI 15	US 24 Clarkston	MI 25 Bay City.
MI 18	US 10	MI 61 Gladwin.
MI 20	US 31 New Era	MI 37 White Cloud.
MI 20	US 27 Mt. Pleasant	US 10 Midland.
MI 21	I-96 near Grand Rapids	I-69 Flint.
MI 24	I-75 Auburn Hills (via I-75 Conn.)	I-69 Lapeer.
MI 24	MI 46	MI 81 Caro.
MI 26	US 45 Rockland	MI 38.
MI 27	I-75	US 23 Cheboygan.
MI 28	US 2 Wakefield	I-75.
MI 32	Hillman	Alpena.
MI 33	Mio	Fairview.
MI 35	US 2/41 Escanaba	US 2/41 Gladstone.
MI 36	US 127 Mason	Dansville.

**MICHIGAN DESIGN MANUAL
ROAD DESIGN**

Appendix 3B National Network – Federally-Designated Route (continued)

Route	From	To
MI 37	MI 55	US 31/MI 72 Traverse City.
MI 37	I-96 Grand Rapids	MI 46 Kent City.
MI 38	US 45 Ontonagon	US 41 Baraga.
MI 39	I-75 Lincoln Park	MI 10 Southfield.
MI 40	MI 89 Allegan	US 31BR/I-196BL Holland.
MI 43	MI 37 Hastings	US 127 Lansing.
MI 46	US 131 Howard City	MI 25 Port Sanilac.
MI 47	I-675 Saginaw (via MI 58)	US 10.
MI 50	MI 43/66 Woodbury	MI 99 Eaton Rapids.
MI 50	US 127 S. Jct	I-75 Monroe.
MI 51	US 12 Niles	I-94.
MI 52	OH State Line	US 12 Clinton.
MI 52	I-96 Webberville	MI 46 W. of Saginaw.
MI 53	MI 3 Detroit	MI 25 Port Austin.
MI 55	US 31 Manistee	I-75.
MI 55	MI 65	US 23 Tawas City.
MI 57	US 131 N. of Rockford	US 27.
MI 57	MI 52 Chesaning	I-75 Clio.
MI 59	US 24 BR Pontiac	I-94.

**MICHIGAN DESIGN MANUAL
ROAD DESIGN**

Appendix 3B National Network – Federally-Designated Route (continued)

Route	From	To
MI 60	MI 62 Cassopolis	I-69/US 27.
MI 61	MI 115	US 27 Harrison.
MI 61	MI 18 Gladwin	US 23 Standish.
MI 63	US 31 Scottdale	I-196.
MI 65	US 23 Omer	MI 55.
MI 65	MI 72 Curran	MI 32.
MI 65	Posen	US 23 N. of Posen.
MI 66	IN State Line	US 12 Sturgis.
MI 66	Battle Creek	MI 78.
MI 66	MI 43/50 Woodbury	MI 46 Edmore.
MI 67	US 41 Trenary	MI 94 Chatham.
MI 68	US 31/131 Petoskey	US 23 Rogers City.
MI 69	US 2/141 Crystal Falls	MI 95 Sagola.
MI 72	US 31/MI 37 Traverse City	US 23 Harrisville.
MI 77	US 2	MI 28 Seney.
MI 78	MI 66	I-69 Olivet.
MI 81	MI 24 Caro	MI 53.
MI 82	MI 37 S. Jct. Newago	US 131.

**MICHIGAN DESIGN MANUAL
ROAD DESIGN**

Appendix 3B National Network – Federally-Designated Route (continued)

Route	From	To
MI 83	Frankenmuth	I-75.
MI 84	I-75	MI 25 Bay City.
MI 89	MI 40 Allegan	US 131.
MI 94	US 41	MI 28 Munising.
MI 95	US 2 Iron Mountain	US 41/MI 28.
MI 104	US 31 Grand Haven	I-96.
MI 115	US 27	MI 22 Frankfort.
MI 117	US 2 Engadine	MI 28.
MI 123	I-75 N. of St. Ignace	MI 28.
MI 142	MI 25 Bay Port	MI 53.
MI 205	IN State Line	US 12 W. of Union.